



MOTOROLA

DL118/D
REV 4

Optoelectronics

Device Data



Introduction	1
Quality and Reliability	2
Selector Guide	3
Optoisolators/Optocouplers Data Sheets	4
SOIC-8 Small Outline Optoisolators Data Sheets	5
POWER OPTO Isolators Data Sheets	6
Discrete Emitters/Detectors Data Sheets	7
Slotted Optical Switches Data Sheets	8
Fiber Optics Data Sheets	9
Emitter/Detector Chips Data Sheets	10
Applications Information	11
Tape and Reel Specifications and Surface Mount Package Information	12
Package Outline Dimensions	13
Appendices	14
Index and Cross Reference	15



MOTOROLA

**OPTOELECTRONICS
DEVICE DATA**

The information in this book has been carefully reviewed and is believed to be accurate; however, no responsibility is assumed for inaccuracies. Furthermore, this information does not convey to the purchaser of semiconductor devices any license under the patent rights to the manufacturer.

Motorola reserves the right to make changes without further notice to any products herein. Motorola makes no warranty, representation or guarantee regarding the suitability of its products for any particular purpose, nor does Motorola assume any liability arising out of the application or use of any product or circuit, and specifically disclaims any and all liability, including without limitation consequential or incidental damages. "Typical" parameters can and do vary in different applications. All operating parameters, including "Typicals" must be validated for each customer application by customer's technical experts. Motorola does not convey any license under its patent rights nor the rights of others. Motorola products are not designed, intended, or authorized for use as components in systems intended for surgical implant into the body, or other applications intended to support or sustain life, or for any other application in which the failure of the Motorola product could create a situation where personal injury or death may occur. Should Buyer purchase or use Motorola products for any such unintended or unauthorized application, Buyer shall indemnify and hold Motorola and its officers, employees, subsidiaries, affiliates, and distributors harmless against all claims, costs, damages, and expenses, and reasonable attorney fees arising out of, directly or indirectly, any claim of personal injury or death associated with such unintended or unauthorized use, even if such claim alleges that Motorola was negligent regarding the design or manufacture of the part. Motorola and  are registered trademarks of Motorola, Inc. Motorola, Inc. is an Equal Opportunity/Affirmative Action Employer.

Power Opto™ is a trademark of Motorola Inc.
ST is a registered trademark of AT&T
Thermal Clad is a trademark of the Bergquist Company.

Printed in U.S.A.

© Motorola, Inc. 1993
"All Rights Reserved"

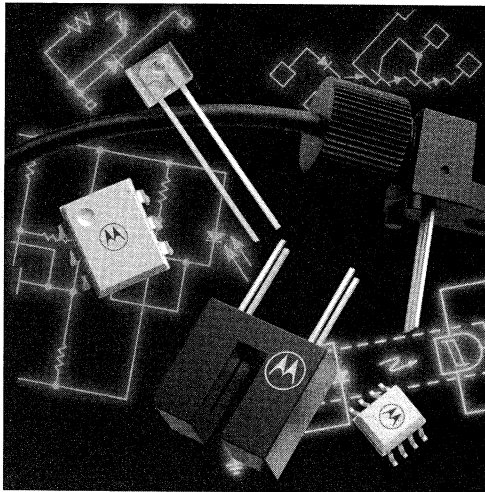

Section One

Introduction

General Product Information	1-2
The Motorola Spectrum of Optoelectronics	1-2
Emitters	1-2
Detectors	1-3
Fiber Optics	1-4
Optoisolators	1-4
Optointerrupters	1-5
Chips	1-5
Custom Optoelectronic Sensing Modules	1-5

General Product Information

Motorola Optoelectronic products include gallium arsenide and gallium aluminum arsenide infrared-emitting diodes, silicon photodetectors, optoisolators, power optoisolators, slotted optical switches and emitters/detectors for fiber optic communication systems. Emphasis is given to custom assemblies for use in specific automotive, industrial and consumer applications.

Technology leadership in optoelectronic products is demonstrated by state-of-the-art 800 volt, zero-crossing triac drivers (MOC3081); the industry's only standard high temperature

Darlington isolator (MOC8080) and the industry's only supplier of standard products with 7500 Vac peak isolation voltage.

The broad optoisolator line includes nearly all the transistor, Darlington, triac driver and Schmitt trigger devices now available in the industry. Motorola optoisolators come in the standard 6-pin DIP package, and the new small outline SOIC-8 style, surface mount package. Each device is listed in the easy-to-use Selector Guide (Section 3) and a detailed data sheet is presented in a succeeding chapter.

The Motorola Spectrum of OPTOELECTRONICS

Optoelectronics is a special branch of semiconductor technology which has come into prominence during the last fifteen to twenty years. Solid state optoelectronic components have proven to be versatile design tools, offering the engineer inexpensive, reliable alternatives to their bulky predecessors.

Solid state light emitting diodes (LEDs) in the visible portion of the electromagnetic spectrum have virtually eliminated the usage of incandescent lamps as panel indicators. Infrared emitters and silicon photodetectors are finding wider application as sensor pairs, replacing electro-mechanical switches. Optoisolators are being designed into circuits previously using small mechanical relays and pulse transformers.

Over the years, solid state optoelectronic technology has advanced dramatically. Research into new and improved materials and processing techniques have led to devices having higher efficiencies, improved reliability, and lower cost.

Emitters

Early emitters, both visible and infrared, suffered from low power output and rapid power output deterioration (degradation) when compared to present day devices. Emitter chip materials, commonly referred to as III-V compounds, are combinations of elements from the III and V columns of the periodic chart. The P-N junction is formed by either diffusing or by epitaxially growing the junction. Typical materials used for emitters include gallium arsenide (GaAs) and gallium aluminum arsenide (GaAlAs), among others.

When a forward bias current (I_F) flows through the emitter's P-N junction, photons are emitted. This is shown schematically in Figure 1. The total output power (P_O) is a function of the forward current (I_F), and is measured in milliwatts. Likewise, the axial radiant intensity (I_O) of an emitting device, which is the portion of the total emitted power radiated within a specified cone angle directly on axis, is also a function of this forward current (I_F), and is measured in milliwatts per steradian.

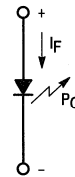

Figure 1. The LED

Motorola's line of emitters operate at wavelengths of either 660, 850 or 940 nanometers (nm). See Figure 2. This encompasses the red and the near infrared portions of the electromagnetic frequency spectrum. Emitters of various wavelengths are produced for the purpose of optimizing system efficiency, when the emitter is operated in conjunction with a variety of applications and environments.

The 940 nm emitters are the most cost effective, however, their spectral emission is not ideally matched to that of the silicon detectors. Most applications can tolerate a certain amount of spectral mismatch, and this sacrifice is generally justified by the devices' lower price. Almost all optoisolators, for example, use the 940 nm emitter.

The 850 nm emitters have a peak emission which almost exactly matches that of silicon. This emitter finds usage in applications where this efficiency, and the emitter's faster speed, are the primary concerns.

The 660 nm emitters are not well matched to silicon, but are ideal for use in plastic fiber optic systems. Plastic fiber has a characteristic attenuation curve which reaches a minimum at 660 nm. This attenuation is the predominant factor to consider when designing a plastic fiber system.

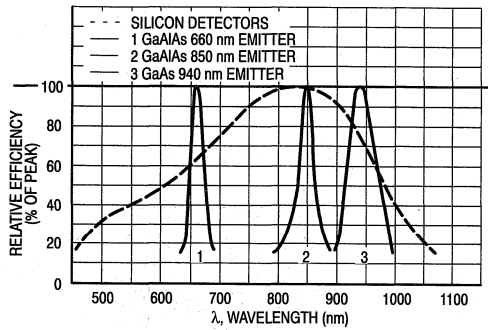

Figure 2. Emissivity versus Wavelength

The above emitters find wide usage in a variety of isolating, sensing, remote control and fiber optic applications.

Newly developed materials and refinements in chip processing and handling have led to more efficient and more reliable emitters. New packaging techniques have made low cost plastic devices suitable for applications formerly requiring glass lensed units, by providing efficient molded-in lenses. In this way, higher on-axis radiant intensities can be achieved, for a given amount of total radiated power. A narrow radiation angle provides for a lower drive current when operating in a configuration where the opto detector is on-axis with the emitter, such as in sensing applications or when launching power into an optical fiber. When a very wide or off-axis viewing angle is required, such as in a remote control situation, emitters with less directional lenses, or unlensed emitters are generally used.

Motorola's selection of emitters includes the low-cost plastic Case 422A devices, such as MLED91, MLED96 and MLED97. Also in a plastic package is the remote control emitter, MLED81.

Metal and glass packages, such as the TO-18 (MLED930) are utilized in applications where high axial intensity or absolute hermeticity are essential.

Advances made in emitter technology over the years have eliminated many of the problems of early-day devices. Even the problem of degradation of emitter power output over time has been brought to a level which is tolerable and predictable. When coupled to a silicon detector, today's devices can be expected to lead a long and useful life.

Detectors

As emitters have developed over the years, photodetectors have also advanced dramatically. Early phototransistors and photodiodes were soon joined by photodarlington detectors, and then by light-activated SCRs. Innovations in design have created devices having higher sensitivity, speed and voltage capabilities. A variety of detectors is shown in Figure 3.

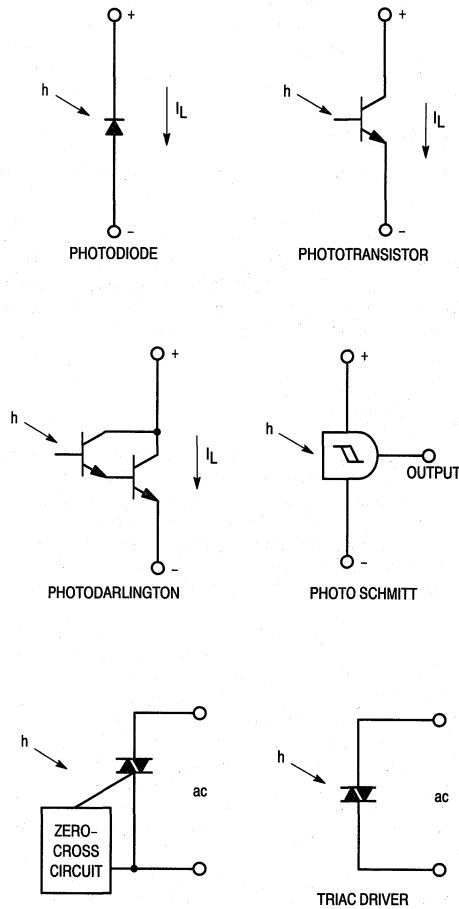

Figure 3. Light Sensitive Detectors

Recent developments in detector technology have led to larger and more complex circuit integration. Photodetectors incorporating Schmitt trigger logic outputs are becoming increasingly popular in applications requiring very fast speed, hysteresis for noise immunity, and logic level outputs.

Motorola introduced the world's first photo-triac driver, a planar silicon device capable of controlling loads on an ac power line. This was followed by the zero-crossing triac driver, also a Motorola development. This device stands as a classic example of opto technology's dramatic progress. Bipolar circuitry, photo-optic technology, high voltage solid state physics and field effect transistor (FET) technology are all incorporated on a monolithic integrated circuit chip inside this device.

Future trends point to even higher performance characteristics and more circuit integration in photodetectors.

Detectors, like emitters, are available in plastic and in lensed metal packages.

Fiber Optics

Motorola offers devices specifically designed for plastic fiber systems.

For low cost plastic systems, Motorola's POF (plastic optical fiber) series is the most economical way to go. Using the MFOE76 emitter, distances of up to 180 meters can be achieved, depending on the MFOD detector which is selected. Convenient termination techniques make the POF system the first truly practical fiber optic system for general purpose usage.

Optoisolators

Optoisolators, a block diagram of which is shown in Figure 4, are devices which contain at least one emitter, which is optically coupled to a photodetector through some sort of an insulating medium. This arrangement permits the passage of information from one circuit, which contains the emitter, to the other circuit containing the detector.

Because this information is passed optically across an insulating gap, the transfer is one-way; that is, the detector cannot affect the input circuit. This is important because the emitter may be driven by a low voltage circuit utilizing an MPU or logic gates, while the output photodetector may be part of a high voltage DC or even an ac load circuit. The optical isolation prevents interaction or even damage to the input circuit to be caused by the relatively hostile output circuit.

The most popular isolator package is the general purpose six-pin DIP, or dual in-line, package. Motorola also offers a small outline surface mountable SOIC-8 package along with 6-pin surface mount leadform options. This offers answers to many problems that have been created in the use of insertion technology. Printed circuit costs are lowered with the reduction of the number of board layers required and eliminates or reduces the number of plated through-holes in the board, contributing significantly to lower PC board prices.

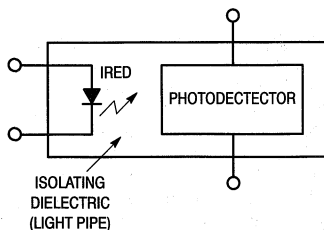

Figure 4. Block Diagram of Optoisolator

Various geometric designs have been used over the years for the internal light cavity between the emitter and detector. Motorola is the industry leader in isolation technology. All 6-pin optoisolators are guaranteed to meet or exceed 7500 Vac (pk) input-to-output isolation. See Figure 5.

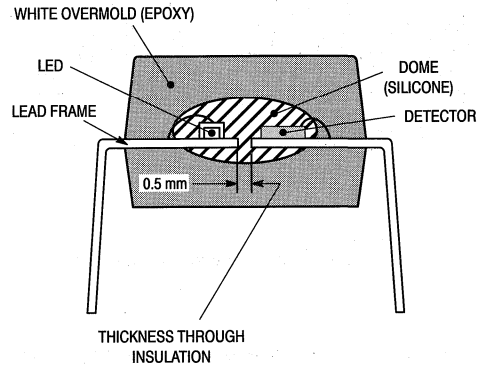

Figure 5. Geometric Design for Optoisolators

The wide selection of photodetectors mentioned earlier is also available in the isolator packages. A variety of optoisolators is shown in Figure 6. With the emitters and detectors both sealed inside an ambient-protected package, the user need not be concerned with any of the optical considerations necessary with separate packages. An important operating parameter of the isolator is efficiency. This parameter defines the amount of input (emitter) current that is required to obtain a desired detector output. In the case of transistor or darlington output isolators, this efficiency is referred to as "current transfer ratio, or CTR. This is simply the guaranteed output current divided by the required input current. In the case of trigger-type isolators, such as one having Schmitt trigger (logic) or triac driver output, efficiency is defined by the amount of emitter current required to trigger the output. This is known as "forward trigger current or I_{FT} .

Efficiency and isolation voltage are two of the most important operating parameters of the optoisolator.

All Motorola six-pin DIP optoisolators are recognized by the Underwriters' Laboratories Component Recognition Program. It should be noted that this recognition extends up to operating voltages of 240 volts ac(rms). Under UL criteria, these devices must have passed isolation voltage tests at approximately 5000 volts ac peak for one second. In addition, Motorola tests every six-pin DIP optoisolator to 7500 vac peak for a period of 1 second. Also, Motorola's six-pin DIP optoisolators are offered in a variety of lead form/trim options. See the section on Package Dimensions for more detailed information.

All Motorola 6-pin optoisolators are approved by VDE, the optoisolator standard which is accepted in most European countries. Check the Motorola data sheet section for specific information on approvals to various VDE norms.

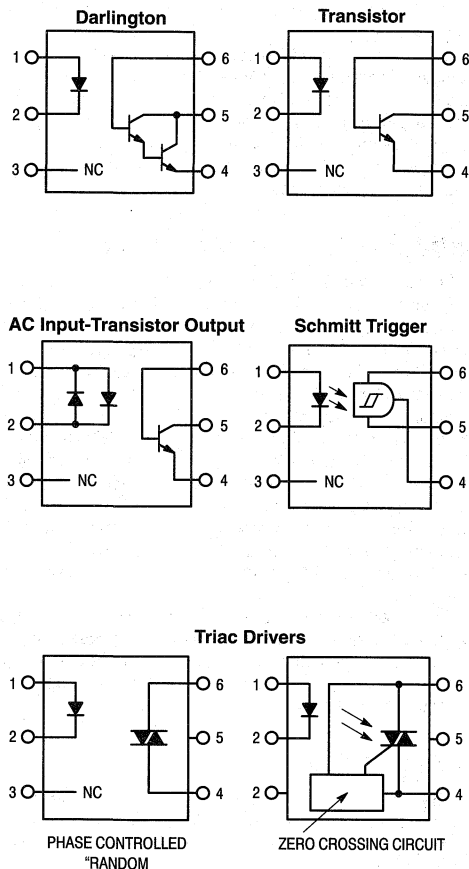

Figure 6. Various Optoisolator Configurations

Opto Interrupters

Assemblies consist of one or more emitters and detectors in a special purpose package. Common assembly configurations include multiple detector arrays, slotted optical switches and reflective optical sensors. A slotted optical switch is a transmissive device made up of an emitter and a detector inserted into a housing. The housing serves to maintain optical alignment between the emitter and detector and to space them apart from one another to form a sensing area, usually an air gap, between them. These devices perform the same function as optoisolators, with the added feature of mechanical interruptibility. This enables them to detect the presence of an object, or its speed, or in the case of a dual-channel device, its direction of travel. Slotted optical switches, also known as interrupters, are available in a variety of package styles to accommodate a range of size and mounting restrictions.

Applications for slotted optical switches include paper sensing in printing and copy machines, cursor controls in video game track balls and computer mice, motor speed tachometer sensors, position sensing in computer disk and tape drivers, and as a replacement for mechanical switches in machine control equipment. Angular position can be monitored as well, by means of an optical shaft encoder.

A reflective optical sensor is another type of opto assembly. This incorporates an emitter and a detector in a common housing, and is designed so that the emitted radiation strikes the target object and reflects back to the detector. While the reflective sensor is somewhat trickier to use than the slotted optical switch, it is popular in locations where there is no access to the opposite side of the target object. It is essential that the operating environment around the reflective sensor be free from unwanted stray light sources and reflective surfaces. Applications include end-of-tape sensing, paper sensing and coin-sensing in vending machines.

Motorola has the capability to produce optical assemblies to many custom configurations. Contact your local Motorola sales office for information on this option.

Chips

Many of the Motorola's emitters and detectors are available in chip form. Please refer to the appropriate section of this Data Book for specific chip information.

Motorola Custom Optoelectronic Sensing Modules

Background

From its inception in 1968, the Motorola Semiconductor Sector's Optoelectronics Operation has grown to be a major, broad-based manufacturer of infrared opto components. Along with discrete gallium arsenide emitters and silicon detectors, the portfolio includes both through-hole and surface mount optoisolators, power control opto units, opto interrupters, fiber optics components and high power optocouplers. Motorola is in the enviable position of being one of the largest

manufacturers of quality optoelectronics components in North America. In 1984, the product offering was further enhanced by the addition of CUSTOM OPTO MODULES.

Why would a Motorola operation which has built a reputation in semiconductor components branch into hybrid assemblies? CUSTOMER SATISFACTION! One of the major automobile manufacturers came to Motorola Opto with a quality problem involving a small, semi-custom device being

purchased from another vendor. Motorola quickly responded and provided a superior part, and ultimately a lower cost. From this innocuous beginning, other applications of a more custom nature opened up and the hiring and staffing of a development group for custom product began. By 1991, Custom Opto Assemblies accounted for a significant portion of the revenue generated by the Optoelectronics Operation.

What Are Custom Opto Modules?

Custom Opto Modules are standard Motorola Optoelectronics components packaged together with additional signal conditioning circuitry in a customized mechanical housing to provide a sensing unit which is ready for immediate installation by the original equipment manufacturer. In other words, "A CUSTOMER-SPECIFIC HYBRID ASSEMBLY." Special lenses and circuit techniques can be incorporated to tailor the optical path in order to optimize the sensor for each individual requirement. Among customer options available are signal-conditioning circuitry using either through-hole or surface mount printed circuit boards, digital or analog outputs, any type of electrical connector, either integrally mounted to the housing or on fly leads, and custom mechanical housings to fit any shape specified. In addition, fiber optic cables can be integrated right into the assembly, taking advantage of hot alignment to insure that maximum power is launched into the fiber.

Either transmissive or reflective sensing is available as needed to fit any application. Prototype turn-around is rapid and precise. Machined sample parts have been delivered in as little as three weeks from the initial customer contact. In addition to the in-house capabilities in optoelectronics components, the design team can draw from the entire line of Motorola Semiconductor products, and utilize the resources of the Corporate Research Labs to optimize product design. Outside the company, the Custom Opto Module Team has developed a stable core of suppliers to provide all of the other pieces necessary to produce application-specific assemblies.

Where Is Our Strength?

The customer-oriented design team consists not only of experts in electro-optics, but also includes engineers with expertise in printed circuit board assembly, mechanical packaging, reliability, production, environmental testing, and marketing. The Optoelectronics engineering group holds a commendable portfolio of 65 patents, more than half for breakthroughs in the design of Custom Modules. Unlike typical semiconductor manufacturers, the Custom Opto Modules Team specializes in packaging innovation.

The Modules Team's strength lies in CONCURRENT ENGINEERING. Starting early in the project, ideally before the design cycle is very far advanced, Motorola's engineers work closely with the customer's project engineers to provide a SENSING SOLUTION rather than just a component to fill a pre-defined socket. Including the customer as a participating member of the design team results in a more direct path to the final answer to his sensing problems and greatly enhances the probability of providing exactly the right solution. Success, shown through satisfied customers and continuing shipments, has been amply demonstrated not only in automotive

applications but in industrial and computer segment challenges as well.

Millions of custom modules, capable of meeting the most stringent reliability requirements, have been shipped to both automotive and industrial customers over the last four years. The return rate for quality issues on these units has been close to zero. Custom Modules has the honor of having received the prestigious Ford Q1 award from both the engineering and manufacturing operations.

Why Use Custom Modules?

Custom Modules can offer a significant advantage from a standpoint of overall system cost. While not intended to be competitive with a single component, the overall cost to the customer of the total application can be greatly reduced by having much of the additional circuit requirements and packaging included in a module. By purchasing a value-added component, the non-electronic OEM is freed of the necessity of having an electronic assembly area, or of having to contract the assembly in another facility. Inventory issues are simplified by having only one part type rather than stocking all of the individual components necessary to make up the module. Experience in module assembly and coordination of components allows Motorola to begin the learning curve for a more advanced point, resulting in still larger savings to the customer.

On the performance side, the optoelectronic circuitry can be optimized to give maximum sensitivity, and frequency response. Higher resolution and accuracy are possible, since all of the components and mechanical parts have been optimized by design to work together.

Applications

The list of potential applications is limited only by the imagination of the user. Motorola has successfully supplied Custom Modules to automotive, industrial, consumer and computer peripherals manufacturers. Some of the potential applications are listed as a reference. The list is by no means all-inclusive, and the ready availability of low cost sensing modules opens up new opportunities every day.

Automotive Applications

Automatic Wiper Control	Ambient Light Detector
Steering Rotational Sensor	Headlight Dimmer
Speedometer Sensor	Dash Backlight Control
Crank Angle Sensor	Air Conditioner Control
Remote Audio Link	Remote Controls
Door Lock Monitor	Ride Control
Load Leveling	

Industrial/Reprographic Applications

Paper Sensing	Automatic Parts Counting
Edge and End Detection	End-Of-Ribbon Detecting
Positioning	Bar Code Detection
Background Density Sensor	Motion and Direction
Weight and Stiffness	Detection
HVAC Control	Speed Detection
Automatic Light Control	Small Drop Detection

Is Motorola Really The Benchmark In Custom Opto?

As a result of years of experience in working with demanding customers to provide solutions where previously there had been no solution, Motorola has developed a solid understanding of the sensor market. The dedication of the team members and their "Can-Do" spirit, combined with a wide open charter to get the job done, have resulted in an outstanding track record of accomplishments in the Opto sensing field.

The Module is only as strong as its weakest component, and power degradation has been the nemesis of optoelectronic performance from the beginning. Motorola has spent two years in developing a world-class "Low-Deg" process to

manufacture its GaAs LEDs to insure the highest level of performance with the lowest possible degradation of power output over time and temperature. These LEDs make up the most basic building blocks of the Custom Modules.

Motorola is uniquely organized to develop and manufacture low cost hybrid assemblies, each tailored specifically to the individual customer's needs. The Quality and Reliability of Motorola's Custom Opto Assemblies are built in from the beginning. Each module is designed from the start for manufacturability, with consideration taken to insure that all of the processes will be compatible with Motorola's corporate edict of Six Sigma product to its customers. A strong commitment to concurrent engineering is normal operating procedure.

SOLUTIONS TO YOUR CUSTOM SENSING NEEDS!

Faint, illegible text at the top of the page, possibly bleed-through from the reverse side.

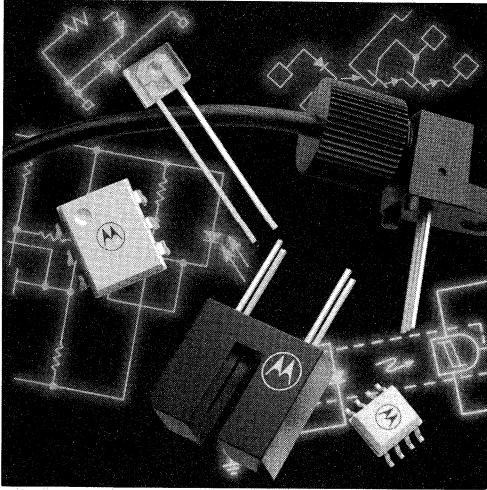

Section Two

Quality and Reliability

Optocoupler Reliability & Quality	2-2
Design Driven LED Degradation Model for Optoisolators	2-3
Reliability Testing Considerations for Optoelectronic Sensors	2-7
Dome Package Evaluation	2-10
Optocoupler Process Flow and QA Inspections	2-11
Opto Case 422/422A Package	2-13

Optocoupler Reliability & Quality

2

Reliability Considerations

Emitter Life

The area of optocoupler reliability that is of most concern to users is the life of the IRED (Infrared Emitting Diode). Anything which alters the carrier-recombination process (the light-emitting mechanism) will cause a decrease in coupling efficiency with time. There are several possible ways this can happen, depending upon the device and process design:

1. Propagation of initial crystal stress or damage through the device in the vicinity of the junction can cause an increase in non-radiative recombination, since carrier lifetimes are poor in such regions. Motorola now uses exclusively a Liquid Phase Epitaxial (LPE) process which allows a stress-free growth and minimizes the effect of substrate integrity, since the junction is formed some distance from the substrate.
2. Damage caused by assembly of the IRED chip into a package can also cause degradation, usually observable in less than a few hundred hours of operation. Motorola uses automatic die attach and wire attach equipment, so that operator control of pressure is eliminated. In addition, the application of a die passivation during assembly insures that the IRED chip is protected from external mechanical stress.
3. Impurities which exist in the chip as a result of process contamination can be detrimental if they are mobile in gallium arsenide. Forward current bias will energize these impurities and the current drift will draw them toward the junction where they can affect recombination to a greater degree. Proper process design and control of equipment is necessary to minimize this effect. Motorola continually audits its process to provide the necessary monitor on LED life characteristics.
4. Impurities external to the chip can be drawn into the device and affect recombination under certain conditions.

Detector Stability

While the detector has a lesser overall influence on the reliability of an optocoupler than the IRED (due to the difference between gallium arsenide and silicon characteristics), there still remain important considerations here as well. These primarily are measures of its ability to remain reliably "off" when the IRED is not energized, requiring that breakdown voltages and leakage be stable.

Efficient optically sensitive semiconductors place an extra burden on the manufacturer to produce stable devices. Large surface areas are needed to capture large amounts of light,

but also give higher junction leakage. Low doping concentrations are necessary for long carrier lifetimes, but also create more chance for surface inversion which leads to leakage instability. High electrical gains magnify currents due to captured photons but do the same to junction leakage currents.

Package Integrity

There are several packaging considerations which are unique to an optocoupler. It is necessary, of course, that light be efficiently coupled from input to output. As a result, most optocouplers have internal constructions that are radically different than other semiconductor devices and use materials that are dictated by that construction. Just as parametric stability of the IRED and detector chips used in an optocoupler is important, so also is it important that package parameters be stable. Areas of concern are:

1. **Isolation Voltage** — Together with the transmission of a signal from input to output, the ability of an optocoupler to isolate its input from high voltage at its output is probably its most important feature. Human safety and equipment protection are often critically dependent upon dielectric stability under severe field conditions. Motorola uses a dual molding scheme, whereby an opaque epoxy overmold surrounds an infrared transparent epoxy undermold. Both materials are very stable under repeated applications of high fields and the integrity of the interface between the two materials is assured due to the basic similarity of the compounds. Industry leading isolation voltage capability, both in terms of voltage level and stability, is the result. Motorola specifies all of its optocouplers at 7500 Vac peak isolation.
2. **Mechanical Integrity** — It is also important that the package be capable of withstanding vibration and temperature stresses that may be found in the field environment. Motorola's solid package construction and the use of repeatable automatic ball bond wire attach equipment provide this performance at rated conditions.
3. **Moisture Protection** — Relatively high humidity is characteristic of many field environments, although usually not on a continuous basis. Motorola's chip design minimizes the effect of moisture internal to the package, usually by covering the aluminum metallizations with protective passivations. The package materials typically provide stable isolation voltage after well over 1000 hours of continuous exposure to a high temperature, high humidity environment and will provide very long term service under intermittently humid conditions.

Design Driven LED Degradation Model for Optoisolators

Results from a matrix of temperature and current stress testing of optoisolator LEDs are presented. Extensive statistical analysis of this large data base is shown, along with the method used to define the shape of the LED degradation curves. A basic equation was developed based on the Arrhenius model for temperature dependent effects and the author's experience with the physics of LED degradation. Also shown are the results of multiple regression analysis of the plotted points and how they were used to resolve the constants associated with this equation. In addition, explanations are presented of unusual findings and their causes. This equation can be used by circuit designers to predict LED degradation for any time, operating current and ambient temperature (an industry first). A graph of percent degradation versus time is shown, and was derived by plugging into the equation typical use currents and temperatures. A further refinement is presented that describes degradation in terms of a "Six Sigma" distribution, giving the ability to encompass variations encountered during production.

Background

Light Emitting Diodes (LEDs) are devices which use PN junctions to convert electrical current to light. This emitted light can be of the visible or infrared wave length. In the case of the LEDs in Motorola's optocouplers, this light is in the infrared (~940 nm) wave length. The externally applied current injects minority carriers which recombine with majority carriers in such a way as to give off light (or photons). This process is called "radiative recombination."¹ Figure 1 depicts the overall construction of Motorola's 940 nm LED die.

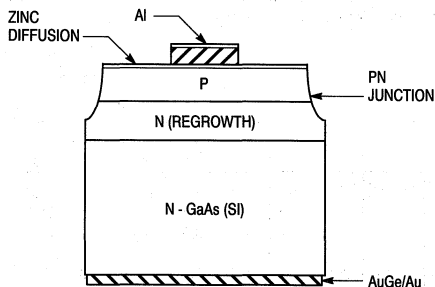

Figure 1. Amphoterically Doped LPE Grown Junction

The junction is an amphoterically doped liquid phase epitaxial (LPE) grown junction on a Gallium Arsenide (GaAs) substrate. The back side of the die uses AuGe metal to form an eutectic attach to the lead frame. A very thin Zn diffused layer is used to spread current across the junction. The top Al metal is used to provide ohmic contact for a wire bond connection.

LED Degradation

LED degradation occurs when the efficiency of radiative recombination of minority carriers is decreased with time.² At Motorola the following processing/assembly steps have been found to affect LED performance as it relates to LED degradation (Figure 2).

1. Wafer related defects
 - A. Zn diffusion defects
 - B. Substrate dislocations
 - C. Surface polishing
 - D. EPI defects
 - E. Doping concentration
 - F. Junction heating
 - G. Ohmic contact stress
2. Assembly related defects
 - A. Die attach stress
 - B. Wire bond damage
 - C. Molding stress

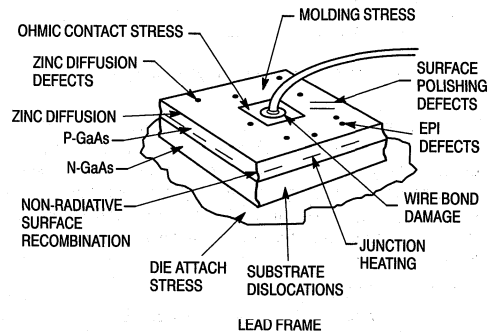

Figure 2. LED Degradation Sources

Approaches

In the past, a circuit designer needing information about LED degradation in optoisolators (couplers) would only receive curves that depicted LED degradation over time for a specific drive current, measurement current and ambient temperature. This forced the designer to assume a very worst case degradation and excluded the use of couplers in circuits requiring tighter limits on the amount of allowable degradation. No one in the Optoisolator industry supplied data about their LED performance to allow the designer to predict the amount of LED degradation for his specific application.

Solutions

Over the past three years Motorola's Optoelectronics Operation has invested significant resources to improve LED degradation performance. More than thirty experiments were designed and performed generating some 30 megabytes of computer data in an effort to identify and prove out the LED wafer processing improvements. These improvements include a number of critical wafer processing steps that required change and exact control.

2

Initial Room Temperature Testing

Transistor optocouplers (see Figure 3) samples were measured using the above improvements and placed on LED burn-in.

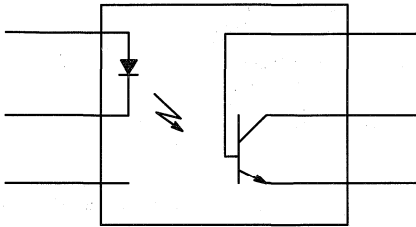

Figure 3. Transistor Optocoupler

The conditions were room temperature at a forward current (I_F) stress of 50 mA dc. The transistor was not biased. The ratio of the transistor collector current (I_C) to the I_F current is the measurement used to gauge LED light output. This ratio is known as Current Transfer Ratio (CTR). LED light output was measured at specified intervals during testing. The conditions for measurement were:

$$I_F = 10 \text{ mA}; V_{CE} = 10 \text{ V.}$$

Figure 4 is a graph of the average percentage degradation over 10,000 hours. The dotted lines represent the capabilities of the measurement system. As can be seen, little degradation occurred. Data generated from samples provided to one of our customers confirmed these results.

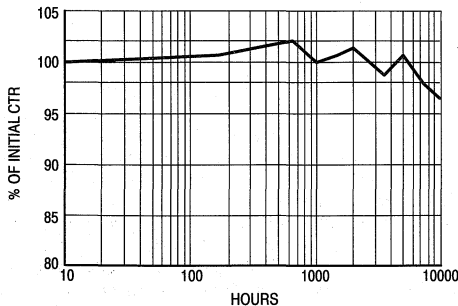

Figure 4. Plot of Average LED Degradation @ $I_F(\text{stress}) = 50 \text{ mA}; I_F(\text{meas}) = 10 \text{ mA @ } 25^\circ\text{C}$

Accelerated Testing

In an effort to provide customers with information that would help them predict CTR degradation at any current and ambient, a temperature and stress current matrix evaluation was designed (see Table 1).

		Ambient Stress Temperature		
		85°C	105°C	125°C
LED Stress Current	0.5 mA	Group A 30 Devices	Group B 30 Devices	Group C 30 Devices
	3 mA	Group D 30 Devices	Group E 30 Devices	Group F 30 Devices
	50 mA	Group G 30 Devices	Group H 30 Devices	Group I 30 Devices

Table 1

This testing led to results on a total of 270 devices with measurements taken at 6 times (0, 71, 168, 250, 500 and 1000 hours). The measurements were taken on I_B and I_C at 4 current levels (0.5, 3, 10 and 50 mA). This produced a total of or 12,960 data points.

The following (Table 2) is a summary of the results of the testing expressed in average percent degradation of I_C and I_B from 0 to 1000 hours. I_B is the transistor base photo current generated by the LED light output. I_C is the collector current of the phototransistor and is related to the LED light output multiplied by the h_{FE} of the transistor. Note that the 0.5 mA measurement results are not included. This was because the detector current generated at 0.5 mA LED drive current was very low (nA range). It was determined that measurement error was significant at this very low current.

		Ambient Stress Temperature							
		85°C	105°C	125°C					
LED Stress Current	0.5 mA	Measurement Current	I_C	I_B	I_C	I_B			
			3 mA	4.0	2.9	11.7	8.1	24.2	17.3
			10 mA	3.6	4.7	6.3	8.4	21.7	17.4
	50 mA	1.0	6.8	0.7	8.2	2.4	18.3		
	3 mA	3 mA	5.5	4.2	13.3	9.0	23.5	16.7	
		10 mA	4.9	4.8	7.6	9.3	21.0	16.9	
		50 mA	1.2	7.7	0.8	10.6	2.1	18.2	
	50 mA	3 mA	11.1	8.1	23.0	17.2	27.1	20.3	
		10 mA	8.0	8.1	17.2	15.5	21.6	19.1	
		50 mA	1.4	10.6	2.3	12.3	3.3	17.6	

Table 2

Analysis of Results

A review of the above results reveals an unusual response for I_C degradation for the 50 mA measurement current. The percent degradation is much less when compared to the

10 mA I_B measurement. This apparent improvement in CTR is actually a function of the phototransistor's h_{FE} changing. To explain, the following graph (Figure 5) represents the h_{FE} of the transistor versus drive current (I_B).

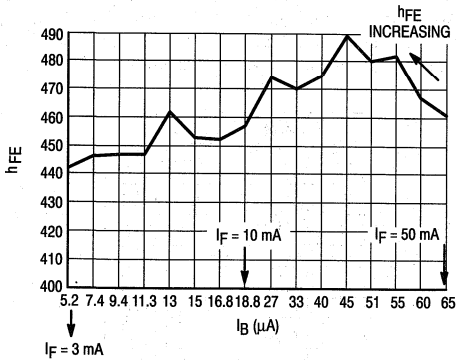

Figure 5. h_{FE} versus Photo Generated Current (I_B)

What this means is that as I_B decreases during stress testing (as would be the case with LED light output decreasing) in the area of 65 to 55 μA , the h_{FE} rises. Therefore as the LED degrades at high I_F currents (50 mA) the h_{FE} actually increases, compensating for the decrease in LED light output degradation. The overall result is that the CTR degradation appears to be less at the higher measurement currents.

This problem shows the need to express LED degradation more clearly. By using a term called Differential Quantum Efficiency (DQE) a truer picture of LED degradation can be obtained. DQE can be graphically pictured (see Figure 6).

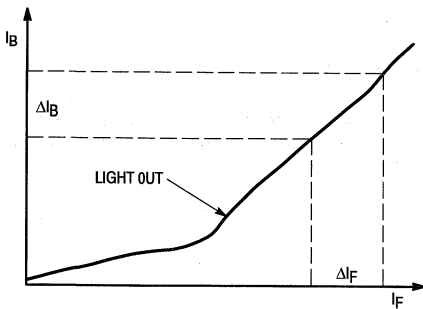

Figure 6. DQE is Expressed as ΔI_B Divided by ΔI_F

In the case of this evaluation, DQE was derived by measuring I_B at the I_F delta of 3 to 10 mA. A summary table of the average DQE degradation percent from 0 to 1000 hours is shown below (Table 3). The calculated junction temperatures in degrees K are in parenthesis.

Ambient Stress Temperature			
	85°C	105°C	125°C
0.5 mA	Group A 5.4 (358)	Group B 8.5 (378)	Group C 17.4 (398)
	Group D 5.0 (359)	Group E 9.4 (379)	Group F 17.0 (399)
3 mA	Group G 8.1 (371.5)	Group H 14.8 (391.5)	Group I 18.6 (411.1)
50 mA			

Table 3. Average DQE Degradation (%) 0 to 1000 Hours

A plot of these values on a graph (Figure 7) compares the DQE degradation at 1000 hours to LED junction temperature. The junction temperature was calculated based on a Theta J of 180°C/W. Note that the percent degradation appears to be affected only by overall junction temperature. That is, only the junction heating due to the surrounding ambient and the heating affects of LED current cause degradation, and not the affects due to current density (Group G - Group B).

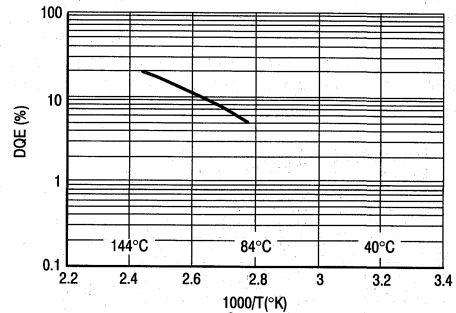

Figure 7. DQE Degradation (%)

A best fit straight line can be drawn through these points and its slope can be used to calculate the activation energy. A plot of the relative DQE versus time for all the groups are similar to B, E and H as shown in Figure 8.

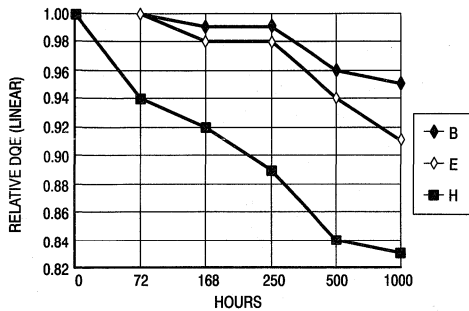

Figure 8. Relative DQE Degradation (%)

These curves can be fit to a polynomial of the kind that relates temperature to DQE degradation over time. This relationship can be expressed as:

$$\text{Relative DQE} = 1 + (1 + e^{(A - E_a/T_j)K}) \times \ln(1 + t^2 \times e^{(E_a/T_j)K - B}) \quad (1)$$

Where:

- A & B = Constant
- E_a = Activation Energy
- T_j = T_A + (V_F × I_F × Theta J) + 273
- K = Boltzmann's Constant (8.617 × 10⁻⁵ eV/°K)³
- t = Time under stress testing
- Theta J = 180°C/Watt

Conclusions

By plugging in applicable junction temperatures and I_F drive currents, a prediction of degradation at any time can be made. A few representative curves of temperature and drive current are shown in Figure 9. By using this relationship, LED drive currents can now be much more accurately chosen at circuit design and can assure long operating life.

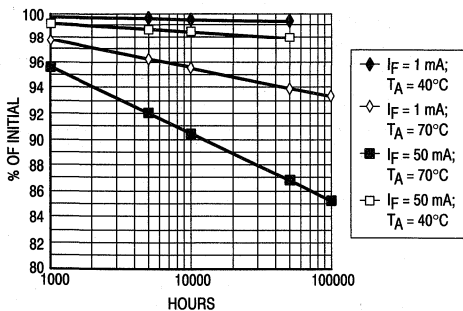

Figure 9. Average Degradation

A further refinement to the above expression was made to encompass the lot to lot variations that would be typically seen in a large volume production mode. This was accomplished by adjusting the constant "A" based on the Table 2 sample distributions. The six sigma points of each group in the sample were calculated and used to adjust their averages downward (X bar + 6 sigma). Replotting the curves in Figure 9 would look like those below in Figure 10. This predictability is made possible through the LED wafer processing improvements implemented, and the data analysis presented here.

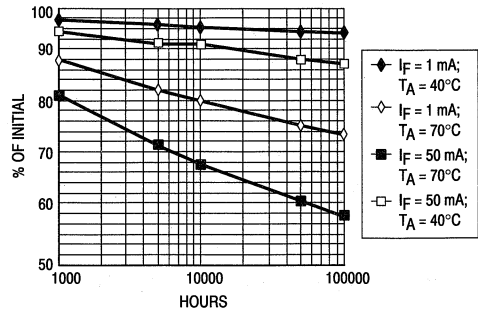

Figure 10. Six Sigma Degradation

References

- [1] Motorola Applications Note AN440, Motorola Optoelectronics Device Data Book, Q2/89 DL118, REV 3.
- [2] J.R. Biard, G.E. Pittman, and T.F. Leezer. "Degradation of Quantum Efficiency in Gallium Arsenide Light Emitters," Proceedings of International Symposium on GaAs, Sept. 1966.
- [3] Wayne Nelson, "Accelerated Testing," 1991, John Wiley and Sons.

Acknowledgements

The author wishes to thank Dr. Daniel L. Rode for his valuable assistance in the physical modeling of GaAs LED degradation.

Reliability Testing Considerations for Optoelectronic Sensors

Abstract

With the increasing use of optoelectronic devices in a wider variety of sensing applications that require longer life, a closer look at reliability testing is needed. Applications in the automotive arena (ride control and speed sensing), along with office equipment (copy machines and printers), require longer life under conditions with unique environmental stress for optoelectronic sensors. These applications are the result of using a combination of optoelectronic and mechanical solutions that present a challenge for reliability testing and assessment. In addition, applications using solutions such as motion and/or reflective sensing require careful consideration from a reliability assessment standpoint. The use of the clear epoxy plastics and cast resin components as inserts for custom molded housing has made the cycle time from idea inception to final product much shorter, but also presents limitations on the types and levels of stress testing that can be performed. This paper discusses a number of unique reliability considerations that the optoelectronic sensor presents.

Background

Optoelectronic sensors, typically composed of a light emitting diode (LED) and a photodetector are becoming more pervasive in many applications. These applications range from automotive and office equipment to home improvement products. Solutions to sensing problems vary from the standard motion sensing using slotted interrupters to clever reflective techniques. Packaging technology has been changing as often as the applications require. Plastic housings with clear plastic inserts made of epoxy that are molded or cast have the significant advantage of low cost and faster development times (see Figure 1).

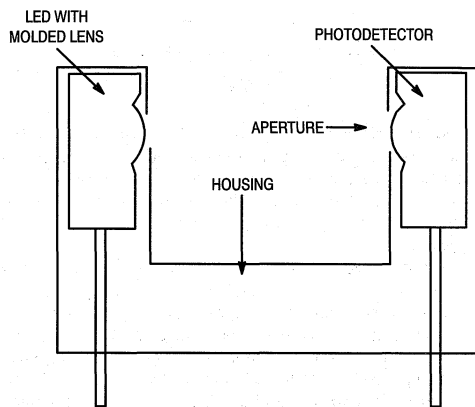

Figure 1. Typical Slotted Interrupter

Metal can packages have significant advantages in applications where harsh environments, especially high humidity are encountered. This paper will discuss the reliability test issues mostly related to the plastic inserts and their long term effect on the performance of the optoelectronic sensor.

Reliability Tests LED Stress Testing

One of the key reliability indices for any optoelectronic device is the LED optical power output degradation. LEDs are devices which use PN junctions to convert electrical current into light (known as radiative recombination). This light can be of the visible or infrared (~940 nm) wavelength. Degradation is generally described as a reduction in the efficiency of radiative recombination of minority carriers over time. Figure 2 details some possible sources of LED degradation from a processing and assembly standpoint.

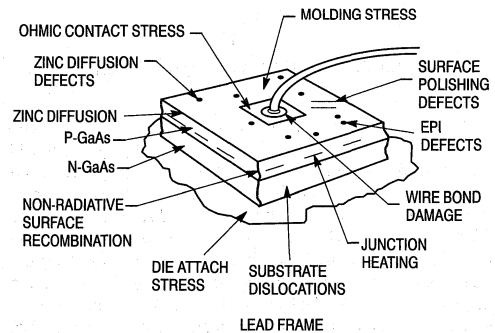

Figure 2. LED Degradation Sources

Circuit designers obtain a very significant advantage if a predictable amount of LED degradation can be calculated, given a specific operating current and ambient temperature. The following expression was developed for Motorola's infrared LEDs:

$$\% \text{ Deg} = 100 \times (1 + (1 + e^{(A - E_a/T_j)K}) \times \ln(1 + t_2 \times e^{(E_a/T_j)K - B}))) \quad [1]$$

Where:

- A and B = Constants
- E_a = Activation Energy
- T_J = T_A + (V_F × I_F × Theta J) + 273
- K = Boltzmann's Constant (8.617 × 10⁻⁵ eV/°K) [2]
- t = Time under stress testing
- Theta J = 180°C/Watt

This expression includes considerations for a six sigma process distribution which makes it particularly useful by encompassing lot to lot variations.

Temperature Cycling

Many of the LEDs and photodetectors that are used in optosensor assemblies are molded in epoxy plastic (see Figure 3).

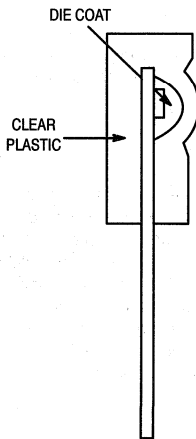

Figure 3. Case 422A Clear Epoxy Package

These plastic mold compounds are non-filled resin epoxies that allow them to produce the clear packaging needed to transmit / receive light. This compound has a glass transition temperature of around 125°C and has a much larger coefficient of thermal expansion (CTE) than the glass-filled black epoxy used for most semiconductors.

Another factor that affects temperature cycle reliability is the need for a protective die coat over the LED die. This is needed to cushion the GaAs die from the mechanical pressure of the epoxy mold compound as it shrinks and expands. Mechanical stress on the LED causes micro fractures that lead to the so-called "dark line defect" and the resulting decrease in power out. This decrease in light emission is believed to be attributed to the formation of "non-radiative recombination sites." It is theorized that when minority carriers recombine with majority carriers in these sites, recombination occurs but no photon is emitted. The effects of the mechanical stress (i.e. non-radiative recombination sites) are not manifested until a forward stress current is applied for a period of time, although large decreases in light out become apparent in a short period of time (<72 hours). The addition of the silicon die coat cushions the LED, but introduces the possible problem of broken wire bonds due to the large mismatch in CTE between the die coat (300 PPM/°C), the epoxy (65 PPM/°C)[3] and the copper lead frame (16.4 PPM/°C). Although the photodetector does not require the die coat (silicon die), the mismatch between the epoxy and the copper lead frame still needs to be evaluated for reliability through temperature cycling. The typical temperature cycling conditions are -40°C to +100°C, air to air, 15 minutes at each extreme with < 15 seconds transfer time.

The use of the cast resin packaging for LEDs and detectors presents a similar problem, but with the added problem of even

larger CTE mismatch. Because of this, most of these packages are restricted to temperature extremes of -25°C to +70°C. With an epoxy package, thermal shock (liquid to liquid) can be performed but the cast resin package will literally shatter if subjected to these rapid changes in temperature. Typically, the cast resin devices are molded into the panel mount package configuration such as the T1-3/4 and T1 (see Figure 4).

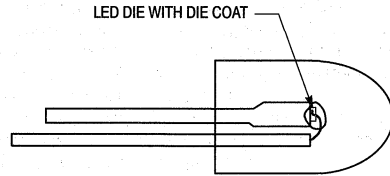

Figure 4. Panel Mount LED

Moisture Testing

As mentioned previously, the clear epoxy mold compound has a large CTE. This factor, along with addition of moisture, causes problems with lead-to-package sealing. If this lead-to-package interface is fractured from excessive expansion due to excessive heat, then moisture can easily travel up the lead and onto the die surface. As mentioned earlier, the glass transition temperature for the clear epoxy is approximately 125°C. This limit precludes the use of autoclave (121°C, 15 PSIG) as an accelerated test. The results in Table 1 testify to this limit.

Tests	Conditions	Sample Size	Failures
Autoclave	$T_A = 121^\circ\text{C};$		
	$\text{RH} = 100\%$		
	$\text{PSIG} = 15$		
	$t = 8 \text{ Hours}$	49	0
	$t = 16 \text{ Hours}$	49	6
	$t = 24 \text{ Hours}$	49	17

(Results of Case 422A Autoclave testing) [4]

Table 1

These results provide proof that this type of packaging is not really capable of withstanding wave solder followed by an aggressive wash cycle. Most manufactures are resigned to using hand soldering and mild cleanups. The cast resin devices, of course, cannot withstand the high temperature of autoclave.

The use of biased humidity ($T_A = 85^\circ\text{C}; \text{RH} = 85\%$) is generally a much more useful test in detecting marginal designs and poor performing mold compounds, along with inconsistent assembly processes. In the case of phototransistors, the current must be monitored and controlled while turning up the bias voltage. This is due to ambient light entering the humidity chamber. The use of current limiting resistors is strongly recommended. Once the chamber is closed, the bias current will generally be close to the dark current limit value. Of course, opening the chamber to remove

other samples during testing must be taken into consideration and monitored accordingly.

Solder Testing

There are two types of solder testing that should be used to evaluate the optosensors in plastic packages. Solder heat testing (260°C for 10 seconds) is very effective in identifying poorly performing mold compounds and lead frame designs. Typical failures noted are lifted wire bonds and, in the case of epoxy die attach, a lifted die. In addition, flux may wick up the lead frame package seal area if the mold compound is not adequately attached. Solderability testing (260°C with 90% coverage) will not only identify plating problems, but will also highlight any problems with cleaning agents that could harm the plastic housings for slotted interrupters. Many of these housings are polysulfone and can be damaged by Freon TMC and alcohol. This is also the case when using similar solvents during marking permanency testing. The polyester-type housings are generally much less susceptible to these solvents.

Dust Testing

This test is a very good method of assessing an optical sensor that is to be used in an environment that is susceptible to dust accumulation, particularly on the lens or in the aperture slot of the slotted interrupters. This is valid in automotive and some office equipment applications. Typically, this test is

performed by placing the sensors in a chamber of a specified size with a specified amount of dust (Arizona type) and pulsing the chamber with bursts of compressed air for about 5 hours. Measuring optical coupling of the LED to detector initially, and at the end of testing will identify designs with inadequate coupling and/or devices with poor optical alignment.

Summarizing Results

Detailed analysis of testing results can be of significant importance. Table 2 is an example of a method that can be used to statistically characterize optosensor testing results. Note that percentiles are given instead of average and sigma. This is to provide a more realistic picture of the distribution, since most devices undergo electrical screening which results in lots that are skewed through parameter selection. Close inspection of the delta shifts reveals the direction of shift and changes in the shape of the distribution.

Conclusions

Optical sensors offer a wide variety of solutions to problems of motion sensing and other optical detecting. The use of cost effective plastic sensors and housings brings with them some significant reliability testing issues that have been addressed in this paper. Utilizing these tests and their results will provide help in choosing appropriate designs, materials and assembly processes that will give rise to a more reliable product.

Parameters	Device Type		10 Percent	Median	90 Percent	Actual Maximum	Maximum Specification Limit
	Specification Limit	Actual Minimum					
I_R: V_R = 6 V							
PRE	NONE	0.001 nA	0.003 nA	0.026 nA	0.081 nA	14.35 nA	100 μA
POST	NONE	0.001 nA	0.002 nA	0.017 nA	0.054 nA	7.664 nA	100 μA
Delta Percent	NONE	0.0%	0.0%	0.0%	0.0%	0.0%	NONE
V_F: I_F = 50 mA							
PRE	NONE	1.361 V	1.375 V	1.387 V	1.4 V	1.408 V	1.8 V
POST	NONE	1.371 V	1.376 V	1.429 V	1.579 V	1.747 V	1.8 V
Delta Percent	NONE	0.7%	0.1%	3.0%	12.8%	24.1%	NONE
P_O: I_F = 50 mA							
PRE	2.0 mW	2.059 mW	2.113 mW	2.172 mW	2.232 mW	2.359 mW	NONE
POST	2.0 mW	2.315 mW	2.374 mW	2.489 mW	2.575 mW	2.631 mW	NONE
Delta Percent	NONE	12.4%	12.4%	14.6%	15.4%	11.5%	NONE

Table 2. H3TRB Test Summary (Example of data summary) [5]

References

[1] John Keller, "Design Driven LED Degradation Model for Optoisolators" Proceedings of 42nd Electronic Components and Technology Conference, May 1992.

[2] Wayne Nelson, "Accelerated Testing," 1991, John Wiley and Sons.

[3] Motorola Reliability Report, April 1991.

[4] Hysol Information Bulletin E7-620A.

[5] Motorola Reliability Report, September 1991.

Optocoupler Dome Package

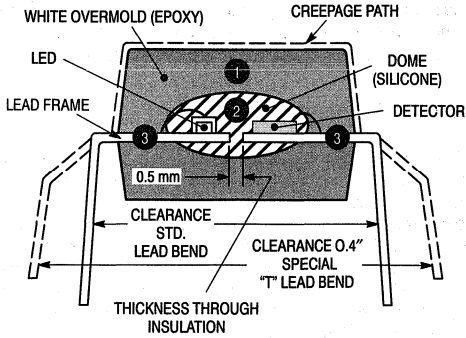

The DOME package is a manufacturing/quality improvement in that it represents a significant reduction in the complexity of the assembly steps. This is consistent with Motorola's goal of continual quality improvement by reduction in process variations (in this case through assembly simplification).

The following reliability testing summary confirms the quality of design and material selection.

Dome Package Evaluation

Package: 6-Pin DIP, Case 730A-04 (WHITE)

Parameters Monitored

Parameter	Conditions	Limits			
		Initial		End Points	
		Min	Max	Min	Max
I_R	$V_R = 3\text{ V}$		100 μA		100 μA
V_F	$I_F = 10\text{ mA}$		1.5 V		1.5 V
I_{CEO}	$V_{CE} = 10\text{ V}$		50 nA		50 nA
I_{CBO}	$V_{CB} = 10\text{ V}$		20 nA		20 nA
$V_{(BR)CEO}$	$I_C = 1\text{ mA}$	30 V		30 V	
$V_{(BR)CBO}$	$I_C = 100\ \mu\text{A}$	70 V		70 V	
$V_{(BR)ECO}$	$I_E = 100\ \mu\text{A}$	7 V		7 V	
I_C	$V_{CE} = 120\text{ V}$	2 mA		2 mA	
$V_{CE(sat)}$	$I_F = 10\text{ mA}$ $I_C = 2\text{ mA}$		0.5 V		0.5 V
V_{ISO}	$I_F = 50\text{ mA}$ $f = 60\text{ Hz } t = 1\text{ Sec.}$	5.35 k		—	

Life and Environmental Testing Results

Test	Conditions	Sample Size	Rejects	
			Limit	Catastrophic
IREDD Burn-In	$I_F = 50\text{ mA } t = 1000\text{ Hrs.}$	100	0	0
H ³ TRB	$T_A = 85^\circ\text{C RH} = 85\%$	71	0	0
HTRB	$V_{CB} = 50\text{ V, } t = 1000\text{ Hrs.}$	80	0	0
Intermittent Operating Life	$T_A = 100^\circ\text{C } V_{CB} = 50\text{ V}$ $t = 1000\text{ Hrs.}$	100	0	0
High Temperature Storage	$I_F = 50\text{ mA } I_C = 10\text{ mA}$ $V_{CE} = 10\text{ V } T_{on} = T_{off} = 1\text{ Min}$ $t = 1000\text{ Hrs.}$	100	0	0
Temperature Cycle	$T_A = 125^\circ\text{C } t = 1000\text{ Hrs.}$ $-40^\circ\text{C to } +125^\circ\text{C}$	99	0	0
Thermal Shock	Air-To-Air 15 Min at Extremes 1200 Cycles	58	0	0
Resistance to Solder Heat	Liquid-To-Liquid $0^\circ\text{C to } +100^\circ\text{C}$ 500 Cycles	100	0	0
Lead Pull	MIL-Std-750, Method 2031 260°C for 10 sec Followed by V_{ISO}	50	0	0
	MIL-Std-750, Method 2036 Cond A, 2 Lbs. 1 Min	5	0	0

Optocoupler Process Flow and QA Inspections (Dome Package)

- 1** PRE PROBE INSPECTION: A sampled microscopic inspection of class probed wafers for die related defects on the detector and emitter.
- 2** POST PROBE INSPECTION: Each lot of wafers is sampled and inspected microscopically and electrically to insure quality before shipping to the die cage. This includes both detector and emitter.
- 3** POST SAW INSPECTION: A sample of die is monitored by microscopic inspection for correct saw cut, and checks for cracks, chips, foreign material and missing metal are made. This includes both the detector and emitter.
- 4** DIE BOND INSPECTION: This microscopic inspection checks both die for die placement and orientation, cracks, chips and die attachment. In addition, a random sample of both bonded die are pushed off and the percent of remaining material evaluated.
- 5** WIRE BOND INSPECTION: Wire bonds are checked microscopically for placement, bond formation, damaged wire, lifted bonds and missing wire. In addition, a random sample of wire from the emitter and detector are subjected to a destructive wire pull test.
- 6** QA INTERNAL VISUAL GATE: This is a sampled QA gate to microscopically inspect for all of the defects described in numbers 4 and 5 above. All lots rejected are 100% rescreened before resubmitting.
- 7** QA VISUAL GATE: This is a sampled gate for the quality and dimensions of the dome coating operation.
- 8** MOLD INSPECTION: This is monitor inspection of a sample of molded units for defects such as voids, incomplete fills etc.
- 9** LEAD TRIM AND FORM INSPECTION: The final trimmed and formed units are monitored through a visual inspection.
- 10** QA VISO GATE: This is a sampled electrical high voltage test of the capabilities of the device and assures the 100% Viso testing performed just prior is without error.
- 11** QA FINAL VISUAL INSPECTION: This is a final external microscopic inspection for physical defects or damage, plating defects and lead configuration.
- 12** WEEKLY LED BURN-IN AND TEMPERATURE CYCLING AUDIT: Current transfer ratio (CTR) is measured on a sample prior to and after the application of 72 hours of a high forward LED stress current and the percentage change is calculated. Also a sample of completed units is subjected to 300 cycles of air to air temperature cycling. This information provides trend data which is fed back to direct assembly/processing improvements.
- 13** QA VISUAL/MECHANICAL AND ELECTRICAL GATE: A random sample from each final test lot is electrically tested to documented limits. In addition, marking and mechanical defects are gated.
- 14** OUTGOING FINAL INSPECTION: Outgoing lots are sample inspected for correct packing, part type, part count and documentation requirements.

Wafer Processing

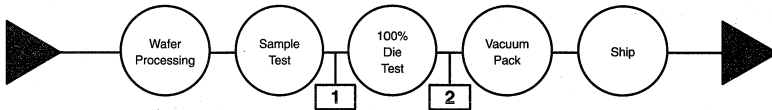

Coupler Assembly, Test and Mark

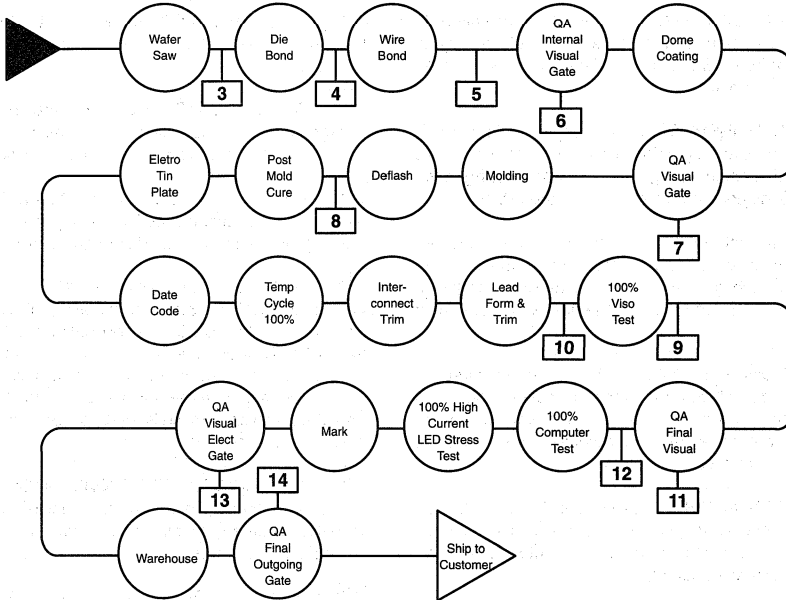

OPTO Case 422/422A Package

Side-Looking Plastic Discrete Devices

The Case 422/422A package is a manufacturing/quality improvement over other plastic side-looking products due to its use of highly automated assembly processes. Superior die placement yields maximum optical performance. A custom

designed optical grade mold with a state of the art mold process controller guarantees the finest quality and best reliability. The following life and environmental testing conditions are specified.

Life and Environmental Testing

Test	Conditions	Sample Size	Rejects	
			Limit	Catastrophic
Solder Heat	260°C for 10 sec	45	0	0
Solderability	Includes 8 hrs Steam Aging	10	0	0
Temperature Cycle	-40°C to 100°C, 15 min dwell, immediate transfer. 1000 cycles	50	0	0
Thermal Shock	Liquid to Liquid 0°C to 100°C, 1 min dwell, <15 sec transfer. 500 cycles	50	0	0
High Humidity, High Temperature, Reverse Bias (H ³ TRB)	T _A = 60°C, RH = 90% V _{CE} = 100% Rated 1000 hours	50	0	0
High Temperature Storage (HTS)	T _A = 100°C 1000 hours	50	0	0
LED Burn-in	I _F = 50 mA T _A = 25°C 1000 hours	50	0	0

Section Three

3

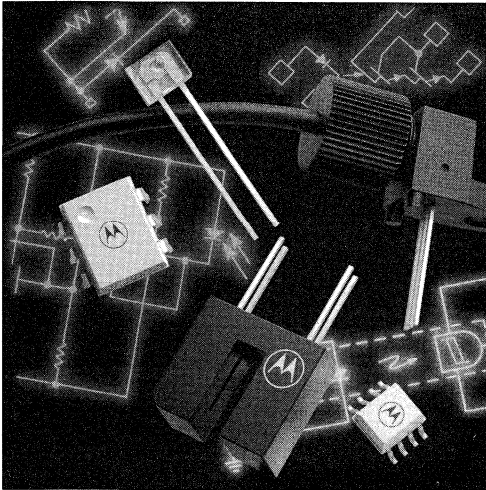

Motorola's families of optoelectronic components encompass red and infrared GaAs emitters and silicon detectors that are well matched for a variety of applications.

Optoisolators

Motorola's "Global" 6-Pin Dual In-line Package (DIP) devices use infrared emitting diodes that are optically coupled to a wide selection of output (Transistor, Darlington, Triac, and Schmitt trigger) silicon detectors. These devices are guaranteed to provide at least 7500 volts of isolation between the input and output and are 100% VISO tested. The entire line of Motorola 6-Pin DIP packages are recognized by all major safety regulatory agencies including UL and VDE. This extensive line of regulatory approvals attest to their suitability for use under the most stringent conditions. Motorola also offers a line of SOIC-8 small outline, surface mount devices that are UL approved and ideally suited for high density applications.

Emitters and Detectors

Motorola emitters (LEDs) are manufactured to operate at wavelengths of 660, 850 or 940 nanometers (nm).

The 940 nm emitters are least expensive. They are well suited for applications where close proximity to the detector tolerates a moderate mismatch in spectral response in exchange for lower cost.

The 850 nm emitters have peak emission which almost exactly matches that of silicon detectors. These emitters are widely used where efficiency and high speeds are of primary importance.

The 660 nm are visible and well matched to the characteristics of low-cost plastic fiber and find wide use in fiber optics communications.

Coupled with a line of silicon photodetectors with outputs tailored for specific applications (diodes, transistors, Darlington, triacs and Schmitt triggers), Motorola's product line offers the engineer a choice of components that can result in optimum system design.

Fiber Optics

Low cost components offer 10 MHz bandwidth for short distance communications. High performance emitter detector components provide transmission up to several kilometers with bandwidths in excess of 100 MHz.

Optointerrupters

Infrared LEDs facing photodetectors in a wide range of slotted packages permit custom design of systems to virtually any physical requirement. A wide selection of outputs (transistor, Darlington, logic, etc.) offers an excellent match for a variety of applications.

Chips

A number of LED and detector functions are available in chip form for hybrid system designs.

Selector Guide

Optoisolators	3-2
6-Pin Dual In-line Package	3-2
6-Pin Surface Mount	3-6
Small Outline — Surface Mount	3-9
POWER OPTO Isolators	3-10
Emitters/Detectors	3-11
Optointerrupters	3-12
Fiber Optic Components	3-13
Optoelectronic Chips	3-16

Optoisolators

6-Pin Dual In-line Package

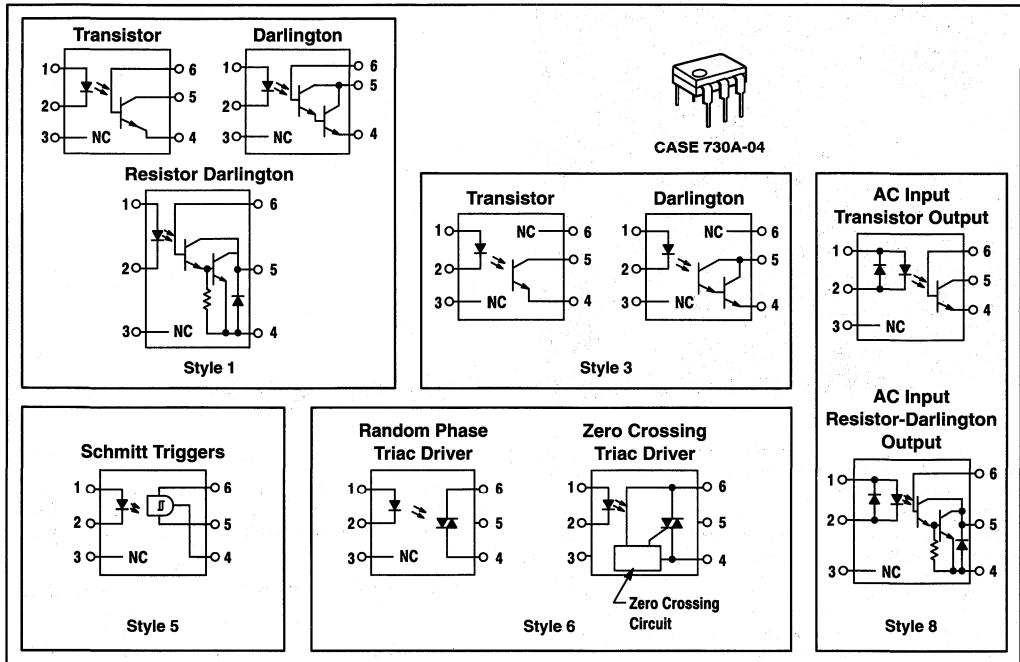

An optoisolator consists of a gallium arsenide infrared emitting diode, IRED, optically coupled to a monolithic silicon photodetector in a wide array of standard devices and encourages the use of special designs and selections for special applications. All Motorola optoisolators have V_{ISO} rating of 7500 Vac(pk), exceeding all other industry standard ratings.

Motorola offers global regulatory approvals, including UL, NEMKO, BABT, SETI, SEMKO, DEMKO and CSA. VDE(1) approved per standard 0884/8.87, with additional approvals to DIN IEC950 and IEC380/VDE 0806, IEC435/VDE 0805, IEC65/VDE 0860, VDE 110b, also covering all other standards with equal or less stringent requirements, including IEC204/VDE 0113, VDE 0160, VDE 0832, VDE 0833.

(1) VDE 0884/8.87 testing is an option; the suffix "V" must be added to the standard part number (see page 14-2).



CASE
730A-04



F or S
(F) CASE 730F-04
Surface-mountable
gull-wing low-profile option
(S) CASE 730C-04
Surface-mountable
gull-wing option



T
(T) CASE 730D-05
Wide-spaced (0.400")
lead form option

Optoisolator Lead Form Options

All Motorola 6-pin, dual in-line optoisolators are available in either a surface-mountable, gull-wing lead form or a wide-spaced 0.400" lead form, which is used to satisfy 8 mm pc board spacing requirements.

- Attach "F" to any Motorola 6-pin, dual in-line part number for low-profile, surface-mountable, gull-wing lead form.
- Attach "S" to any Motorola 6-pin, dual inline part number for surface-mountable, gull-wing lead form.
- Attach "T" to any Motorola 6-pin, dual in-line part number for wide-spaced 0.400" lead form.

Optoisolators
6-Pin Dual In-line Package (continued)



Table 1. Transistor Output
Pinout: 1-Anode, 2-Cathode, 3-N.C., 4-Emitter, 5-Collector, 6-Base (Style 1)

CASE 730A-04

Device	Current Transfer Ratio (CTR)			V _{CE(sat)}			t _r /t _f or t _{on} [*] /t _{off} [*] Typ					V _{(BR)CEO}	V _F	
	%	I _F	V _{CE}	Volts	I _F	I _C	μs	I _C	V _{CC}	R _L	I _F	Volts	Volts	I _F
	Min	@	Volts	Max	@	mA	@	mA	Volts	Ω	mA	Min	Max	@
TIL112	2	10	5	0.5	50	2	2/2	2	10	100		20	1.5	10
TIL111	8	16	0.4	0.4	16	2	5/5	2	10	100		30	1.4	16
4N27	10	10	10	0.5	50	2	1.2/1.3	10	10	100		30	1.5	10
4N28	10	10	10	0.5	50	2	1.2/1.3	10	10	100		30	1.5	10
4N38,A	10	10	10	1	20	4	1.6/2.2	10	10	100		80	1.5	10
H11A4	10	10	10	0.4	10	0.5	1.2/1.3	2	10	100		30	1.5	10
4N25,A	20	10	10	0.5	50	2	1.2/1.3	10	10	100		30	1.5	10
4N26	20	10	10	0.5	50	2	1.2/1.3	10	10	100		30	1.5	10
H11A2	20	10	10	0.4	10	0.5	1.2/1.3	2	10	100		30	1.5	10
H11A3	20	10	10	0.4	10	0.5	1.2/1.3	2	10	100		30	1.5	10
H11A520	20	10	10	0.4	20	2	5*/5*	2	10	100		30	1.5	10
H11AV3	20	10	10	0.4	20	2	5*/4*	2	10	100		70	1.5	10
MCT2	20	10	10	0.4	16	2	1.2/1.3	5	2k	15	30	1.5	20	
MCT2E	20	10	10	0.4	16	2	1.2/1.3	2	10	100		30	1.5	20
TIL116	20	10	10	0.4	15	2.2	5/5	2	10	100		30	1.5	60
H11A5	30	10	10	0.4	10	0.5	1.2/1.3	2	10	100		30	1.7	10
CNX35	40-160	10	0.4	0.4	10	2	3/3*	2	5	100		30	1.5	10
CNX36	80-200	10	0.4	0.4	10	4	8/6*	2	5	100		30	1.5	10
CNX83	40	10	0.4	0.4	10	4	3/3"	2	5	100		50	1.5	10
CNY17-1	40-80	10	5	0.4	10	2.5	1.6/2.3"	5	75	10	70	1.65	60	
MCT271	45-90	10	10	0.4	16	2	4.9*/4.5*	2	5	100		30	1.5	20
MOC8100	50	1	5	0.5	1	0.1	3.8/5.6	2	10	100		30	1.4	1
H11A1	50	10	10	0.4	10	0.5	1.2/1.3	2	10	100		30	1.5	10
H11A550	50	10	10	0.4	20	2	5*/5*	2	10	100		30	1.5	10
H11AV2	50	10	10	0.4	20	2	5*/4*	2	10	100		70	1.5	10
TIL117	50	10	10	0.4	10	0.5	5/5	2	10	100		30	1.4	16
TIL126	50	10	10	0.4	10	1	2/2	2	10	100		30	1.4	10
SL5501	45-250	10	0.4	0.4	20	2	20*/50*	5	1k	16	30	1.3	20	
CNY17-2	63-125	10	5	0.4	10	2.5	1.6/2.3	5	75	10	70	1.65	60	
MCT275	70-210	10	10	0.4	16	2	4.5*/3.5*	2	5	100		80	1.5	20
MCT272	75-150	10	10	0.4	16	2	6*/5.5*	2	5	100		30	1.5	20
4N35	100	10	10	0.3	10	0.5	3.2/4.7	2	10	100		30	1.5	10
4N36	100	10	10	0.3	10	0.5	3.2/4.7	2	10	100		30	1.5	10
4N37	100	10	10	0.3	10	0.5	3.2/4.7	2	10	100		30	1.5	10
H11A5100	100	10	10	0.4	20	2	5*/5*	2	10	100		30	1.5	10
CNY17-3	100-200	10	5	0.4	10	2.5	1.6/2.3	5	75	10	70	1.65	60	
SL5500	50-300	10	0.4	0.4	50	10	20*/50*	5	1k	16	30	1.3	20	
H11AV1	100-300	10	10	0.4	20	2	5*/4*	2	10	100		70	1.5	10
MCT273	125-250	10	10	0.4	16	2	7.6*/6.6*	2	5	100		30	1.5	20
MCT274	225-400	10	10	0.4	16	2	9.1*/7.9*	2	5	100		30	1.5	20

Table 2. Transistor Output with No Base Connection
Pinout: 1-Anode, 2-Cathode, 3-N.C., 4-Emitter, 5-Collector, 6-Base (Style 3)

MOC8101	50-80	10	10	0.4	5	0.5	3.2/4.7	2	10	100		30	1.5	10
MOC8102	73-117	10	10	0.4	5	0.5	3.2/4.7	2	10	100		30	1.5	10
MOC8103	108-173	10	10	0.4	5	0.5	3.2/4.7	2	10	100		30	1.5	10
MOC8104	160-256	10	10	0.4	5	0.5	3.2/4.7	2	10	100		30	1.5	10
MOC8111	20	10	10	0.4	10	0.5	3.2/4.7	2	10	100		30	1.5	10
CNX82	40	10	0.4	0.4	10	4	3/3*	2	5	100		50	1.5	10
MOC8112	50	10	10	0.4	10	0.5	3.2/4.7	2	10	100		30	1.5	10
MOC8113	100	10	10	0.4	10	0.5	3.2/4.7	2	10	100		30	1.5	10

Devices listed in bold, italic are Motorola preferred devices.

3

Optoisolators

6-Pin Dual In-line Package (continued)



CASE 730A-04

Table 3. AC Input – Transistor Output

Pinout: 1-LED 1 Anode/LED 2 Cathode, 2-LED 1 Cathode/LED 2 Anode, 3-N.C., 4-Emitter, 5-Collector, 6-Base (Style 8)

Device	Current Transfer Ratio (CTR)			V _{CE(sat)}			t _r /t _f or t _{on} */t _{off} * Typ					V _{(BR)CEO}	V _F	
	% Min	@ I _F mA	V _{CE} Volts	Volts Max	@ I _F mA	I _C mA	μs @ I _C mA	V _{CC} Volts	R _L Ω	I _F mA	Volts Min	Volts Max	@ I _F mA	
<i>H11AA1</i>	20	±10	10	0.4	±10	0.5					30	1.5	±10	
<i>H11AA2</i>	10	±10	10	0.4	±10	0.5					30	1.8	±10	
<i>H11AA3</i>	50	±10	10	0.4	±10	0.5					30	1.5	±10	
<i>H11AA4</i>	100	±10	10	0.4	±10	0.5					30	1.5	±10	

Table 4. AC Input – Resistor Darlington Output

Pinout: 1-LED 1 Anode/LED 2 Cathode, 2-LED 1 Cathode/LED 2 Anode, 3-N.C., 4-Emitter, 5-Collector, 6-Base (Style 8)

MOC8060	1000	±10	10	2	±10	100					50	1.5	±10
---------	------	-----	----	---	-----	-----	--	--	--	--	----	-----	-----

Table 5. Darlington Output

Pinout: 1-Anode, 2-Cathode, 3-N.C., 4-Emitter, 5-Collector, 6-Base (Style 1)

4N31	50	10	10	1.2	8	2	0.6*/17*	50	10		200	30	1.5	10
4N29,A	100	10	10	1	8	2	0.6*/17*	50	10		200	30	1.5	10
4N30	100	10	10	1	8	2	0.6*/17*	50	10		200	30	1.5	10
H11B255	100	10	5	1	50	50	125*/100*	10	10	100		55	1.5	20
MCA230	100	10	5	1	50	50	10/35		10	100	50	30	1.5	20
MCA255	100	10	5	1	50	50	10/35		10	100	50	55	1.5	20
H11B2	200	1	5	1	1	1	1/2	10	10	100		25	1.5	10
MCA231	200	1	1	1.2	10	50	80	10	10	100		30	1.5	20
TIL113	300	10	1.25	1	50	125	300	125	15	100		30	1.5	10
4N32,A	500	10	10	1	8	2	0.6*/45*	50	10		200	30	1.5	10
4N33	500	10	10	1	8	2	0.6*/45*	50	10		200	30	1.5	10
H11B1	500	1	5	1	1	1	1/2	10	10	100		25	1.5	10
MOC8080	500	10	5	1	1	1	1/2		10	100	5	55	1.5	10

Table 6. Darlington Output with No Base Connection

Pinout: 1-Anode, 2-Cathode, 3-N.C., 4-Emitter, 5-Collector, 6-N.C. (Style 3)

MOC119	300	10	2	1	10	10	1/2	2.5	10	100		30	1.5	10
TIL119	300	10	2	1	10	10	300	2.5	10	100		30	1.5	10
MOC8030	300	10	1.5				1/2		50	100	10	80	2	10
MOC8020	500	10	5				1/2		50	100	10	50	2	10
MOC8050	500	10	1.5				1/2		50	100	10	80	2	10
MOC8021	1000	10	5				1/2		50	100	10	50	2	10

Table 7. Resistor Darlington Output

Pinout: 1-Anode, 2-Cathode, 3-N.C., 4-Emitter, 5-Collector, 6-Base (Style 1)

<i>H11G1</i>	1000	10	1	1	1	1	5*/100*		5	100	10	100	1.5	10
<i>H11G2</i>	1000	10	1	1	1	1	5*/100*		5	100	10	80	1.5	10
<i>H11G3</i>	200	1	5	1.2	50	20	5*/100*		5	100	10	55	1.5	10

Devices listed in bold, italic are Motorola preferred devices.

Optoisolators
6-Pin Dual In-line Package (continued)



CASE 730A-04

Table 8. High Voltage Transistor Output
Pinout: 1-Anode, 2-Cathode, 3-N.C., 4-Emitter, 5-Collector, 6-Base (Style 1)

Device	Current Transfer Ratio (CTR)			V _{CE(sat)}			t _r /t _f or t _{on} */t _{off} * Typ					V _{(BR)CEO}	V _F	
	% Min	@ I _F mA	V _{CE} Volts	Volts Max	@ I _F mA	I _C mA	μs @ I _C mA	V _{CC} Volts	R _L Ω	I _F mA	Volts Min	Volts Max	@ I _F mA	
MOC8204	20	10	10	0.4	10	0.5	5*/5*	2	10	100	400	1.5	10	
H11D1	20	10	10	0.4	10	0.5	5*/5*	2	10	100	300	1.5	10	
H11D2	20	10	10	0.4	10	0.5	5*/5*	2	10	100	300	1.5	10	

3

Table 9. Triac Driver Output
Pinout: 1-Anode, 2-Cathode, 3-N.C., 4-Main Terminal, 5-Substrate, 6-Main Terminal (Style 6)

Device	Peak Blocking Voltage Min	LED Trigger Current-I _{FT} (V _{TM} = 3 V) mA Max	Zero Crossing Inhibit Voltage (at rated I _{FT}) Volts Max	Operating Voltage Vac Pk	dv/dt V/μs Typ
MOC3009	250	30	—	125	10
MOC3010	250	15	—	125	10
MOC3011	250	10	—	125	10
MOC3012	250	5	—	125	10
MOC3020	400	30	—	125/220	10
MOC3021	400	15	—	125/220	10
MOC3022	400	10	—	125/220	10
MOC3023	400	5	—	125/220	10
MOC3031	250	15	20	125	2000
MOC3032	250	10	20	125	2000
MOC3033	250	5	20	125	2000
MOC3041	400	15	20	125/240	2000
MOC3042	400	10	20	125/240	2000
MOC3043	400	5	20	125/240	2000
MOC3061	600	15	20	280	1500
MOC3062	600	10	20	280	1500
MOC3063	600	5	20	280	1500
MOC3081	800	15	20	320	1500
MOC3082	800	10	20	320	1500
MOC3083	800	5	20	320	1500

Table 10. Schmitt Trigger Output
Pinout: 1-Anode, 2-Cathode, 3-N.C., 4-Output, 5-Ground, 6-V_{CC} (Style 5)

Device	Threshold Current On mA Max	Threshold Current Off mA Min	I _{F(off)} /I _{F(on)}		V _{CC}		t _r t _f μs Typ	V _{ISO} Vac Pk
			Min	Max	Min	Max		
H11L1	1.6	0.3	0.5	0.9	3	15	0.1	7500
H11L2	10	0.3	0.5	0.9	3	15	0.1	7500
MOC5007	1.6	0.3	0.5	0.9	3	15	0.1	7500
MOC5008	4	0.3	0.5	0.9	3	15	0.1	7500
MOC5009	10	0.3	0.5	0.9	3	15	0.1	7500

Devices listed in bold, italic are Motorola preferred devices.

Optoisolators
6-Pin Surface Mount



Table 11. Transistor Output
 Pinout: 1-Anode, 2-Cathode, 3-N.C., 4-Emitter, 5-Collector, 6-Base (Style 1)

(S) CASE 730C-04
 (F) CASE 730F-04

Device	Current Transfer Ratio (CTR)			V _{CE(sat)}			t _r /t _f or t _{on} */t _{off} * Typ					V _{(BR)CEO}	V _F	
	% Min	@ I _F mA	V _{CE} Volts	Volts Max	I _F mA	I _C mA	μs @ I _C mA	V _{CC} Volts	R _L Ω	I _F mA	Volts Min	Volts Max	@ I _F mA	
TIL112S,F	2	10	5	0.5	50	2	2/2	2	10	100		20	1.5	10
TIL111S,F	8	16	0.4	0.4	16	2	5/5	2	10	100		30	1.4	16
4N27S,F	10	10	10	0.5	50	2	1.2/1.3	10	10	100		30	1.5	10
4N28S,F	10	10	10	0.5	50	2	1.2/1.3	10	10	100		30	1.5	10
4N38S,F	10	10	10	1	20	4	1.6/2.2	10	10	100		80	1.5	10
H11A4S,F	10	10	10	0.4	10	0.5	1.2/1.3	2	10	100		30	1.5	10
4N25S,F	20	10	10	0.5	50	2	1.2/1.3	10	10	100		30	1.5	10
4N25AS,F	20	10	10	0.5	50	2	1.2/1.3	10	10	100		30	1.5	10
4N26S,F	20	10	10	0.5	50	2	1.2/1.3	10	10	100		30	1.5	10
H11A2S,F	20	10	10	0.4	10	0.5	1.2/1.3	2	10	100		30	1.5	10
H11A3S,F	20	10	10	0.4	10	0.5	1.2/1.3	2	10	100		30	1.5	10
H11A520S,F	20	10	10	0.4	20	2	5*/5*	2	10	100		30	1.5	10
H11AV3S,F	20	10	10	0.4	20	2	5*/4*	2	10	100		70	1.5	10
MCT2S,F	20	10	10	0.4	16	2	1.2/1.3		5	2k	15	30	1.5	20
MCT2ES,F	20	10	10	0.4	16	2	1.2/1.3	2	10	100		30	1.5	20
TIL116S,F	20	10	10	0.4	15	2.2	5/5	2	10	100		30	1.5	60
H11A5S,F	30	10	10	0.4	10	0.5	1.2/1.3	2	10	100		30	1.7	10
CNX35S,F	40-160	10	0.4	0.4	10	2	3/3*	2	5	100		30	1.5	10
CNX36S,F	80-200	10	0.4	0.4	10	4	8/6*	2	5	100		30	1.5	10
CNX83S,F	40	10	0.4	0.4	10	4	3/3*	2	5	100		50	1.5	10
CNY17-1S,F	40-80	10	5	0.4	10	2.5	1.6/2.3		5	75	10	70	1.65	60
MCT271S,F	45-90	10	10	0.4	16	2	4.9*/4.5*	2	5	100		30	1.5	20
MOC8100S,F	50	1	5	0.5	1	0.1	3.8/5.6	2	10	100		30	1.4	1
H11A1S,F	50	10	10	0.4	10	0.5	1.2/1.3	2	10	100		30	1.5	10
H11A550S,F	50	10	10	0.4	20	2	5*/5*	2	10	100		30	1.5	10
H11AV2S,F	50	10	10	0.4	20	2	5*/4*	2	10	100		70	1.5	10
TIL117S,F	50	10	10	0.4	10	0.5	5/5	2	10	100		30	1.4	16
TIL126S,F	50	10	10	0.4	10	1	2/2	2	10	100		30	1.4	10
SL5501S,F	45-250	10	0.4	0.4	20	2	20*/50*		5	1k	16	30	1.3	20
CNY17-2S,F	63-125	10	5	0.4	10	2.5	1.6/2.3		5	75	10	70	1.65	60
MCT275S,F	70-210	10	10	0.4	16	2	4.5*/3.5*	2	5	100		80	1.5	20
MCT272S,F	75-150	10	10	0.4	16	2	6*/5.5*	2	5	100		30	1.5	20
4N35S,F	100	10	10	0.3	10	0.5	3.2/4.7	2	10	100		30	1.5	10
4N36S,F	100	10	10	0.3	10	0.5	3.2/4.7	2	10	100		30	1.5	10
4N37S,F	100	10	10	0.3	10	0.5	3.2/4.7	2	10	100		30	1.5	10
H11A5100S,F	100	10	10	0.4	20	2	5*/5*	2	10	100		30	1.5	10
CNY17-3S,F	100-200	10	5	0.4	10	2.5	1.6/2.3		5	75	10	70	1.65	60
SL5500S,F	50-300	10	0.4	0.4	50	10	20*/50*		5	1k	16	30	1.3	20
H11AV1S,F	100-300	10	10	0.4	20	2	5*/4*	2	10	100		70	1.5	10
MCT273S,F	125-250	10	10	0.4	16	2	7.6*/6.6*	2	5	100		30	1.5	20
MCT274S,F	225-400	10	10	0.4	16	2	9.1*/7.9*	2	5	100		30	1.5	20

Devices listed in bold, italic are Motorola preferred devices.

Optoisolators
6-Pin Surface Mount (continued)



Table 12. Transistor Output with No Base Connection
Pinout: 1-Anode, 2-Cathode, 3-N.C., 4-Emitter, 5-Collector, 6-N.C. (Style 3)

(S) CASE 730C-04
(F) CASE 730F-04

Device	Current Transfer Ratio (CTR)			V _{CE(sat)}			t _r /t _f or t _{on} */t _{off} * Typ					V _{(BR)CEO} Volts Min	V _F	
	% Min	@ I _F mA	V _{CE} Volts	Volts Max	@ I _F mA	I _C mA	μs @ I _C mA	V _{CC} Volts	R _L Ω	I _F mA	Volts Max		@ I _F mA	
MOC8101S,F	50-80	10	10	0.4	5	0.5	3.2/4.7	2	10	100		30	1.5	10
MOC8102S,F	73-117	10	10	0.4	5	0.5	3.2/4.7	2	10	100		30	1.5	10
MOC8103S,F	108-173	10	10	0.4	5	0.5	3.2/4.7	2	10	100		30	1.5	10
MOC8104S,F	160-256	10	10	0.4	5	0.5	3.2/4.7	2	10	100		30	1.5	10
MOC8111S,F	20	10	10	0.4	10	0.5	3.2/4.7	2	10	100		30	1.5	10
CNX82S,F	40	10	0.4	0.4	10	4	3/3*	2	5	100		50	1.5	10
MOC8112S,F	50	10	10	0.4	10	0.5	3.2/4.7	2	10	100		30	1.5	10
MOC8113S,F	100	10	10	0.4	10	0.5	3.2/4.7	2	10	100		30	1.5	10

Table 13. AC Input – Transistor Output
Pinout: 1-LED 1 Anode/LED 2 Cathode, 2-LED 1 Cathode/LED 2 Anode, 3-N.C., 4-Emitter, 5-Collector, 6-Base (Style 8)

H11AA1S,F	20	±10	10	0.4	±10	0.5						30	1.5	±10
H11AA2S,F	10	±10	10	0.4	±10	0.5						30	1.8	±10
H11AA3S,F	50	±10	10	0.4	±10	0.5						30	1.5	±10
H11AA4S,F	100	±10	10	0.4	±10	0.5						30	1.5	±10

Table 14. AC Input – Resistor Darlington Output
Pinout: 1-LED 1 Anode/LED 2 Cathode, 2-LED 1 Cathode/LED 2 Anode, 3-N.C., 4-Emitter, 5-Collector, 6-Base (Style 8)

MOC8060S,F	1000	±10	10	2	±10	100						50	1.5	±10
------------	------	-----	----	---	-----	-----	--	--	--	--	--	----	-----	-----

Table 15. Darlington Output
Pinout: 1-Anode, 2-Cathode, 3-N.C., 4-Emitter, 5-Collector, 6-Base (Style 1)

4N31S,F	50	10	10	1.2	8	2	0.6*/17*	50	10		200	30	1.5	10
4N29S,F	100	10	10	1	8	2	0.6*/17*	50	10		200	30	1.5	10
4N30S,F	100	10	10	1	8	2	0.6*/17*	50	10		200	30	1.5	10
H11B25S,F	100	10	5	1	50	50	125*/100*	10	10	100		55	1.5	20
MCA230S,F	100	10	5	1	50	50	10/35		10	100	50	30	1.5	20
MCA255S,F	100	10	5	1	50	50	10/35		10	100	50	55	1.5	20
H11B2S,F	200	1	5	1	1	1	1/2	10	10	100		25	1.5	10
MCA231S,F	200	1	1	1.2	10	50	80	10	10	100		30	1.5	20
TIL113S,F	300	10	1.25	1	50	125	300	125	15	100		30	1.5	10
4N32S,F	500	10	10	1	8	2	0.6*/45*	50	10		200	30	1.5	10
4N33S,F	500	10	10	1	8	2	0.6*/45*	50	10		200	30	1.5	10
H11B1S,F	500	1	5	1	1	1	1/2	10	10	100		25	1.5	10
MOC8080S,F	500	10	5	1	1	1	1/2		10	100	5	55	1.5	10

Table 16. Darlington Output with No Base Connection
Pinout: 1-Anode, 2-Cathode, 3-N.C., 4-Emitter, 5-Collector, 6-N.C. (Style 3)

MOC119S,F	300	10	2	1	10	10	1/2	2.5	10	100		30	1.5	10
TIL119S,F	300	10	2	1	10	10	300	2.5	10	100		30	1.5	10
MOC8030S,F	300	10	1.5				1/2		50	100	10	80	2	10
MOC8020S,F	500	10	5				1/2		50	100	10	50	2	10
MOC8050S,F	500	10	1.5				1/2		50	100	10	80	2	10
MOC8021S,F	1000	10	5				1/2		50	100	10	50	2	10

For Surface Mountable standard leadform, Order "S" suffix devices; e.g., MOC3043S.
For low profile Surface Mountable leadform, Order "F" suffix devices; e.g., MOC5007F.
For 24 mm Tape and Reel, add R2 suffix to the 6-pin optoisolator part number; e.g., H11A1SR2. (See Tape and Reel Specifications Section for more information)

Devices listed in bold, italic are Motorola preferred devices.

3

Optoisolators

6-Pin Surface Mount (continued)



(S) CASE 730C-04
(F) CASE 730F-04

Table 17. Resistor Darlington Output
Pinout: 1-Anode, 2-Cathode, 3-N.C., 4-Emitter, 5-Collector, 6-Base (Style 1)

Device	Current Transfer Ratio (CTR)			V _{CE(sat)}			t _r /t _f or t _{on} */t _{off} * Typ					V(BR)CEO		V _F	
	% Min	@ I _F mA	V _{CE} Volts	Volts Max	@ I _F mA	I _C mA	μs @ I _C mA	V _{CC} Volts	R _L Ω	I _F mA	Volts Min	Volts Max	@ I _F mA		
<i>H11G1S,F</i>	1000	10	1	1	1	1	5*/100*	5	100	10	100	1.5	10		
<i>H11G2S,F</i>	1000	10	1	1	1	1	5*/100*	5	100	10	80	1.5	10		
<i>H11G3S,F</i>	200	1	5	1.2	50	20	5*/100*	5	100	10	55	1.5	10		

Table 18. High Voltage Transistor Output
Pinout: 1-Anode, 2-Cathode, 3-N.C., 4-Emitter, 5-Collector, 6-Base (Style 1)

<i>MOC8204S,F</i>	20	10	10	0.4	10	0.5	5*/5*	2	10	100	400	1.5	10
<i>H11D1S,F</i>	20	10	10	0.4	10	0.5	5*/5*	2	10	100	300	1.5	10
<i>H11D2S,F</i>	20	10	10	0.4	10	0.5	5*/5*	2	10	100	300	1.5	10

Table 19. Triac Driver Output
Pinout: 1-Anode, 2-Cathode, 3-N.C., 4-Main Terminal, 5-Substrate, 6-Main Terminal (Style 6)

Device	Peak Blocking Voltage	LED Trigger Current-I _{FT} (V _{TM} = 3 V) mA Max	Zero Crossing Inhibit Voltage (at rated I _{FT}) Volts Max	Operating Voltage Vac Pk	dv/dt V/μs Typ
<i>MOC3009S,F</i>	250	30	—	125	10
<i>MOC3010S,F</i>	250	15	—	125	10
<i>MOC3011S,F</i>	250	10	—	125	10
<i>MOC3012S,F</i>	250	5	—	125	10
<i>MOC3020S,F</i>	400	30	—	125/220	10
<i>MOC3021S,F</i>	400	15	—	125/220	10
<i>MOC3022S,F</i>	400	10	—	125/220	10
<i>MOC3023S,F</i>	400	5	—	125/220	10
<i>MOC3031S,F</i>	250	15	20	125	2000
<i>MOC3032S,F</i>	250	10	20	125	2000
<i>MOC3033S,F</i>	250	5	20	125	2000
<i>MOC3041S,F</i>	400	15	20	125/220	2000
<i>MOC3042S,F</i>	400	10	20	125/220	2000
<i>MOC3043S,F</i>	400	5	20	125/220	2000
<i>MOC3061S,F</i>	600	15	20	280	1500
<i>MOC3062S,F</i>	600	10	20	280	1500
<i>MOC3063S,F</i>	600	5	20	280	1500
<i>MOC3081S,F</i>	800	15	20	320/280	1500
<i>MOC3082S,F</i>	800	10	20	320/280	1500
<i>MOC3083S,F</i>	800	5	20	320/280	1500

Table 20. Schmitt Trigger Output
Pinout: 1-Anode, 2-Cathode, 3-N.C., 4-Output, 5-Ground, 6-V_{CC} (Style 5)

Device	Threshold Current On mA Max	Threshold Current Off mA Min	I _{F(off)} /I _{F(on)}		V _{CC}		t _r , t _f μs Typ	V _{ISO} Vac Pk
			Min	Max	Min	Max		
<i>H11L1S,F</i>	1.6	0.3	0.5	0.9	3	15	0.1	3535
<i>H11L2S,F</i>	10	0.3	0.5	0.9	3	15	0.1	3535
<i>MOC5007S,F</i>	1.6	0.3	0.5	0.9	3	15	0.1	

For Surface Mountable standard leadform, Order "S" suffix devices; e.g., MOC3043S.

For low profile Surface Mountable leadform, Order "F" suffix devices; e.g., MOC5007F.

For 24 mm Tape and Reel, add R2 suffix to the 6-pin optoisolator part number; e.g., H11A1SR2. (See Tape and Reel Specifications Section for more information)

Devices listed in bold, italic are Motorola preferred devices.

Optoisolators

6-Pin Surface Mount (continued)

Table 20. Schmitt Trigger Output (continued)

Device	Threshold Current On mA Max	Threshold Current Off mA Min	I _{F(off)} /I _{F(on)}		V _{CC}		t _p , t _f μs Typ	V _{ISO} Vac Pk
			Min	Max	Min	Max		
MOC5008S,F	4	0.3	0.5	0.9	3	15	0.1	
MOC5009S,F	10	0.3	0.5	0.9	3	15	0.1	

For Surface Mountable standard leadform, Order "S" suffix devices; e.g., MOC3043S.

For low profile Surface Mountable leadform, Order "F" suffix devices; e.g., MOC5007F.

For 24 mm Tape and Reel, add R2 suffix to the 6-pin optoisolator part number; e.g., H11A1SR2. (See Tape and Reel Specifications Section for more information)



Small Outline — Surface Mount



CASE 846-01
SO-8 DEVICES

Table 21. Transistor Output

Pinout: 1-Anode, 2-Cathode, 3-N.C., 4-N.C., 5-Emitter, 6-Collector, 7-Base, 8-N.C. (Style 1)

Device	Marking	Current Transfer Ratio			V _{CE(sat)}			t _r /t _f Typ				V _{(BR)CEO}	V _F	
		% Min	@ mA	I _F mA	V _{CE} Volts	Volts Max	@ mA	I _C mA	μs	@ mA	V _{CC} Volts	R _L Ω	Volts Min	Volts Max
<i>MOC205R1/R2</i>	205	40-80	10	10	0.4	10	2	1.6	2	10	100	70	1.5	10
<i>MOC206R1/R2</i>	206	63-125	10	10	0.4	10	2	1.6	2	10	100	70	1.5	10
<i>MOC207R1/R2</i>	207	100-200	10	10	0.4	10	2	1.6	2	10	100	70	1.5	10
<i>MOC211R1/R2</i>	211	20	10	10	0.4	10	2	3.2	2	10	100	30	1.5	10
<i>MOC212R1/R2</i>	212	50	10	10	0.4	10	2	3.2	2	10	100	30	1.5	10
<i>MOC213R1/R2</i>	213	100	10	10	0.4	10	2	3.2	2	10	100	30	1.5	10
<i>MOC215R1/R2</i>	215	20	10	5	0.4	1	0.1	3.2	2	10	100	30	1.3	1
<i>MOC216R1/R2</i>	216	50	10	5	0.4	1	0.1	3.2	2	10	100	30	1.3	1
<i>MOC217R1/R2</i>	217	100	10	5	0.4	1	0.1	3.2	2	10	100	30	1.3	1

Table 22. Darlington Output

Pinout: 1-Anode, 2-Cathode, 3-N.C., 4-N.C., 5-Emitter, 6-Collector, 7-Base, 8-N.C. (Style 1)

<i>MOC221R1/R2</i>	221	100	1	5	1	1	0.5	2	5	10	100	30	1.3	1
<i>MOC222R1/R2</i>	222	200	1	5	1	1	0.5	2	5	10	100	30	1.3	1
<i>MOC223R1/R2</i>	223	500	1	5	1	1	0.5	2	5	10	100	30	1.3	1

All devices are shipped in tape and reel format. (See Tape and Reel Specifications Section for more information.)

Devices listed in bold, italic are Motorola preferred devices.

POWER OPTO™ Isolators

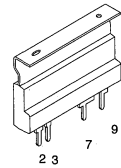

CASE 417-02
PLASTIC PACKAGE

Table 23. POWER OPTO Isolator 2 Amp Zero-Cross Triac Output
Pinout: (1,4,5,6,8 No Pin), 2 – LED Cathode, 3– LED Anode, 7-Main Terminal, 9-Main Terminal)

Device	Peak Blocking Voltage (Volts) Min	Led Trigger Current If T (V _{TM} = 2 V) mA Max	On State Voltage V _{TM} (Rated I _{FT} I _{TM} = 2 A) (Volts) Max	Zero Crossing Inhibit Voltage (I _F = Rated I _{FT}) (Volts) Max	Operating Voltage Vac rms (Volts)	dv/dt (static) (V _{JN} = 200 V) (V/μs) Min
<i>MOC2A40-5/F</i>	400	5	1-3	10	125	400
<i>MOC2A40-10/F</i>	400	10	1-3	10	125	400
<i>MOC2A60-5/F</i>	600	5	1-3	10	125/220	400
<i>MOC2A60-10/F</i>	600	10	1-3	10	125/220	400

No suffix = Style 2 (Standard Heat Tab), "F" suffix = Style 1 (Flush Mount Heat Tab).

3

Emitters/Detectors

Infrared Emitting Diodes

Motorola's infrared emitting diodes are made by the liquid phase epitaxial process for long life and stability. They provide high power output and quick response at 660 nm, 850 nm or 940 nm with low input drive current.

Table 24. Infrared Emitting Diodes

Device	Power Output		Emission Angle Typ	Peak Emission Wavelength nm Typ	Forward Voltage		Case/Style
	μW Typ	I_F mA			@ I_F Max	I_F mA	
<i>MLED91</i>	2500	50	60°	940	1.8	50	422A-01/1
<i>MLED96</i>	4000	100	60°	660	2.2	60	422A-01/4
<i>MLED97</i>	2500	100	60°	850	2	100	422A-01/4
<i>MLED81</i>	16000	100	60°	940	1.7	100	279B-01/1
MLED930	650	100	30°	940	1.5	50	209-01/1

Silicon Photodetectors

A variety of silicon photodetectors are available, varying from simple PIN diodes to complex, single chip 400 volt triac drivers. They offer choices of viewing angle and size in either economical plastic cases or rugged, hermetic metal cans.

Table 25. PIN Photodiodes – Response Time = 1 ns Typ

Device	Light Current @ $V_R = 20\text{ V}$, $H = 5\text{ mW/cm}^2$ μA	Dark Current @ $V_R = 20\text{ V}$ nA (Max)	Case/Style
MRD500	9	2	209-02/1
MRD510	2	2	210-01/1
<i>MRD921</i>	4	10	422A-01/1
<i>MRD821</i>	250	60	381-01/1

Table 26. Phototransistors

Device	Light Current @ $V_{CC} = 20$, $H = 5\text{ mW/cm}^2$ mA (Typ)	$V_{(BR)CEO}$ Volts (Min)	t_r/t_f @ $V_{CC} = 20$, $I_L = 1000\text{ }\mu\text{A}$ μs (Typ)	Case/Style
MRD310	3.5	50	2/2.5	82-05/1
MRD300	8	50	2/2.5	
MRD3050	0.1 Min	30	2/2.5	
MRD3056	2 Min	30	2/2.5	
t_{on}/t_{off} @ $V_{CC} = 5\text{ V}$				
<i>MRD901</i>	0.5	30	10/60	422A-01/2

All case 422 and 422A devices are available in Tape and Reel format. Add RLRE suffix to the part number; e.g. MRD901RLRE. (See Tape and Reel Specifications Section for more information)

Devices listed in bold, italic are Motorola preferred devices.

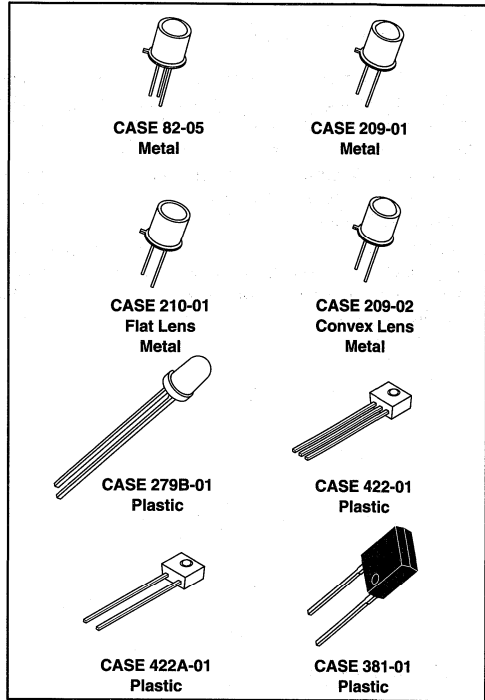

Table 27. Photodarlingtonns

Device	Light Current @ $V_{CC} = 5$, $H = 0.5\text{ mW/cm}^2$ mA (Typ)	$V_{(BR)CEO}$ Volts (Min)	t_r/t_f @ $V_{CC} = 5\text{ V}$ μs (Typ)	Case/Style
MRD370	10	40	15/40	82-05/1
MRD360	20	40	15/65	
<i>MRD911</i>	25	60	125/150	422A-01/2

Table 28. Photo Triac Drivers

Device	H_{FT} mW/cm ² Max	$I_{T(RMS)}$ mA Max	V_{DRM} Volts Peak Min	I_{DRM} nA Typ	Case/Style
MRD3010	5	100	250	10	82-05/3

Table 29. Photo Schmitt Triggers

Device	Threshold Current mA		$I_{F(off)}$ / $I_{F(on)}$ Typ	V_{CC} Volts	t_r/t_f μs Typ	Case/Style
	ON Max	OFF Min				
<i>MRD950</i>	20	1	0.75	3-15	0.1	422-01/3
MRD5009	20	1	0.75	3-15	0.1	82-05/1

Optointerrupters

An Optointerrupter consists of an infrared emitting diode facing a photodetector in a molded plastic housing. A slot in the housing between the emitter and detector provides a means for interrupting the signal transmission.

Motorola Optointerrupters are available in a wide selection of detector functions and housings to meet the designer's system requirements.

Motorola also offers custom designed packaging in a broad range of output functions, including those shown below, and more. Contact your nearest Motorola Sales Office or call us at 602-BIG-OPTO.

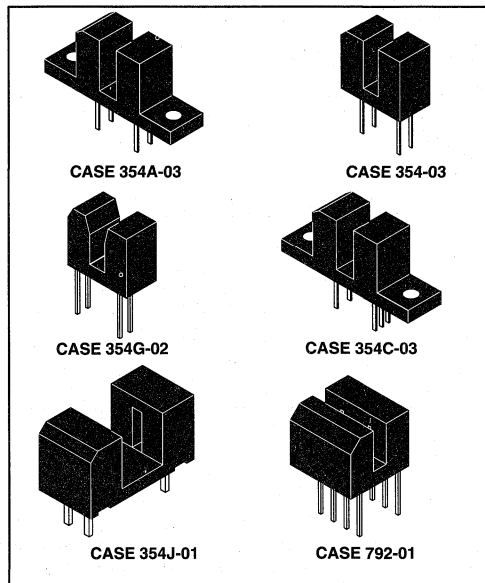

Table 30. Transistor

Device	Current Transfer Ratio			V _{CE(sat)}			V _F		Output Voltage Range	Package Case/Style
	% Min	I _F mA	V _{CE} Volts	Volts Max	I _F mA	I _C mA	Volts Max	I _F mA	Volts Max	
H21A1	5	20	5	0.4	30	1.8	1.7	60	30	354A-03/1
H21A2	10	20	5	0.4	20	1.8	1.7	60	30	354A-03/1
H21A3	20	20	5	0.4	20	1.8	1.7	60	30	354A-03/1
H22A1	5	20	5	0.4	30	1.8	1.7	60	30	354-03/1
H22A2	10	20	5	0.4	20	1.8	1.7	60	30	354-03/1
H22A3	20	20	5	0.4	20	1.8	1.7	60	30	354-03/1
MOC70T1	5	20	10	0.4	30	1.8	1.8	50	30	354A-03/1
MOC70T2	10	20	10	0.4	20	1.8	1.8	50	30	354A-03/1
MOC70P1	5	20	10	0.4	30	1.8	1.8	50	30	354J-01/1
MOC70P2	10	20	10	0.4	20	1.8	1.8	50	30	354J-01/1
MOC70V1	5	20	10	0.4	30	1.8	1.8	50	30	354G-02/1

Table 31. Dual Channel — Transistor

MOC70W1	0.5	20	10	0.4	20	0.1	1.8	50	30	792-01/2
---------	-----	----	----	-----	----	-----	-----	----	----	----------

Table 32. Darlington

H21B1	75	10	1.5	1	10	1.8	1.7	60	30	354A-023/1
H22B1	75	10	1.5	1	10	1.8	1.7	60	30	354-03/1

Table 33. Logic

Device	LED Trigger Current mA	Hysteresis Ratio I _{F(off)} /I _{F(on)}	t _(on) /t _(off) μs	V _F		Output Voltage Range Volts	Package Case/Style
				Volts Max	I _F mA		
MOC75T1	30	0.75	1.2	1.6	20	3-15	354C-03/1

Devices listed in bold, italic are Motorola preferred devices.

Fiber Optic Components

Emitters

Motorola offers two families of emitters for fiber optic systems.

- “**High Performance**” family in hermetic Case 210 for systems requiring greater than 100 MHz analog bandwidth over several kilometers. An additional family in Case 210 provides electrical performance (120 MHz) over moderate distances (500 meters) and is specified for use with hard clad silica fiber (Ensign-Bickford HCP — MO200T-06)
- “**POF**” family in unique Plastic Optic Fiber package is designed for applications requiring low cost, speeds up to 10 MHz and distances under 200 meters. (The POF package serves as its own connector.) It is used with inexpensive 1000 micron plastic core fiber (Eskal SH4001).

Detectors

Detectors are available with a variety of output configurations that greatly affect Bandwidth and Responsivity.

All Motorola fiber optic components, except the POF family, are designed for use with 100 micron (or larger) core glass fiber and fit directly into the following industry standard connector systems. AMP #228756-1, AMPHENOL #905-138-5001, OFTI #PCR001.

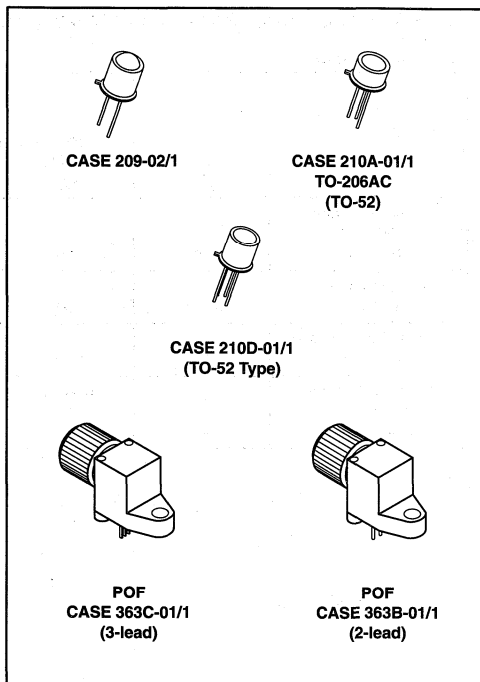

3

Table 34. Emitters

Device	Total Power Output		Response Time		λ nm Typ	Case/Style
	mW Typ	@ I _F mA	t _r ns Typ	t _f ns Typ		
MFOE71	3.5	100	25	25	820	363B-01/1
MFOE76	3.5	100	200	150	660	
MFOE200	3	100	250	250	940	209-02/1
MFOE1100	2.6	100	15	16	850	210A-01/1
MFOE1101	4	100	15	16	850	
MFOE1102	5	100	15	16	850	
MFOE1200	0.9	100	5	5	850	210A-01/1
MFOE1201	1.5	100	2.8	3.5	850	
MFOE1202	2.4	100	2.8	3.5	850	
MFOE1203	2.8	100	2.8	3.5	850	
MFOE1300	5	100	15	16	850	210A-01/1
MFOE1400	2.5	100	2.8	3.5	850	

Devices listed in bold, italic are Motorola preferred devices.

Fiber Optic Components: Detectors (continued)

Table 35. Detectors

Device	BWE MHz	Responsivity $\mu\text{A}/\mu\text{W}$ Typ	Response Time μs Typ		$V_{(BR)}$ Volts Min	Case/Style
			t_{on} t_r	t_{off} t_f		
Photo PIN Diodes MFOD1100 MFOD71	350 70	0.35 0.2	0.5 ns 1* ns	0.15 ns 1* ns	50 100	210A-01/1 363B-01/3
Phototransistors MFOD72	6 kHz	125	10*	60*	30	363B-01/2
Photodarlington MFOD73	2 kHz	1500	125*	150*	60	363B-01/2
Detector Preamps MFOD2404 MFOD2405	10 35	mV/μW 35 6	0.035 0.010	0.035 0.010	VCC Range 4-6 4-6	210D-01/1

Devices listed in bold, italic are Motorola preferred devices.

ACT Align Series Receptacle Mounted

Fiber Optic Transmitter and Receiver Components

Motorola ACT Align Fiber Optic Components eliminate the time consuming and often performance robbing process of aligning fiber optic components within commercial housings. Utilizing advanced techniques Motorola can install any Motorola fiber optic component into the connector of your choice and guarantee the listed performance characteristics.

- Guaranteed Performance
- Cost Effective Installation
- Improved Coupling Efficiency
- Lowers Connector Loss
- High Launched Power
- Industry Standard Connectors
- Designed for 100 Micron Core Fibers (62.5 and 50 Micron Core Fibers Available)
- MFOE1300/1400 Designed for use with 200 Micron Core Hard Clad Silica Fiber (Ensign-Bickford HCP-MO200T-06)
- Connectors Designed for Board or Panel Mounting
- If you desire another connector type, or are using a fiber core diameter other than stated, please contact us at 602-BIG-OPTO

Ordering Information

To order Fiber Optic Components simply add the connector suffix to the Motorola base device designation. For example: to order an MFOE1201 fiber optic emitter in an SMA low profile connector order part number MFOE1201SMA.

Table 36. Emitters

Device	Power Launched			Response Time		λ nm Typ
	μ W Min	Max	I_F mA	t_r ns Typ	t_f ns Typ	
MFOE200			100			940
MFOE1100	60	—	100	15	16	850
MFOE1101	120	240	100	15	16	850
MFOE1102	180	360	100	15	16	850
MFOE1200	60	—	100	5	5	850
MFOE1201	40	80	100	2.8	3.5	850
MFOE1202	75	150	100	2.8	3.5	850
MFOE1203	135	270	100	2.8	3.5	850
MFOE1300	1000	—	100	15	16	850
MFOE1400	800	—	100	2.8	3.5	850

Devices listed in bold, italic are Motorola preferred devices.

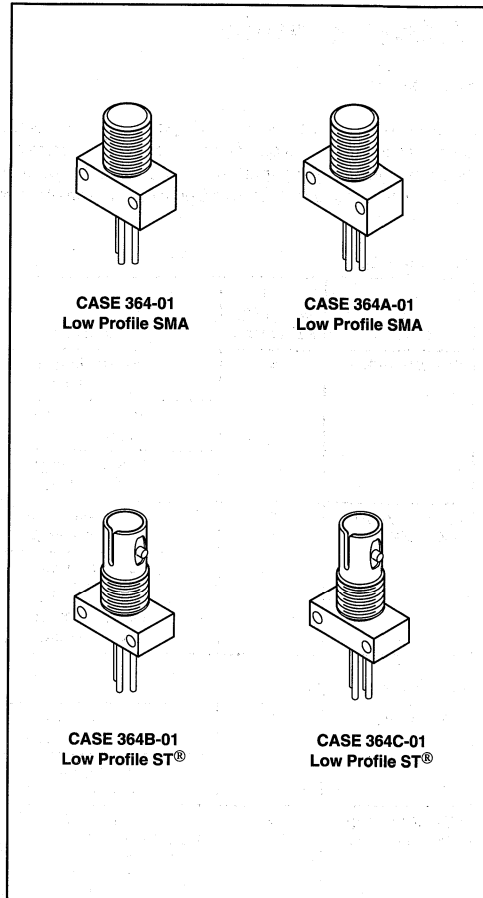

Table 37. Detectors

Device	BWE MHz	Responsivity μ A/ μ W Typ	Response Time μ s Typ		V(BR) Volts Min
			t_{on} t_r	t_{off} t_f	
MFOD1100	350	0.35	0.5 ns	0.5 ns	50

Photo Pin Diodes

MFOD1100	350	0.35	0.5 ns	0.5 ns	50
----------	-----	------	--------	--------	----

Detector Preamps

		mV/μ W			V _{CC} Range
MFOD2404	10	35	0.035	0.035	4-6
MFOD2405	35	6	0.01	0.01	4-6

Optoelectronic Chips

Motorola offers Optoelectronic Chips for use in hybrid assembly and other customer applications. These chips are the same high quality, high performance Light Emitting Diodes and Detectors utilized in Motorola Optoisolators and Discrete components.

Electrical Specifications and Ordering Information

- All dice have Aluminum front metallization (minimum 10000 Å) and Gold back metal (minimum 15000 Å).
- All wafers are .008 to .010 inch thick
- All wafers are unsawn and shipped in Anti-static protective containers
- Minimum order quantity is one whole wafer, see "Good Die Per Wafer" column for estimated die quantity
- All shipments in whole wafer increments

Table 38. LED

Chip Part Number	Die Geometry Reference #	Parameter	Symbol	Min	Typ	Max	Units	Estimated Good Chip Per Wafer
<i>MLEDC1000WP</i>	1	Peak Wavelength (I _F = 50 mA)	λ _p	—	940	—	nm	10450
		Total Power Out (I _F = 50 mA)	P _O	2	—	—	mW	
		Forward Voltage (I _F = 50 mA)	V _F	—	—	1.5	V	
<i>MFOEC1200WP</i> Fiber Optic	2	Peak Wavelength (I _F = 100 mAdc)	λ _p	—	850	—	nm	1470
		Total Power Out (I _F = 100 mA)	P _O	1.5	—	—	mW	
		Forward Voltage (I _F = 100 mA)	V _F	1	—	2.5	V	

Table 39. Pin Diode

<i>MRDC100WP</i>	3	Responsivity (V _R = 20 V, λ = 850 nm)	R	0.3	0.4	—	μA/μW	9860
		Dark Current (V _R = 20 V, H = 0)	I _D	—	—	10	nA	
<i>MFOEC1100WP</i> Fiber Optic	4	Responsivity (V _R = 5 V, λ = 850 nm, P = 10 μW)	R	0.3	0.4	—	μA/μW	9860
		Dark Current (V _R = 5 V, H = 0, R _L = 1 Mohm)	I _D	—	—	1	nA	

Table 40. Transistor

<i>MRDC200WP</i>	5	Light Current (V _{CE} = 5 V, H = 5 mW/cm ²)	I _L	0.8	—	22	mA	11600
		Collector-Emitter Breakdown Voltage (I _{CE} = 100 μA)	V _{(BR)CEO}	40	—	—	V	

Table 41. Darlington

<i>MRDC400WP</i>	6	Light Current (V _{CE} = 5 V, H = 1 mW/cm ²)	I _L	0.8	—	20	mA	14600
		Collector-Emitter Breakdown Voltage (I _{CE} = 1 mA)	V _{(BR)CEO}	45	—	—	V	

Devices listed in bold, italic are Motorola preferred devices.

Optoelectronic Chips (continued)

Table 42. Triac Driver

Chip Part Number	Die Geometry Reference #	Parameter	Symbol	Min	Typ	Max	Units	Estimated Good Chip Per Wafer
MRDC800WP Random Phase	7	Trigger Current ($\lambda = 940 \text{ nm}$, $V_{TM} = 3 \text{ V}$, $R_L = 150 \text{ ohm}$)	I_{FT}	—	5	10	mW/cm ²	5444
		On-State RMS Current (Full Cycle 50–60 Hz)	$I_T(\text{RMS})$	—	—	100	mA	
		Off-State Output Terminal Voltage	V_{DRM}	—	—	400	V	
		Peak Blocking Current ($V_{DRM} = 400 \text{ V}$)	I_{DRM}	—	10	100	nA	
MRDC600WP Zero Crossing	8	Trigger Current ($\lambda = 940 \text{ nm}$, $V_{TM} = 3 \text{ V}$, $R_L = 150 \text{ ohm}$)	I_{FT}	0	5	10	mW/cm ²	4180
		Peak Repetitive Current ($PW = 100 \mu\text{s}$, 120 pps)	I_T	—	—	300	mA	
		Off-State Output Terminal Voltage	V_{DRM}	—	—	600	V	
		Peak Blocking Current ($V_{DRM} = 400 \text{ V}$)	I_{DRM}	—	60	500	nA	
		Inhibit Voltage ($H = 20 \text{ mW/cm}^2$, MT1-MT2; voltage above which device will not trigger)	V_{IH}	—	10	20	V	

Devices are available in sawn wafer format by substituting the WP suffix with a CP suffix; e.g. use MRDC600CP to order MRDC600 in sawn wafer format.

3

Devices listed in bold, italic are Motorola preferred devices.

Optoelectronic Chips (continued)

Geometries, Chip Size, Bond Pad Size

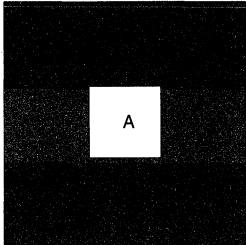
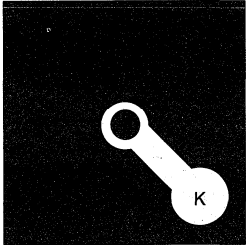
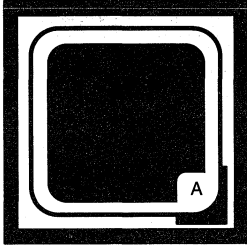
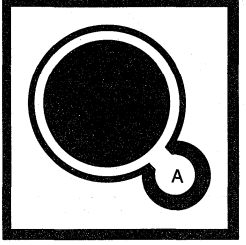
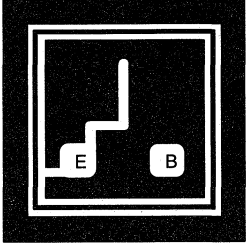
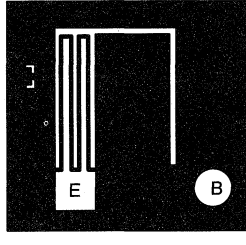
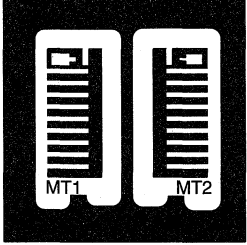
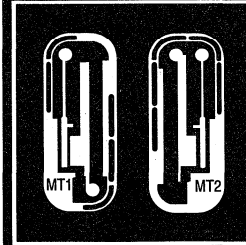
<p>1</p>  <p>Chip Size: 15 x 15 mils/0.4 x 0.4 mm Bond Pad Size: Anode — 4 x 4 mils/0.1 x 0.1 mm Cathode — 15 x 15 mils/0.4 x 0.4 mm</p>	<p>2</p>  <p>Chip Size: 24 x 24 mils/0.6 x 0.6 mm Bond Pad Size: Anode — 24 x 24 mils/0.6 x 0.6 mm Cathode — 3.5 mils dia./0.09 mm dia.</p>	<p>3</p>  <p>Chip Size: 30 x 30 mils/0.76 x 0.76 mm Bond Pad Size: Anode — 4.5 x 4.5 mils/0.11 x 0.11 mm Cathode — 30 x 30 mils/0.76 x 0.76 mm</p>
<p>4</p>  <p>Chip Size: 30 x 30 mils/0.76 x 0.76 mm Bond Pad Size: Anode — 4.0 mils dia./0.1 mm dia. Cathode — 30 x 30 mils/0.76 x 0.76 mm</p>	<p>5</p>  <p>Chip Size: 25 x 25 mils/0.64 x 0.64 mm Bond Pad Size: Emitter — .35 x 3.5 mils/0.09 x 0.09 mm Base — .35 x 3.5 mils/0.09 x 0.09 mm</p>	<p>6</p>  <p>Chip Size: 27 x 27 mils/0.69 x 0.69 mm Bond Pad Size: Emitter — .40 x 4.0 mils/0.1 x 0.1 mm Baser — .40 mils dia./0.1 mm dia.</p>
<p>7</p>  <p>Chip Size: 40 x 40 mils/1.0 x 1.0 mm Bond Pad Size: MT — .14.0 x 5.0 mils/0.1 x 0.13 mm MT — .24.0 x 5.0 mils/0.1 x 0.13 mm</p>	<p>8</p>  <p>Chip Size: 45 x 45 mils/1.14 x 1.14 mm Bond Pad Size: MT — .14.6 mils dia./0.12 mm dia. MT — .24.6 mils dia./0.12 mm dia.</p>	<p>A = Anode B = Base C = Collector E = Emitter G = Gate K = Cathode</p>

Front Metallization Thickness — a minimum of 10000 Å
Back Metallization Thickness — a minimum of 15000 Å

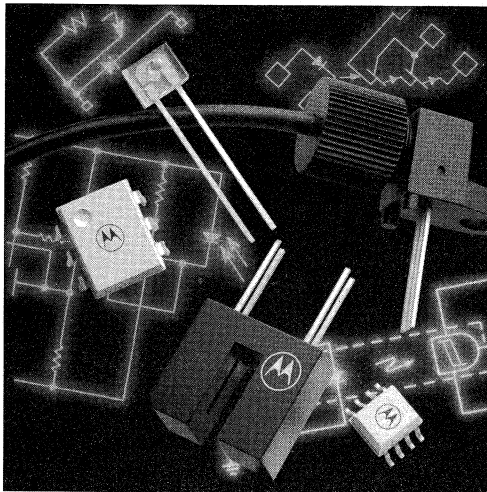

Section Four

Optoisolators/ Optocouplers

4N25 Series	4-3
4N29 Series	4-7
4N35 Series	4-11
4N38	4-15
CNY17-1 Series	4-19
H11A1 Series	4-23
H11AA1 Series	4-27
H11AV1 Series	4-30
H11B1 Series	4-34
H11D1 Series	4-38
H11G1 Series	4-41
H11L1 Series	4-44
MCT2	4-47
MOC119	4-51
MOC3009 Series	4-55
MOC3020 Series	4-59
MOC3031 Series	4-63
MOC3041 Series	4-67
MOC3061 Series	4-71
MOC3081 Series	4-75
MOC5007 Series	4-79
MOC8020	4-82
MOC8030	4-86
MOC8060	4-90
MOC8080	4-94
MOC8100	4-98
MOC8101 Series	4-102
MOC8111 Series	4-105
MOC8204 Series	4-109

GLOBAL OPTOISOLATORS

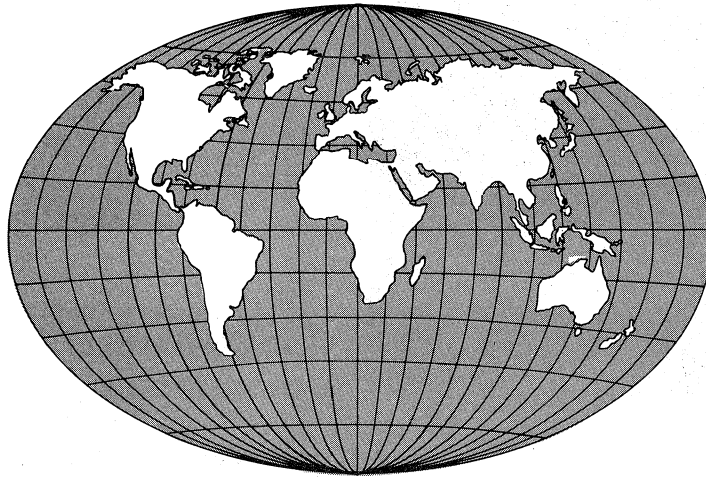

4

There is no need to worry about meeting the broad range of requirements imposed throughout the world. With Motorola optoisolators, your marketplace is indeed global.

Motorola 6-PIN DIP Optoisolators Feature:

- “Global” Safety Regulatory Approvals: **VDE(1), UL, CSA, SETI, SEMKO, DEMKO, NEMKO, AUSTEL and BABT**
 - The Industry’s Highest Input-Output Voltage Isolation, Guaranteed and 100% tested — 7500 Vac Peak.
 - VDE approved per standard 0884/8.87(1) (Certificate number 62054), with additional approval to DIN IEC950/VDE0806 & VDVE0805, IEC65/VDE0860, VDE110b, covering all other standards with equal or less stringent requirements, including IEC204/VDE0113, VDE0160, VDE0832, VDE0833.
 - Special leadform available to satisfy VDE0884/8.87 requirement for 8 mm minimum creepage distance between input and output solder pads (add suffix “T” to part number). VDE 0884 testing is an option.
 - Surface mount leadforms are available for all 6-PIN DIP devices. To obtain standard profile “S” or low profile “F” stand off heights simply add the suffix to the end of the part number (ie. MOC8104S or MOC8104F).
 - Tape and Reel option available for both “S” and “F” Surface Mount leadform options (1,000 pieces per reel) add the suffix “R2” (ie. MOC8104FR2).
 - Available in a wide variety of output types — Transistor, Darlington, Schmitt Trigger, and Zero Cross/Random Phase Triac Drivers.
- (1) VDE 0884 testing is an option; the suffix letter “V” must be added to the part number.



6-Pin DIP Optoisolators Transistor Output

The 4N25/A, 4N26, 4N27 and 4N28 devices consist of a gallium arsenide infrared emitting diode optically coupled to a monolithic silicon phototransistor detector.

- Most Economical Optoisolator
- Meets or Exceeds all JEDEC Registered Specifications

Applications

- General Purpose Switching Circuits
- Interfacing and coupling systems of different potentials and impedances
- I/O Interfacing
- Solid State Relays

MAXIMUM RATINGS ($T_A = 25^\circ\text{C}$ unless otherwise noted)

Rating	Symbol	Value	Unit
INPUT LED			
Reverse Voltage	V_R	3	Volts
Forward Current — Continuous	I_F	60	mA
LED Power Dissipation @ $T_A = 25^\circ\text{C}$ with Negligible Power in Output Detector Derate above 25°C	P_D	120	mW
		1.41	mW/ $^\circ\text{C}$
OUTPUT TRANSISTOR			
Collector-Emitter Voltage	V_{CEO}	30	Volts
Emitter-Collector Voltage	V_{ECO}	7	Volts
Collector-Base Voltage	V_{CBO}	70	Volts
Collector Current — Continuous	I_C	150	mA
Detector Power Dissipation @ $T_A = 25^\circ\text{C}$ with Negligible Power in Input LED Derate above 25°C	P_D	150	mW
		1.76	mW/ $^\circ\text{C}$
TOTAL DEVICE			
Isolation Surge Voltage (1) (Peak ac Voltage, 60 Hz, 1 sec Duration)	V_{ISO}	7500	Vac
Total Device Power Dissipation @ $T_A = 25^\circ\text{C}$ Derate above 25°C	P_D	250 2.94	mW mW/ $^\circ\text{C}$
Ambient Operating Temperature Range (2)	T_A	-55 to +100	$^\circ\text{C}$
Storage Temperature Range	T_{stg}	-55 to +150	$^\circ\text{C}$
Soldering Temperature (10 sec, 1/16" from case)	T_L	260	$^\circ\text{C}$

(1) Isolation surge voltage is an internal device dielectric breakdown rating. For this test, Pins 1 and 2 are common, and Pins 4, 5 and 6 are common.

(2) Refer to Quality and Reliability Section for test information.

4N25*
4N25A*
4N26*
 [CTR = 20% Min]
4N27
4N28
 [CTR = 10% Min]

*Motorola Preferred Devices
 STYLE 1 PLASTIC

4



STANDARD THRU HOLE
 CASE 730A-04



"T" LEADFORM
 WIDE SPACED 0.4"
 CASE 730D-05



"S"/"F" LEADFORM
 SURFACE MOUNT
 CASE 730C-04
 (STANDARD PROFILE)



CASE 730F-04
 (LOW PROFILE)

SCHEMATIC

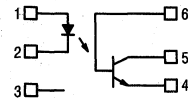

- PIN 1. LED ANODE
- 2. LED CATHODE
- 3. N.C.
- 4. EMITTER
- 5. COLLECTOR
- 6. BASE

4N25, 4N25A, 4N26, 4N27, 4N28

ELECTRICAL CHARACTERISTICS ($T_A = 25^\circ\text{C}$ unless otherwise noted)

Characteristic	Symbol	Min	Typ	Max	Unit
----------------	--------	-----	-----	-----	------

INPUT LED

Forward Voltage ($I_F = 10\text{ mA}$)	$T_A = 25^\circ\text{C}$	V_F	—	1.15	1.5	Volts
	$T_A = -55^\circ\text{C}$		—	1.3	—	
	$T_A = 100^\circ\text{C}$		—	1.05	—	
Reverse Leakage Current ($V_R = 3\text{ V}$)		I_R	—	—	100	μA
Capacitance ($V = 0\text{ V}$, $f = 1\text{ MHz}$)		C_J	—	18	—	pF

OUTPUT TRANSISTOR

Collector-Emitter Dark Current ($V_{CE} = 10\text{ V}$, $T_A = 25^\circ\text{C}$)	4N25,25A,26,27 4N28	I_{CEO}	—	1	50	nA
	($V_{CE} = 10\text{ V}$, $T_A = 100^\circ\text{C}$)	All Devices	I_{CEO}	—	1	—
Collector-Base Dark Current ($V_{CB} = 10\text{ V}$)		I_{CBO}	—	0.2	—	nA
Collector-Emitter Breakdown Voltage ($I_C = 1\text{ mA}$)		$V_{(BR)CEO}$	30	45	—	Volts
Collector-Base Breakdown Voltage ($I_C = 100\text{ }\mu\text{A}$)		$V_{(BR)CBO}$	70	100	—	Volts
Emitter-Collector Breakdown Voltage ($I_E = 100\text{ }\mu\text{A}$)		$V_{(BR)ECO}$	7	7.8	—	Volts
DC Current Gain ($I_C = 2\text{ mA}$, $V_{CE} = 5\text{ V}$)		h_{FE}	—	500	—	—
Collector-Emitter Capacitance ($f = 1\text{ MHz}$, $V_{CE} = 0$)		C_{CE}	—	7	—	pF
Collector-Base Capacitance ($f = 1\text{ MHz}$, $V_{CB} = 0$)		C_{CB}	—	19	—	pF
Emitter-Base Capacitance ($f = 1\text{ MHz}$, $V_{EB} = 0$)		C_{EB}	—	9	—	pF

COUPLED

Output Collector Current ($I_F = 10\text{ mA}$, $V_{CE} = 10\text{ V}$)	4N25,25A,26 4N27,28	I_C	2	7	—	mA
			1	5	—	
Collector-Emitter Saturation Voltage ($I_C = 2\text{ mA}$, $I_F = 50\text{ mA}$)		$V_{CE(sat)}$	—	0.15	0.5	Volts
Turn-On Time ($I_F = 10\text{ mA}$, $V_{CC} = 10\text{ V}$, $R_L = 100\text{ }\Omega$)		t_{on}	—	2.8	—	μs
Turn-Off Time ($I_F = 10\text{ mA}$, $V_{CC} = 10\text{ V}$, $R_L = 100\text{ }\Omega$)		t_{off}	—	4.5	—	μs
Rise Time ($I_F = 10\text{ mA}$, $V_{CC} = 10\text{ V}$, $R_L = 100\text{ }\Omega$)		t_r	—	1.2	—	μs
Fall Time ($I_F = 10\text{ mA}$, $V_{CC} = 10\text{ V}$, $R_L = 100\text{ }\Omega$)		t_f	—	1.3	—	μs
Isolation Voltage ($f = 60\text{ Hz}$, $t = 1\text{ sec}$)		V_{ISO}	7500	—	—	Vac(pk)
Isolation Resistance ($V = 500\text{ V}$)		R_{ISO}	10^{11}	—	—	Ω
Isolation Capacitance ($V = 0\text{ V}$, $f = 1\text{ MHz}$)		C_{ISO}	—	0.2	—	pF

TYPICAL CHARACTERISTICS

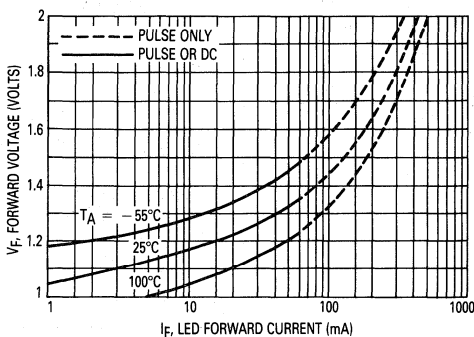

Figure 1. LED Forward Voltage versus Forward Current

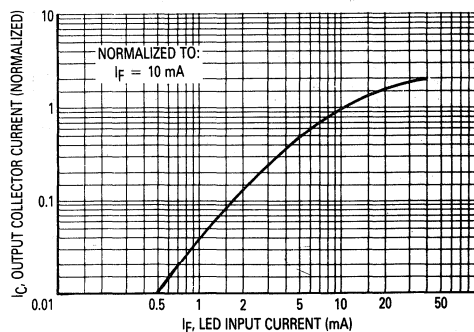

Figure 2. Output Current versus Input Current

4N25, 4N25A, 4N26, 4N27, 4N28

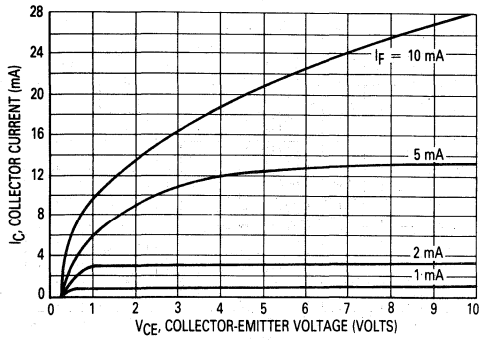

Figure 3. Collector Current versus Collector-Emitter Voltage

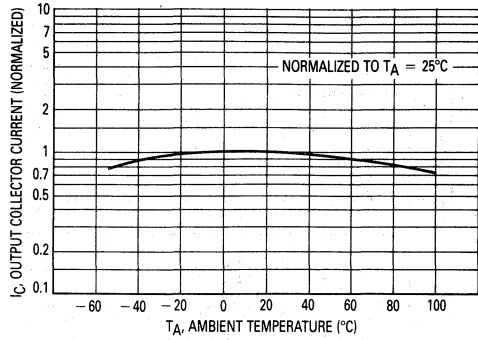

Figure 4. Output Current versus Ambient Temperature

4

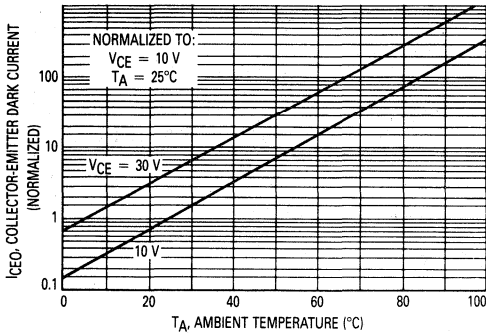

Figure 5. Dark Current versus Ambient Temperature

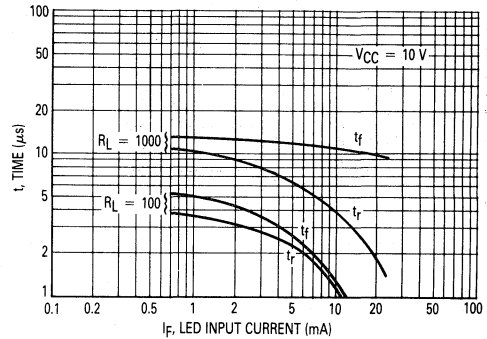

Figure 6. Rise and Fall Times

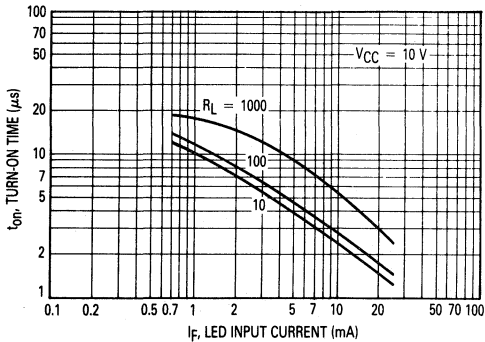

Figure 7. Turn-On Switching Times

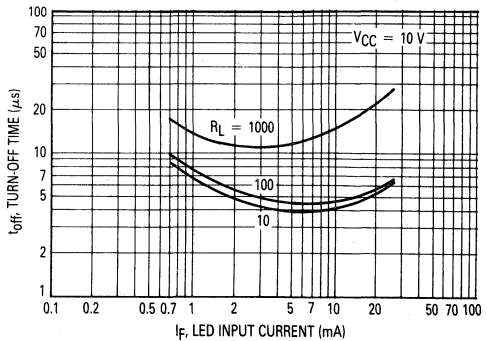

Figure 8. Turn-Off Switching Times

4N25, 4N25A, 4N26, 4N27, 4N28

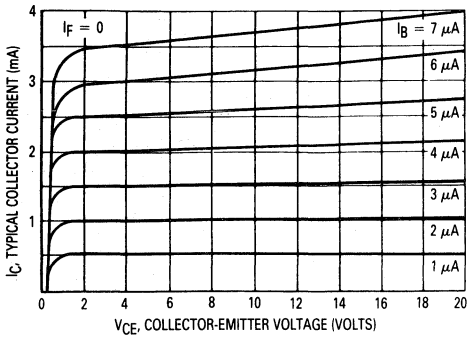

Figure 9. DC Current Gain (Detector Only)

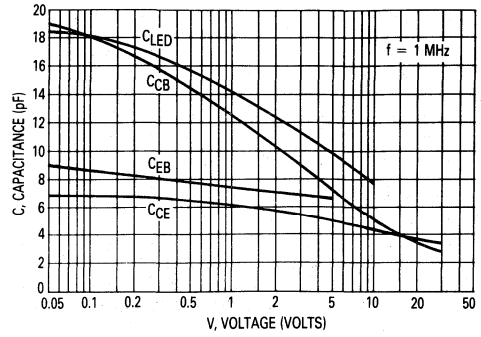

Figure 10. Capacitances versus Voltage

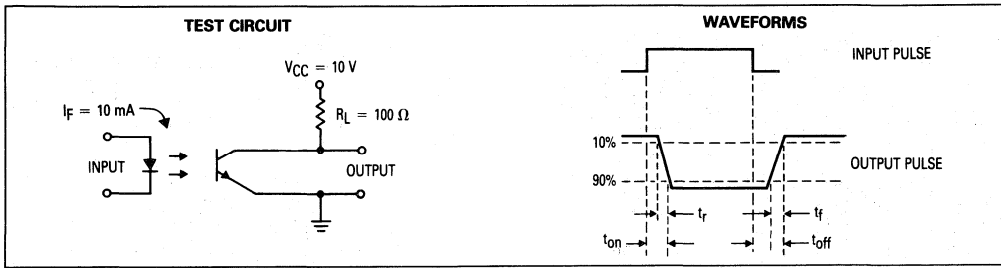

Figure 11. Switching Times

MOTOROLA SEMICONDUCTOR TECHNICAL DATA



6-Pin DIP Optoisolators Darlington Output

The 4N29/A, 4N30, 4N31, 4N32/A and 4N33 devices consist of a gallium arsenide infrared emitting diode optically coupled to a monolithic silicon photodarlington detector. It is designed for use in applications requiring high sensitivity at low input currents.

- High Sensitivity to Low Input Drive Current
- Meets or Exceeds all JEDEC Registered Specifications

Applications

- Low Power Logic Circuits
- Interfacing and coupling systems of different potentials and impedances
- Telecommunications Equipment
- Portable Electronics
- Solid State Relays

MAXIMUM RATINGS ($T_A = 25^\circ\text{C}$ unless otherwise noted)

Rating	Symbol	Value	Unit
--------	--------	-------	------

INPUT LED

Reverse Voltage	V_R	3	Volts
Forward Current — Continuous	I_F	60	mA
LED Power Dissipation @ $T_A = 25^\circ\text{C}$ Derate above 25°C	P_D	120 1.41	mW mW/ $^\circ\text{C}$

OUTPUT DETECTOR

Collector-Emitter Voltage	V_{CEO}	30	Volts
Emitter-Collector Voltage	V_{ECO}	5	Volts
Collector-Base Voltage	V_{CBO}	30	Volts
Collector Current — Continuous	I_C	150	mA
Detector Power Dissipation @ $T_A = 25^\circ\text{C}$ Derate above 25°C	P_D	150 1.76	mW mW/ $^\circ\text{C}$

TOTAL DEVICE

Isolation Surge Voltage (1) (Peak ac Voltage, 60 Hz, 1 sec Duration)	V_{ISO}	7500	Vac
Total Device Power Dissipation @ $T_A = 25^\circ\text{C}$ Derate above 25°C	P_D	250 2.94	mW mW/ $^\circ\text{C}$
Ambient Operating Temperature Range (2)	T_A	-55 to +100	$^\circ\text{C}$
Storage Temperature Range	T_{stg}	-55 to +150	$^\circ\text{C}$
Soldering Temperature (10 sec, 1/16" from case)	T_L	260	$^\circ\text{C}$

(1) Isolation surge voltage is an internal device dielectric breakdown rating. For this test, Pins 1 and 2 are common, and Pins 4, 5 and 6 are common.

(2) Refer to Quality and Reliability Section for test information.

4N29
4N29A
4N30*
[CTR = 100% Min]
4N31
[CTR = 50% Min]
4N32*
4N32A*
4N33
[CTR = 500% Min]

*Motorola Preferred Devices
STYLE 1 PLASTIC

4



STANDARD THRU HOLE
CASE 730A-04



"T" LEADFORM
WIDE SPACED 0.4"
CASE 730D-05



"S"/"F" LEADFORM
SURFACE MOUNT
CASE 730C-04
(STANDARD PROFILE)



CASE 730F-04
(LOW PROFILE)

SCHEMATIC

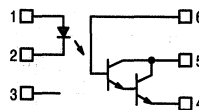

PIN 1. LED ANODE
2. LED CATHODE
3. N.C.
4. EMITTER
5. COLLECTOR
6. BASE

4N29, 4N29A, 4N30, 4N31, 4N32, 4N32A, 4N33

ELECTRICAL CHARACTERISTICS ($T_A = 25^\circ\text{C}$ unless otherwise noted)

Characteristic	Symbol	Min	Typ	Max	Unit
INPUT LED					
*Reverse Leakage Current ($V_R = 3\text{ V}$, $R_L = 1\text{ M ohms}$)	I_R	—	0.05	100	μA
*Forward Voltage ($I_F = 10\text{ mA}$)	V_F	—	1.34	1.5	Volts
Capacitance ($V_R = 0\text{ V}$, $f = 1\text{ MHz}$)	C	—	18	—	pF

OUTPUT DETECTOR ($T_A = 25^\circ\text{C}$ and $I_F = 0$, unless otherwise noted)

*Collector-Emitter Dark Current ($V_{CE} = 10\text{ V}$, Base Open)	I_{CEO}	—	—	100	nA
*Collector-Base Breakdown Voltage ($I_C = 100\ \mu\text{A}$, $I_E = 0$)	$V_{(BR)CBO}$	30	—	—	Volts
*Collector-Emitter Breakdown Voltage ($I_C = 100\ \mu\text{A}$, $I_B = 0$)	$V_{(BR)CEO}$	30	—	—	Volts
*Emitter-Collector Breakdown Voltage ($I_E = 100\ \mu\text{A}$, $I_B = 0$)	$V_{(BR)ECO}$	5	—	—	Volts
DC Current Gain ($V_{CE} = 5\text{ V}$, $I_C = 500\ \mu\text{A}$)	h_{FE}	—	16K	—	—

COUPLED ($T_A = 25^\circ\text{C}$ unless otherwise noted)

*Collector Output Current (1) ($V_{CE} = 10\text{ V}$, $I_F = 10\text{ mA}$, $I_B = 0$)	4N32, 4N33 4N29, 4N30 4N31	I_C	50 10 5	— — —	— — —	mA
Isolation Surge Voltage (2, 3) (60 Hz ac Peak, 1 Second)	*4N29, 4N32 *4N30, 4N31, 4N33	V_{ISO}	7500 2500 1500	— — —	— — —	Volts
Isolation Resistance (2) ($V = 500\text{ V}$)		R_{ISO}	—	10^{11}	—	Ohms
*Collector-Emitter Saturation Voltage (1) ($I_C = 2\text{ mA}$, $I_F = 8\text{ mA}$)	4N31 4N29, 4N39, 4N32, 4N33	$V_{CE(sat)}$	— —	— —	1.2 1	Volts
Isolation Capacitance (2) ($V = 0\text{ V}$, $f = 1\text{ MHz}$)		C_{ISO}	—	0.2	—	pF
Turn-On Time ($I_C = 50\text{ mA}$, $I_F = 200\text{ mA}$, $V_{CC} = 10\text{ V}$)		t_{on}	—	0.6	5	μs
Turn-Off Time ($I_C = 50\text{ mA}$, $I_F = 200\text{ mA}$, $V_{CC} = 10\text{ V}$)	4N29, 30, 31 4N32, 33	t_{off}	— —	17 45	40 100	μs

*Indicates JEDEC Registered Data.

(1) Pulse Test: Pulse Width = $300\ \mu\text{s}$, Duty Cycle $\leq 2\%$.

(2) For this test, Pins 1 and 2 are common and Pins 4, 5 and 6 are common.

(3) Isolation Surge Voltage, V_{ISO} , is an internal device dielectric breakdown rating.

TYPICAL CHARACTERISTICS

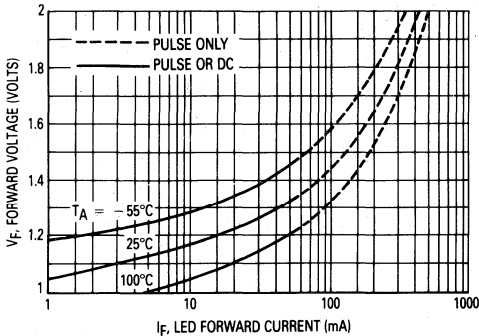

Figure 1. LED Forward Voltage versus Forward Current

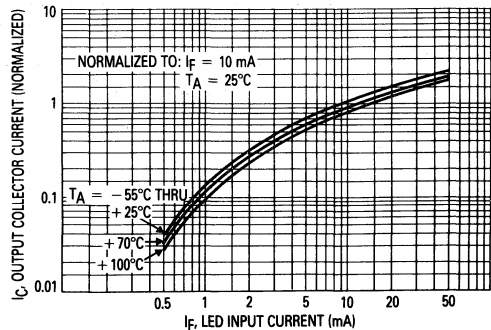

Figure 2. Output Current versus Input Current

4N29, 4N29A, 4N30, 4N31, 4N32, 4N32A, 4N33

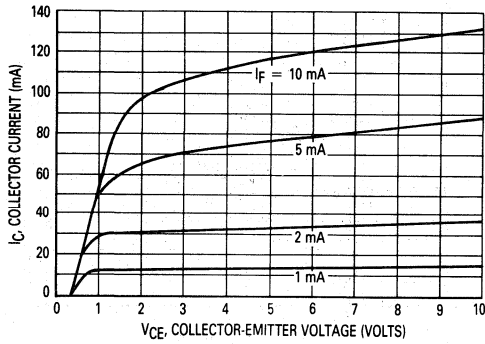

Figure 3. Collector Current versus Collector-Emitter Voltage

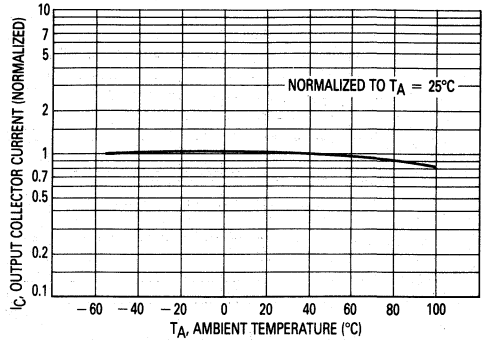

Figure 4. Output Current versus Ambient Temperature

4

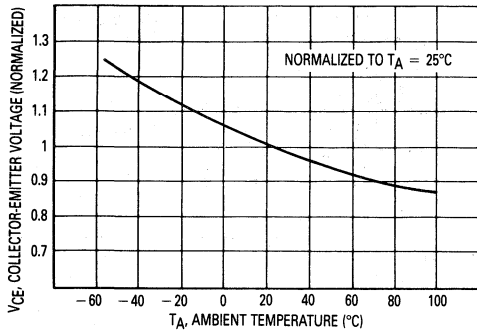

Figure 5. Collector-Emitter Voltage versus Ambient Temperature

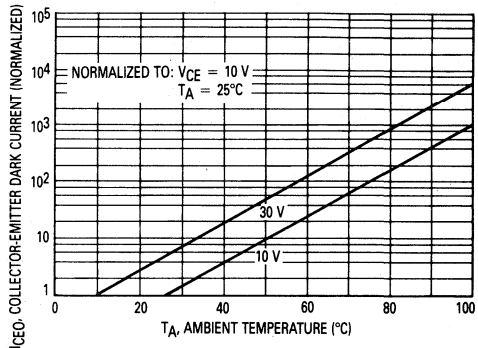

Figure 6. Collector-Emitter Dark Current versus Ambient Temperature

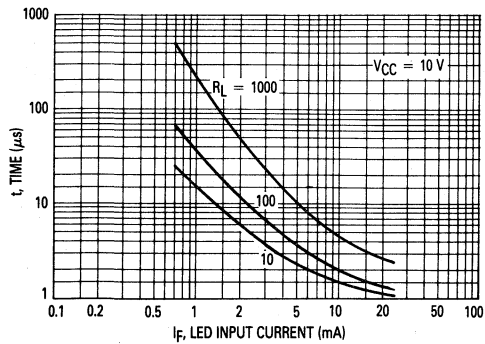

Figure 7. Turn-On Switching Times

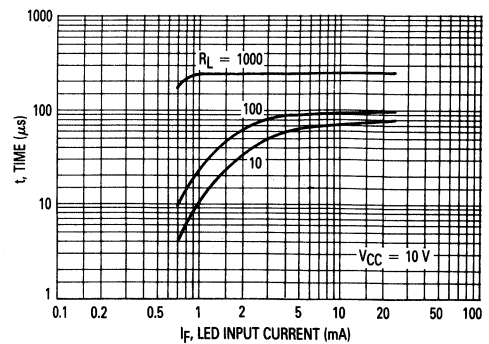

Figure 8. Turn-Off Switching Times

4N29, 4N29A, 4N30, 4N31, 4N32, 4N32A, 4N33

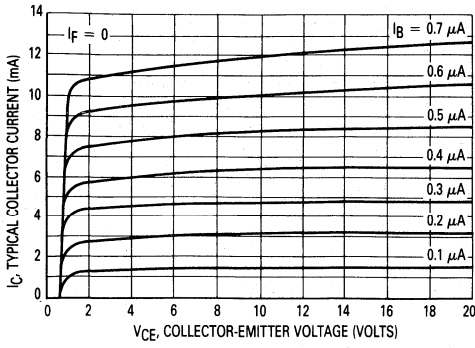

Figure 9. DC Current Gain (Detector Only)

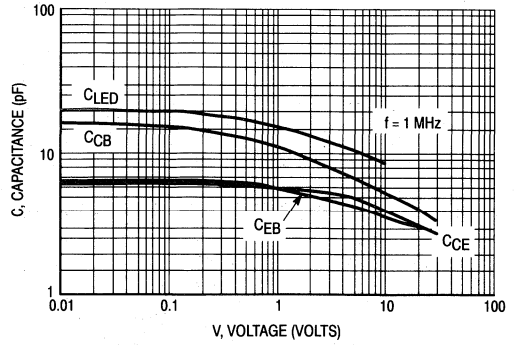

Figure 10. Capacitances versus Voltage

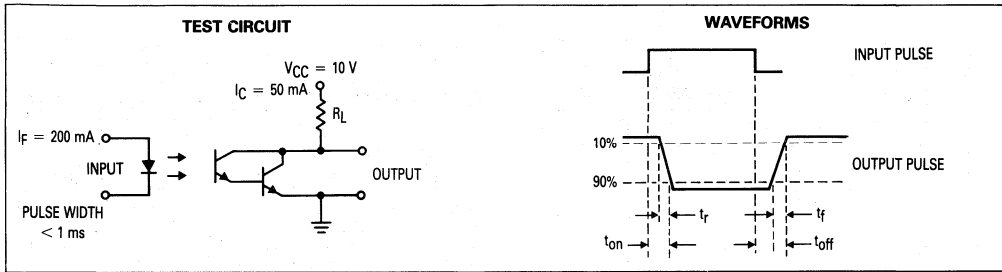

Figure 11. Switching Times

4

MOTOROLA SEMICONDUCTOR TECHNICAL DATA



6-Pin DIP Optoisolators Transistor Output

The 4N35, 4N36 and 4N37 devices consist of a gallium arsenide infrared emitting diode optically coupled to a monolithic silicon phototransistor detector.

- High Current Transfer Ratio — 100% Minimum @ Spec Conditions
- Guaranteed Switching Speeds
- Meets or Exceeds all JEDEC Registered Specifications

Applications

- General Purpose Switching Circuits
- Interfacing and coupling systems of different potentials and impedances
- Regulation Feedback Circuits
- Monitor & Detection Circuits
- Solid State Relays

MAXIMUM RATINGS ($T_A = 25^\circ\text{C}$ unless otherwise noted)

Rating	Symbol	Value	Unit
--------	--------	-------	------

INPUT LED

Reverse Voltage	V_R	6	Volts
Forward Current — Continuous	I_F	60	mA
LED Power Dissipation @ $T_A = 25^\circ\text{C}$ with Negligible Power in Output Detector Derate above 25°C	P_D	120	mW
		1.41	$\text{mW}/^\circ\text{C}$

OUTPUT TRANSISTOR

Collector-Emitter Voltage	V_{CEO}	30	Volts
Emitter-Base Voltage	V_{EBO}	7	Volts
Collector-Base Voltage	V_{CBO}	70	Volts
Collector Current — Continuous	I_C	150	mA
Detector Power Dissipation @ $T_A = 25^\circ\text{C}$ with Negligible Power in Input LED Derate above 25°C	P_D	150	mW
		1.76	$\text{mW}/^\circ\text{C}$

TOTAL DEVICE

Isolation Source Voltage (1) (Peak ac Voltage, 60 Hz, 1 sec Duration)	V_{ISO}	7500	Vac
Total Device Power Dissipation @ $T_A = 25^\circ\text{C}$ Derate above 25°C	P_D	250 2.94	mW $\text{mW}/^\circ\text{C}$
Ambient Operating Temperature Range (2)	T_A	-55 to +100	$^\circ\text{C}$
Storage Temperature Range	T_{stg}	-55 to +150	$^\circ\text{C}$
Soldering Temperature (10 sec, 1/16" from case)	T_L	260	$^\circ\text{C}$

(1) Isolation surge voltage is an internal device dielectric breakdown rating. For this test, Pins 1 and 2 are common, and Pins 4, 5 and 6 are common.

(2) Refer to Quality and Reliability Section for test information.

4N35*
4N36
4N37

[CTR = 100% Min]

*Motorola Preferred Device
STYLE 1 PLASTIC



STANDARD THRU HOLE
CASE 730A-04



"T" LEADFORM
WIDE SPACED 0.4"
CASE 730D-05



"S"/"F" LEADFORM
SURFACE MOUNT
CASE 730C-04
(STANDARD PROFILE)



CASE 730F-04
(LOW PROFILE)

SCHEMATIC

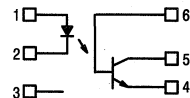

- PIN 1. LED ANODE
2. LED CATHODE
3. N.C.
4. EMITTER
5. COLLECTOR
6. BASE

4N35, 4N36, 4N37

ELECTRICAL CHARACTERISTICS (T_A = 25°C unless otherwise noted)

Characteristic	Symbol	Min	Typ	Max	Unit
----------------	--------	-----	-----	-----	------

INPUT LED

Forward Voltage (I _F = 10 mA)	T _A = 25°C T _A = -55°C T _A = 100°C	V _F	0.8 0.9 0.7	1.15 1.3 1.05	1.5 1.7 1.4	V
Reverse Leakage Current (V _R = 6 V)		I _R	—	—	10	μA
Capacitance (V = 0 V, f = 1 MHz)		C _J	—	18	—	pF

OUTPUT TRANSISTOR

Collector-Emitter Dark Current (V _{CE} = 10 V, T _A = 25°C) (V _{CE} = 30 V, T _A = 100°C)		I _{CEO}	— —	1 —	50 500	nA μA
Collector-Base Dark Current (V _{CB} = 10 V)	T _A = 25°C T _A = 100°C	I _{CBO}	— —	0.2 100	20 —	nA
Collector-Emitter Breakdown Voltage (I _C = 1 mA)		V _{(BR)CEO}	30	45	—	V
Collector-Base Breakdown Voltage (I _C = 100 μA)		V _{(BR)CBO}	70	100	—	V
Emitter-Base Breakdown Voltage (I _E = 100 μA)		V _{(BR)EBO}	7	7.8	—	V
DC Current Gain (I _C = 2 mA, V _{CE} = 5 V)		h _{FE}	—	400	—	—
Collector-Emitter Capacitance (f = 1 MHz, V _{CE} = 0)		C _{CE}	—	7	—	pF
Collector-Base Capacitance (f = 1 MHz, V _{CB} = 0)		C _{CB}	—	19	—	pF
Emitter-Base Capacitance (f = 1 MHz, V _{EB} = 0)		C _{EB}	—	9	—	pF

COUPLED

Output Collector Current (I _F = 10 mA, V _{CE} = 10 V)	T _A = 25°C T _A = -55°C T _A = 100°C	I _C	10 4 4	30 — —	— — —	mA
Collector-Emitter Saturation Voltage (I _C = 0.5 mA, I _F = 10 mA)		V _{CE(sat)}	—	0.14	0.3	V
Turn-On Time	(I _C = 2 mA, V _{CC} = 10 V, R _L = 100 Ω, Figure 11)	t _{on}	—	7.5	10	μs
Turn-Off Time		t _{off}	—	5.7	10	
Rise Time		t _r	—	3.2	—	
Fall Time		t _f	—	4.7	—	
Isolation Voltage (f = 60 Hz, t = 1 sec)		V _{ISO}	7500	—	—	Vac(pk)
Isolation Current (V _{I-O} = 3550 Vpk) (V _{I-O} = 2500 Vpk) (V _{I-O} = 1500 Vpk)	4N35 4N36 4N37	I _{ISO}	— — —	— — 8	100 100 100	μA
Isolation Resistance (V = 500 V)		R _{ISO}	10 ¹¹	—	—	Ω
Isolation Capacitance (V = 0 V, f = 1 MHz)		C _{ISO}	—	0.2	2	pF

TYPICAL CHARACTERISTICS

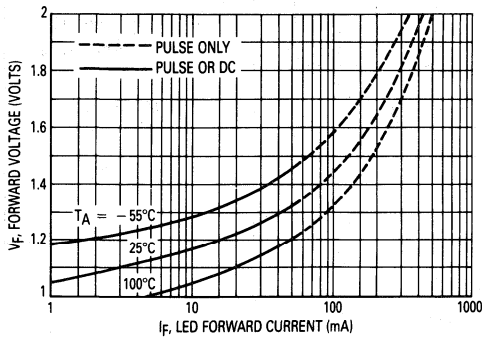

Figure 1. LED Forward Voltage versus Forward Current

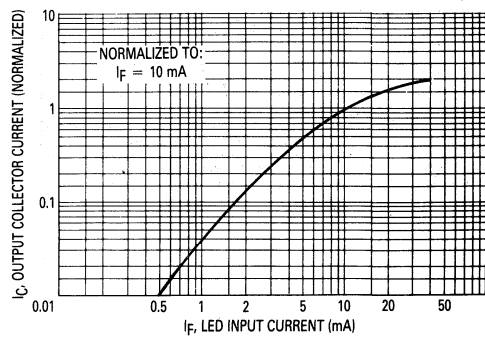

Figure 2. Output Current versus Input Current

4N35, 4N36, 4N37

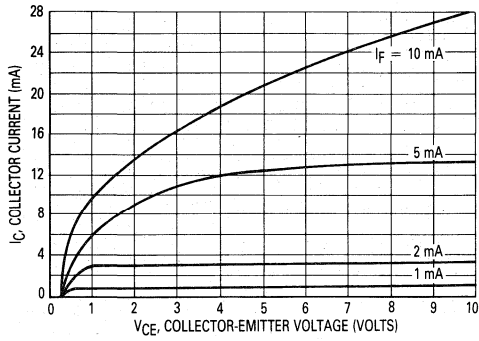

Figure 3. Collector Current versus Collector-Emitter Voltage

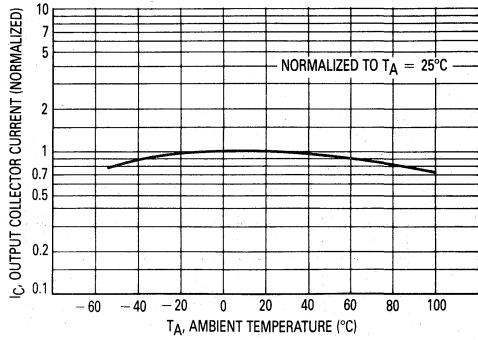

Figure 4. Output Current versus Ambient Temperature

4

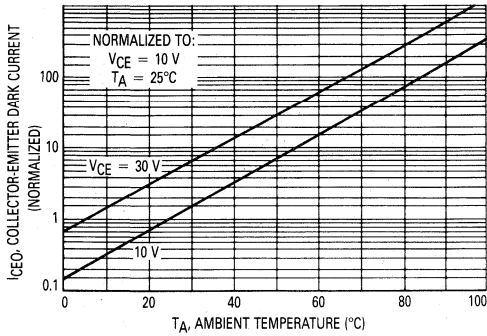

Figure 5. Dark Current versus Ambient Temperature

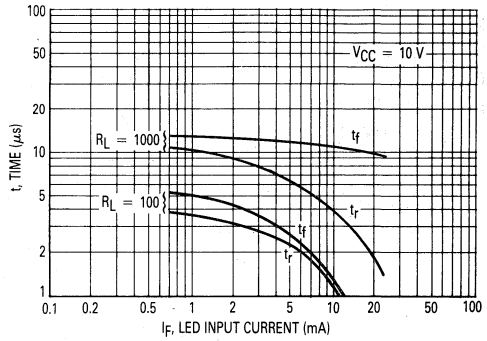

Figure 6. Rise and Fall Times

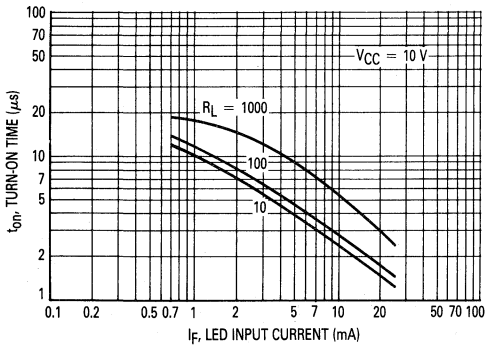

Figure 7. Turn-On Switching Times

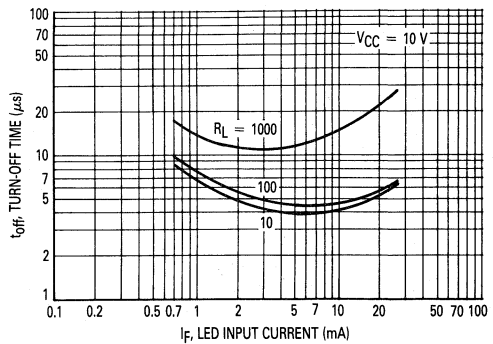

Figure 8. Turn-Off Switching Times

4N35, 4N36, 4N37

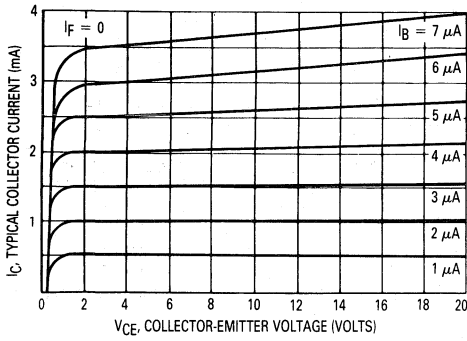

Figure 9. DC Current Gain (Detector Only)

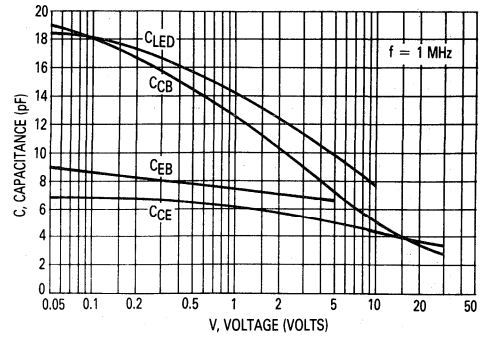

Figure 10. Capacitances versus Voltage

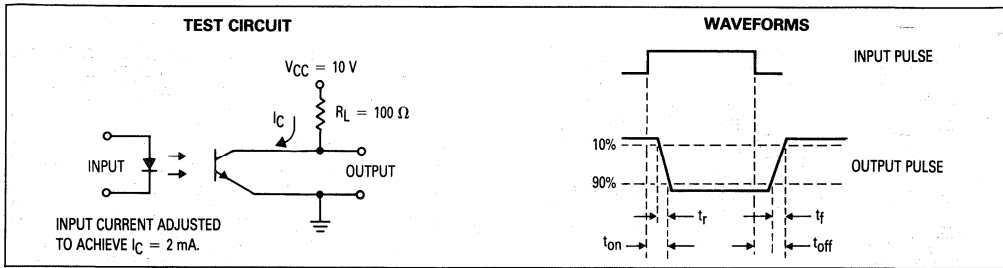

Figure 11. Switching Times

4



6-Pin DIP Optoisolators Transistor Output

The 4N38 and 4N38A devices consist of a gallium arsenide infrared emitting diode optically coupled to a monolithic silicon phototransistor detector.

- Guaranteed 80 Volt $V_{(BR)CEO}$ Minimum
- Meets or Exceeds all JEDEC Registered Specifications

Applications

- General Purpose Switching Circuits
- Interfacing and coupling systems of different potentials and impedances
- Monitor & Detection Circuits

MAXIMUM RATINGS ($T_A = 25^\circ\text{C}$ unless otherwise noted)

Rating	Symbol	Value	Unit
--------	--------	-------	------

INPUT LED

Reverse Voltage	V_R	3	Volts
Forward Current — Continuous	I_F	80	mA
Forward Current — Pk ($PW = 300 \mu\text{s}$, 2% duty cycle)	$I_F(\text{pk})$	3	A
LED Power Dissipation @ $T_A = 25^\circ\text{C}$ with Negligible Power in Output Detector Derate above 25°C	P_D	150	mW
		1.41	mW/ $^\circ\text{C}$

OUTPUT TRANSISTOR

Collector-Emitter Voltage	V_{CEO}	80	Volts
Emitter-Collector Voltage	V_{ECO}	7	Volts
Collector-Base Voltage	V_{CBO}	80	Volts
Collector Current — Continuous	I_C	100	mA
Detector Power Dissipation @ $T_A = 25^\circ\text{C}$ with Negligible Power in Input LED Derate above 25°C	P_D	150	mW
		1.76	mW/ $^\circ\text{C}$

TOTAL DEVICE

Isolation Surge Voltage (1) (Peak ac Voltage, 60 Hz, 1 sec Duration)	V_{ISO}	7500	Vac
Total Device Power Dissipation @ $T_A = 25^\circ\text{C}$ Derate above 25°C	P_D	250 2.94	mW mW/ $^\circ\text{C}$
Ambient Operating Temperature Range (3)	T_A	-55 to +100	$^\circ\text{C}$
Storage Temperature Range	T_{stg}	-55 to +150	$^\circ\text{C}$
Soldering Temperature (10 sec, 1/16" from case)	T_L	260	$^\circ\text{C}$

(1) Isolation surge voltage is an internal device dielectric breakdown rating. For this test, Pins 1 and 2 are common, and Pins 4, 5 and 6 are common.

(2) 4N38 does not require UL approval; 4N38A does. Otherwise both parts are identical. Both parts built by Motorola have UL approval.

(3) Refer to Quality and Reliability Section for test information.

4N38
4N38A

[CTR = 20% Min]

STYLE 1 PLASTIC



STANDARD THRU HOLE
 CASE 730A-04



"T" LEADFORM
 WIDE SPACED 0.4"
 CASE 730D-05



"S"/"F" LEADFORM
 SURFACE MOUNT
 CASE 730C-04
 (STANDARD PROFILE)



CASE 730F-04
 (LOW PROFILE)

SCHEMATIC

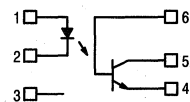

- PIN 1. LED ANODE
- 2. LED CATHODE
- 3. N.C.
- 4. EMITTER
- 5. COLLECTOR
- 6. BASE

4N38, 4N38A

ELECTRICAL CHARACTERISTICS (T_A = 25°C unless otherwise noted)

Characteristic	Symbol	Min	Typ	Max	Unit	
INPUT LED						
Forward Voltage (I _F = 10 mA)	T _A = 25°C T _A = -55°C T _A = 100°C	V _F	—	1.15	1.5	Volts
			—	1.3	—	
			—	1.05	—	
Reverse Leakage Current (V _R = 3 V)	I _R	—	—	100	μA	
Capacitance (V = 0 V, f = 1 MHz)	C _J	—	18	—	pF	

OUTPUT TRANSISTOR

Collector-Emitter Dark Current	(V _{CE} = 60 V, T _A = 25°C)	I _{CEO}	—	20	50	nA
	(V _{CE} = 60 V, T _A = 100°C)	I _{CEO}	—	6	—	μA
Collector-Base Dark Current (V _{CB} = 60 V)	I _{CBO}	—	2	20	nA	
Collector-Emitter Breakdown Voltage (I _C = 1 mA)	V _{(BR)CEO}	80	120	—	Volts	
Collector-Base Breakdown Voltage (I _C = 1 μA)	V _{(BR)CBO}	80	120	—	Volts	
Emitter-Collector Breakdown Voltage (I _E = 100 μA)	V _{(BR)ECO}	7	7.8	—	Volts	
DC Current Gain (I _C = 2 mA, V _{CE} = 5 V)	h _{FE}	—	400	—	—	
Collector-Emitter Capacitance (f = 1 MHz, V _{CE} = 0)	C _{CE}	—	8	—	pF	
Collector-Base Capacitance (f = 1 MHz, V _{CB} = 0)	C _{CB}	—	21	—	pF	
Emitter-Base Capacitance (f = 1 MHz, V _{EB} = 0)	C _{EB}	—	8	—	pF	

COUPLED

Output Collector Current (I _F = 20 mA, V _{CE} = 1 V)	I _C	4	7	—	mA
Collector-Emitter Saturation Voltage (I _C = 4 mA, I _F = 20 mA)	V _{CE(sat)}	—	—	1	Volts
Turn-On Time (I _C = 2 mA, V _{CC} = 10 V, R _L = 100 Ω, Figure 11)	t _{on}	—	5	—	μs
Turn-Off Time (I _C = 2 mA, V _{CC} = 10 V, R _L = 100 Ω, Figure 11)	t _{off}	—	4	—	μs
Rise Time (I _C = 2 mA, V _{CC} = 10 V, R _L = 100 Ω, Figure 11)	t _r	—	2	—	μs
Fall Time (I _C = 2 mA, V _{CC} = 10 V, R _L = 100 Ω, Figure 11)	t _f	—	3	—	μs
Isolation Voltage (f = 60 Hz, t = 1 sec)	V _{ISO}	7500	—	—	Vac(pk)
Isolation Resistance (V = 500 V)	R _{ISO}	10 ¹¹	—	—	Ω
Isolation Capacitance (V = 0 V, f = 1 MHz)	C _{ISO}	—	0.2	—	pF

TYPICAL CHARACTERISTICS

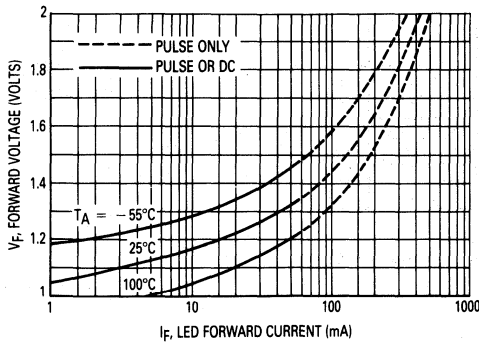

Figure 1. LED Forward Voltage versus Forward Current

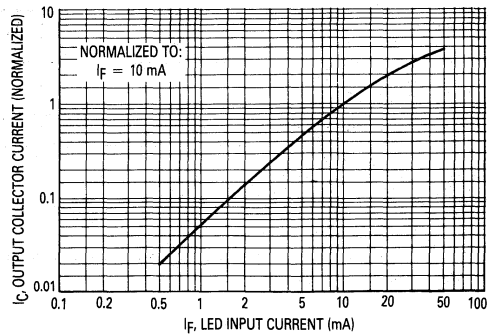

Figure 2. Output Current versus Input Current

4N38, 4N38A

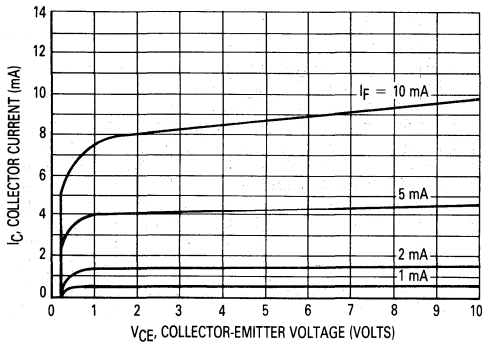

Figure 3. Collector Current versus Collector-Emitter Voltage

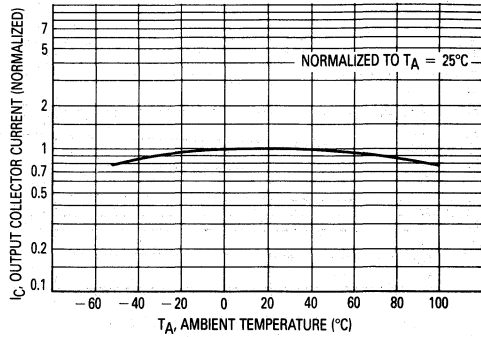

Figure 4. Output Current versus Ambient Temperature

4

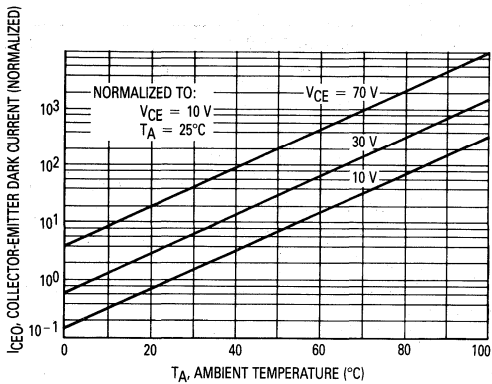

Figure 5. Dark Current versus Ambient Temperature

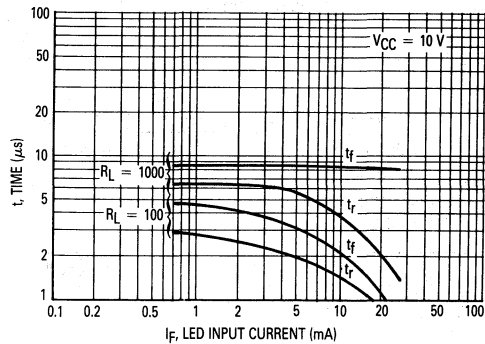

Figure 6. Rise and Fall Times

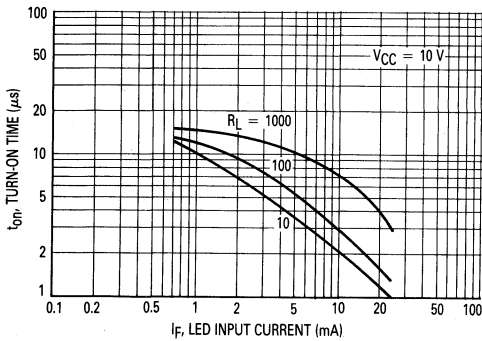

Figure 7. Turn-On Switching Times

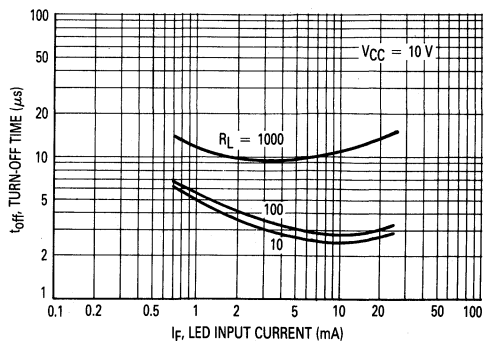

Figure 8. Turn-Off Switching Times

4N38, 4N38A

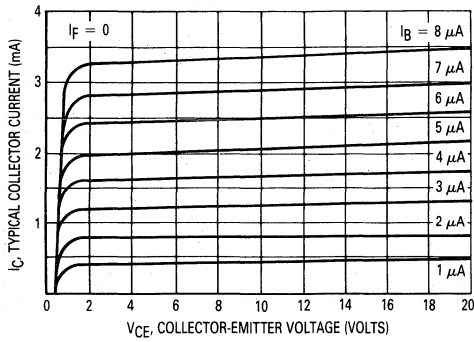

Figure 9. DC Current Gain (Detector Only)

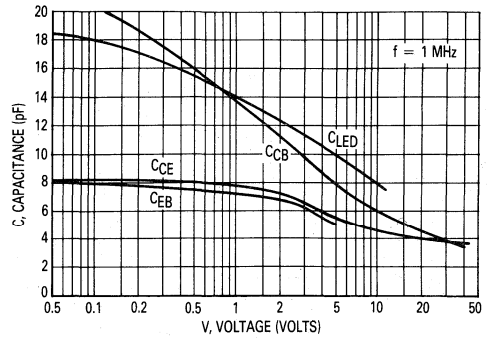

Figure 10. Capacitances versus Voltage

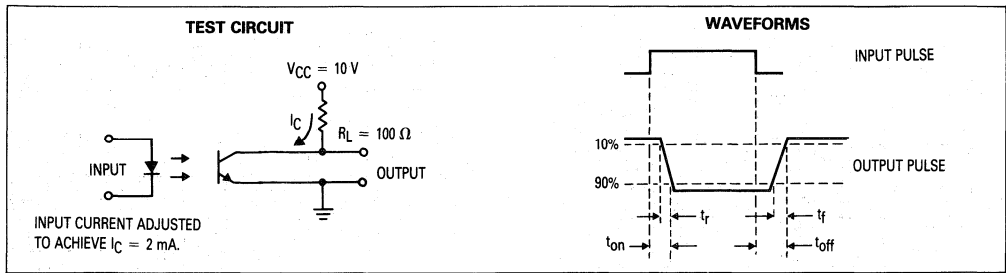

Figure 11. Switching Times

4

MOTOROLA SEMICONDUCTOR TECHNICAL DATA



6-Pin DIP Optoisolators Transistor Output

The CNY17-1, CNY17-2 and CNY17-3 devices consist of a gallium arsenide infrared emitting diode optically coupled to a monolithic silicon phototransistor detector.

- Closely Matched Current Transfer Ratio (CTR)
- Guaranteed 70 Volt $V_{(BR)CEO}$ Minimum

Applications

- Feedback Control Circuits
- Interfacing and coupling systems of different potentials and impedances
- General Purpose Switching Circuits
- Monitor and Detection Circuits

MAXIMUM RATINGS ($T_A = 25^\circ\text{C}$ unless otherwise noted)

Rating	Symbol	Value	Unit
INPUT LED			
Reverse Voltage	V_R	6	Volts
Forward Current — Continuous	I_F	60	mA
Forward Current — Pk ($PW = 1 \mu\text{s}$, 330 pps)	$I_F(\text{pk})$	1.5	A
LED Power Dissipation @ $T_A = 25^\circ\text{C}$ with Negligible Power in Output Detector Derate above 25°C	P_D	120	mW
		1.41	mW/ $^\circ\text{C}$
OUTPUT TRANSISTOR			
Collector-Emitter Voltage	V_{CEO}	70	Volts
Emitter-Base Voltage	V_{EBO}	7	Volts
Collector-Base Voltage	V_{CBO}	70	Volts
Collector Current — Continuous	I_C	100	mA
Detector Power Dissipation @ $T_A = 25^\circ\text{C}$ with Negligible Power in Input LED Derate above 25°C	P_D	150	mW
		1.76	mW/ $^\circ\text{C}$
TOTAL DEVICE			
Isolation Surge Voltage (1) (Peak ac Voltage, 60 Hz, 1 sec Duration)	V_{ISO}	7500	Vac
Total Device Power Dissipation @ $T_A = 25^\circ\text{C}$ Derate above 25°C	P_D	250 2.94	mW mW/ $^\circ\text{C}$
Ambient Operating Temperature Range (2)	T_A	-55 to +100	$^\circ\text{C}$
Storage Temperature Range	T_{stg}	-55 to +150	$^\circ\text{C}$
Soldering Temperature (10 sec, 1/16" from case)	T_L	260	$^\circ\text{C}$

(1) Isolation surge voltage is an internal device dielectric breakdown rating. For this test, Pins 1 and 2 are common, and Pins 4, 5 and 6 are common.

(2) Refer to Quality and Reliability Section for test information.

CNY17-1

[CTR = 40–80%]

CNY17-2

[CTR = 63–125%]

CNY17-3

[CTR = 100–200%]

Motorola Preferred Devices
STYLE 1 PLASTIC



STANDARD THRU HOLE
CASE 730A-04



"T" LEADFORM
WIDE SPACED 0.4"
CASE 730D-05



"S"/'F' LEADFORM
SURFACE MOUNT
CASE 730C-04
(STANDARD PROFILE)



CASE 730F-04
(LOW PROFILE)

SCHEMATIC

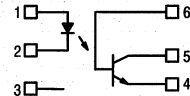

- PIN 1. LED ANODE
- LED CATHODE
- N.C.
- EMITTER
- COLLECTOR
- BASE

CNY17-1, CNY17-2, CNY17-3

ELECTRICAL CHARACTERISTICS ($T_A = 25^\circ\text{C}$ unless otherwise noted)

Characteristic	Symbol	Min	Typ	Max	Unit
INPUT LED					
Forward Voltage ($I_F = 60\text{ mA}$)	V_F	—	1.35	1.65	Volts
$T_A = 25^\circ\text{C}$		—	1.5	—	
$T_A = -55^\circ\text{C}$ $T_A = 100^\circ\text{C}$		—	1.25	—	
Reverse Leakage Current ($V_R = 6\text{ V}$)	I_R	—	—	10	μA
Capacitance ($V = 0, f = 1\text{ MHz}$)	C_J	—	18	—	pF

OUTPUT TRANSISTOR

Collector-Emitter Dark Current ($V_{CE} = 10\text{ V}, T_A = 25^\circ\text{C}$)	CNY17-1,2 CNY17-3	I_{CEO}	—	5	50	nA
($V_{CE} = 10\text{ V}, T_A = 100^\circ\text{C}$)	All devices	I_{CEO}	—	1.6	—	μA
Collector-Base Dark Current ($V_{CB} = 10\text{ V}$)		I_{CBO}	—	0.5	—	nA
Collector-Emitter Breakdown Voltage ($I_C = 1\text{ mA}$)		$V_{(BR)CEO}$	70	120	—	Volts
Collector-Base Breakdown Voltage ($I_C = 100\text{ }\mu\text{A}$)		$V_{(BR)CBO}$	70	120	—	Volts
Emitter-Base Breakdown Voltage ($I_E = 100\text{ }\mu\text{A}$)		$V_{(BR)EBO}$	7	7.8	—	Volts
DC Current Gain ($I_C = 2\text{ mA}, V_{CE} = 5\text{ V}$)		h_{FE}	—	400	—	—
Collector-Emitter Capacitance ($f = 1\text{ MHz}, V_{CE} = 0$)		C_{CE}	—	8	—	pF
Collector-Base Capacitance ($f = 1\text{ MHz}, V_{CB} = 0$)		C_{CB}	—	21	—	pF
Emitter-Base Capacitance ($f = 1\text{ MHz}, V_{EB} = 0$)		C_{EB}	—	8	—	pF

COUPLED

Output Collector Current ($I_F = 10\text{ mA}, V_{CE} = 5\text{ V}$)	CNY17-1 CNY17-2 CNY17-3	I_C	4 6.3 10	6 10 15	8 12.5 20	mA
Collector-Emitter Saturation Voltage ($I_C = 2.5\text{ mA}, I_F = 10\text{ mA}$)		$V_{CE(sat)}$	—	0.18	0.4	Volts
Delay Time ($I_F = 10\text{ mA}, V_{CC} = 5\text{ V}, R_L = 75\text{ }\Omega$, Figure 11)		t_d	—	1.6	5.6	μs
Rise Time ($I_F = 10\text{ mA}, V_{CC} = 5\text{ V}, R_L = 75\text{ }\Omega$, Figure 11)		t_r	—	1.6	4	μs
Storage Time ($I_F = 10\text{ mA}, V_{CC} = 5\text{ V}, R_L = 75\text{ }\Omega$, Figure 11)		t_s	—	0.7	4.1	μs
Fall Time ($I_F = 10\text{ mA}, V_{CC} = 5\text{ V}, R_L = 75\text{ }\Omega$, Figure 11)		t_f	—	2.3	3.5	μs
Delay Time ($I_F = 20\text{ mA}, V_{CC} = 5\text{ V}, R_L = 1\text{ k}\Omega$, Figure 11)	CNY17-1	t_d	—	1.2	5.5	μs
($I_F = 10\text{ mA}, V_{CC} = 5\text{ V}, R_L = 1\text{ k}\Omega$, Figure 11)	CNY17-2,3		—	1.8	8	
Rise Time ($I_F = 20\text{ mA}, V_{CC} = 5\text{ V}, R_L = 1\text{ k}\Omega$, Figure 11)	CNY17-1	t_r	—	3.3	4	μs
($I_F = 10\text{ mA}, V_{CC} = 5\text{ V}, R_L = 1\text{ k}\Omega$, Figure 11)	CNY17-2,3		—	5	6	
Storage Time ($I_F = 20\text{ mA}, V_{CC} = 5\text{ V}, R_L = 1\text{ k}\Omega$, Figure 11)	CNY17-1	t_s	—	4.4	34	μs
($I_F = 10\text{ mA}, V_{CC} = 5\text{ V}, R_L = 1\text{ k}\Omega$, Figure 11)	CNY17-2,3		—	2, 7	39	
Fall Time ($I_F = 20\text{ mA}, V_{CC} = 5\text{ V}, R_L = 1\text{ k}\Omega$, Figure 11)	CNY17-1	t_f	—	9.7	20	μs
($I_F = 10\text{ mA}, V_{CC} = 5\text{ V}, R_L = 1\text{ k}\Omega$, Figure 11)	CNY17-2,3		—	9.4, 20	24	
Isolation Voltage ($f = 60\text{ Hz}, t = 1\text{ sec}$)		V_{ISO}	7500	—	—	Vac(pk)
Isolation Resistance ($V = 500\text{ V}$)		R_{ISO}	10^{11}	—	—	Ω
Isolation Capacitance ($V = 0, f = 1\text{ MHz}$)		C_{ISO}	—	0.2	0.5	pF

CNY17-1, CNY17-2, CNY17-3

TYPICAL CHARACTERISTICS

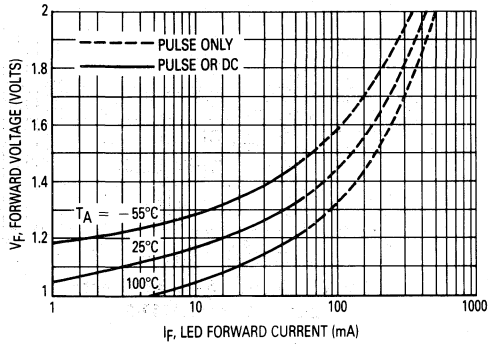

Figure 1. LED Forward Voltage versus Forward Current

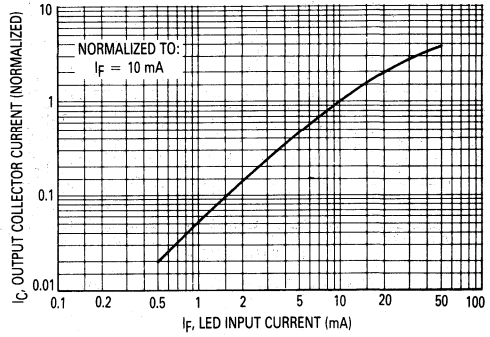

Figure 2. Output Current versus Input Current

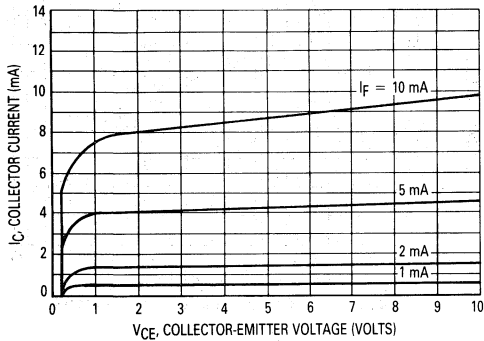

Figure 3. Collector Current versus Collector-Emitter Voltage

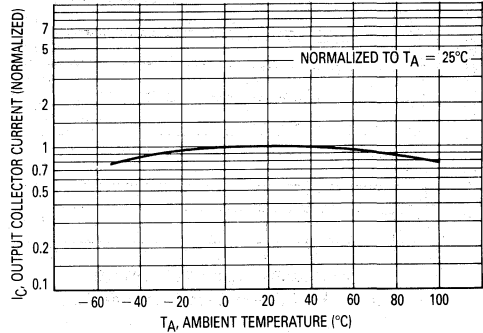

Figure 4. Output Current versus Ambient Temperature

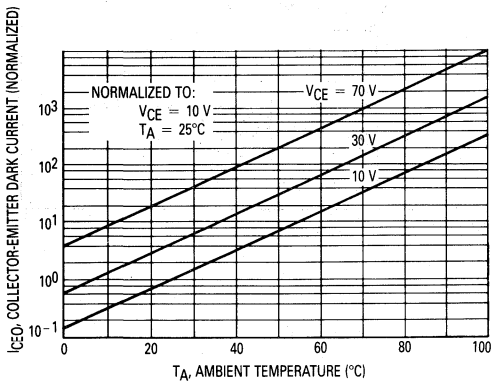

Figure 5. Dark Current versus Ambient Temperature

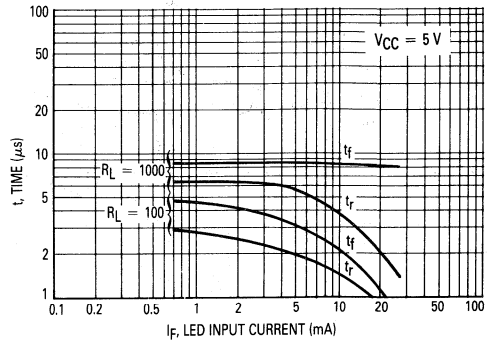

Figure 6. Rise and Fall Times CNY17-1 and CNY17-2

CNY17-1, CNY17-2, CNY17-3

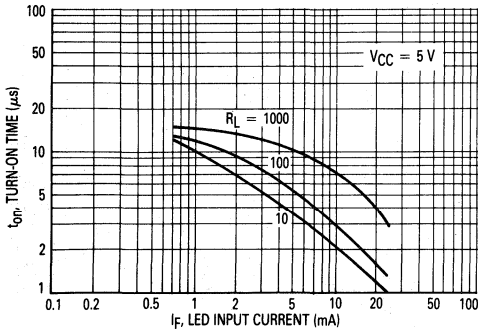

Figure 7. Turn-On Switching Times

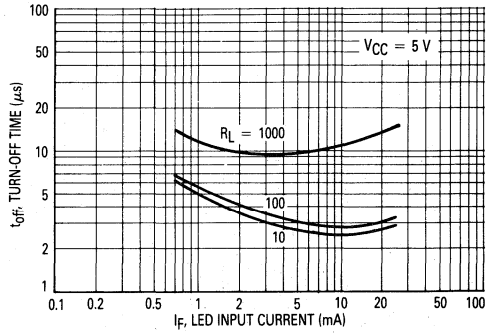

Figure 8. Turn-Off Switching Times
CNY17-1 and CNY17-2

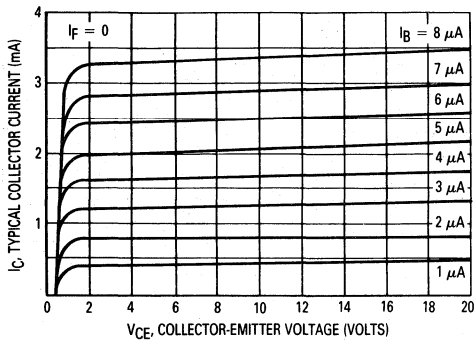

Figure 9. DC Current Gain (Detector Only)

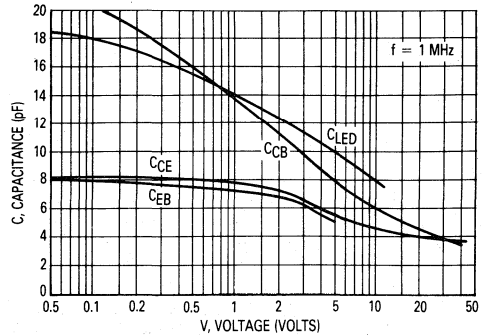

Figure 10. Capacitances versus Voltage

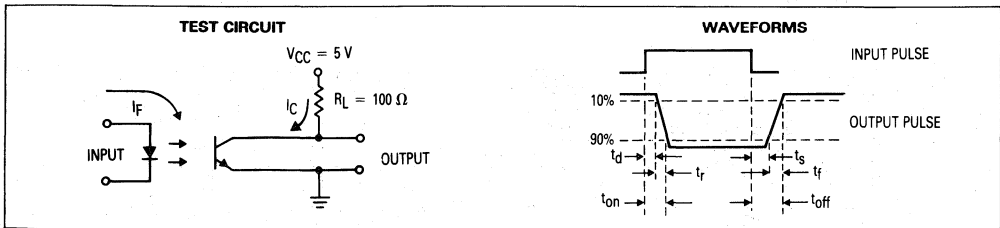

Figure 11. Switching Times

MOTOROLA
SEMICONDUCTOR
TECHNICAL DATA



6-Pin DIP Optoisolators
Transistor Output

The H11A1 thru H11A5 devices consist of a gallium arsenide infrared emitting diode optically coupled to a monolithic silicon phototransistor detector.

- Current Transfer Ratios (CTR) Ranging from 10% to 50%
- Economical

Applications

- General Purpose Switching Circuits
- Interfacing and coupling systems of different potentials and impedances
- Monitor and Detection Circuits

MAXIMUM RATINGS ($T_A = 25^\circ\text{C}$ unless otherwise noted)

Rating	Symbol	Value	Unit
--------	--------	-------	------

INPUT LED

Reverse Voltage	V_R	3	Volts
Forward Current — Continuous	I_F	60	mA
LED Power Dissipation @ $T_A = 25^\circ\text{C}$ with Negligible Power in Output Detector Derate above 25°C	P_D	120	mW
		1.41	$\text{mW}/^\circ\text{C}$

OUTPUT TRANSISTOR

Collector-Emitter Voltage	V_{CEO}	30	Volts
Emitter-Collector Voltage	V_{ECO}	7	Volts
Collector-Base Voltage	V_{CBO}	70	Volts
Collector Current — Continuous	I_C	150	mA
Detector Power Dissipation @ $T_A = 25^\circ\text{C}$ with Negligible Power in Input LED Derate above 25°C	P_D	150	mW
		1.76	$\text{mW}/^\circ\text{C}$

TOTAL DEVICE

Isolation Surge Voltage (1) (Peak ac Voltage, 60 Hz, 1 sec Duration)	V_{ISO}	7500	Vac
Total Device Power Dissipation @ $T_A = 25^\circ\text{C}$ Derate above 25°C	P_D	250 2.94	mW $\text{mW}/^\circ\text{C}$
Ambient Operating Temperature Range (2)	T_A	-55 to +100	$^\circ\text{C}$
Storage Temperature Range	T_{stg}	-55 to +150	$^\circ\text{C}$
Soldering Temperature (10 sec, 1/16" from case)	T_L	260	$^\circ\text{C}$

(1) Isolation surge voltage is an internal device dielectric breakdown rating. For this test, Pins 1 and 2 are common, and Pins 4, 5 and 6 are common.

(2) Refer to Quality and Reliability Section for test information.

H11A1
thru
H11A5

STYLE 1 PLASTIC



STANDARD THRU HOLE
CASE 730A-04



"T" LEADFORM
WIDE SPACED 0.4"
CASE 730D-05



"S"/"F" LEADFORM
SURFACE MOUNT
CASE 730C-04
(STANDARD PROFILE)



CASE 730F-04
(Low PROFILE)

4

SCHEMATIC

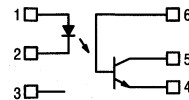

- PIN 1. LED ANODE
2. LED CATHODE
3. N.C.
4. EMITTER
5. COLLECTOR
6. BASE

H11A1 thru H11A5

ELECTRICAL CHARACTERISTICS ($T_A = 25^\circ\text{C}$ unless otherwise noted)

Characteristic	Symbol	Min	Typ	Max	Unit
INPUT LED					
Forward Voltage ($I_F = 10\text{ mA}$, $T_A = 25^\circ\text{C}$) $T_A = -55^\circ\text{C}$ $T_A = 100^\circ\text{C}$	V_F	—	1.15 1.3 1.05	1.5	Volts
Reverse Leakage Current ($V_R = 3\text{ V}$)	I_R	—	0.01	10	μA
Capacitance ($V = 0\text{ V}$, $f = 1\text{ MHz}$)	C_J	—	18	—	pF

OUTPUT TRANSISTOR

Collector-Emitter Dark Current ($V_{CE} = 10\text{ V}$) $T_A = 25^\circ\text{C}$ $T_A = 100^\circ\text{C}$	I_{CEO}	—	1 1	50	nA μA
Collector-Base Dark Current ($V_{CB} = 10\text{ V}$) $T_A = 25^\circ\text{C}$ $T_A = 100^\circ\text{C}$	I_{CBO}	—	0.2 100	20	nA
Collector-Emitter Breakdown Voltage ($I_C = 10\text{ mA}$)	$V_{(BR)CEO}$	30	45	—	Volts
Collector-Base Breakdown Voltage ($I_C = 100\text{ }\mu\text{A}$)	$V_{(BR)CBO}$	70	100	—	Volts
Emitter-Collector Breakdown Voltage ($I_E = 100\text{ }\mu\text{A}$)	$V_{(BR)ECO}$	7	7.8	—	Volts
DC Current Gain ($I_C = 5\text{ mA}$, $V_{CE} = 5\text{ V}$)	h_{FE}	—	500	—	—
Collector-Emitter Capacitance ($f = 1\text{ MHz}$, $V_{CE} = 0\text{ V}$)	C_{CE}	—	7	—	pF
Collector-Base Capacitance ($f = 1\text{ MHz}$, $V_{CB} = 0\text{ V}$)	C_{CB}	—	19	—	pF
Emitter-Base Capacitance ($f = 1\text{ MHz}$, $V_{EB} = 0\text{ V}$)	C_{EB}	—	9	—	pF

COUPLED

Output Collector Current ($I_F = 10\text{ mA}$, $V_{CE} = 10\text{ V}$) H11A1 H11A2,3 H11A4 H11A5	I_C	5 2 1 3	12 7 5 9	—	mA
Collector-Emitter Saturation Voltage ($I_C = 0.5\text{ mA}$, $I_F = 10\text{ mA}$)	$V_{CE(sat)}$	—	0.1	0.4	Volts
Turn-On Time ($I_F = 10\text{ mA}$, $V_{CC} = 10\text{ V}$, $R_L = 100\text{ }\Omega$, Figure 11)	t_{on}	—	2.8	—	μs
Turn-Off Time ($I_F = 10\text{ mA}$, $V_{CC} = 10\text{ V}$, $R_L = 100\text{ }\Omega$, Figure 11)	t_{off}	—	4.5	—	μs
Rise Time ($I_F = 10\text{ mA}$, $V_{CC} = 10\text{ V}$, $R_L = 100\text{ }\Omega$, Figure 11)	t_r	—	1.2	—	μs
Fall Time ($I_F = 10\text{ mA}$, $V_{CC} = 10\text{ V}$, $R_L = 100\text{ }\Omega$, Figure 11)	t_f	—	1.3	—	μs
Isolation Voltage ($f = 60\text{ Hz}$, $t = 1\text{ sec}$)	V_{ISO}	7500	—	—	Vac(pk)
Isolation Resistance ($V = 500\text{ V}$)	R_{ISO}	10^{11}	—	—	Ω
Isolation Capacitance ($V = 0\text{ V}$, $f = 1\text{ MHz}$)	C_{ISO}	—	0.2	—	pF

TYPICAL CHARACTERISTICS

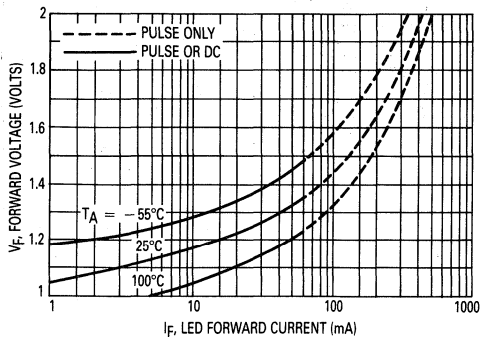

Figure 1. LED Forward Voltage versus Forward Current

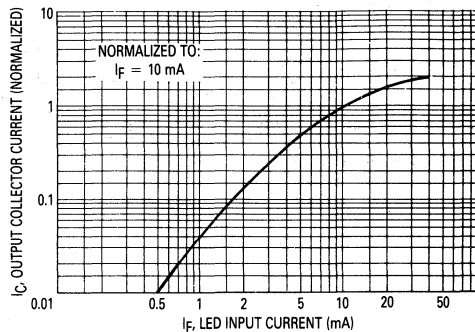

Figure 2. Output Current versus Input Current

H11A1 thru H11A5

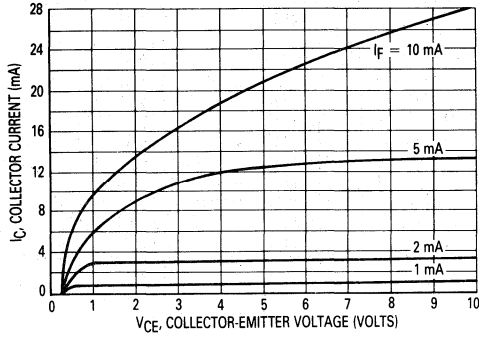

Figure 3. Collector Current versus Collector-Emitter Voltage

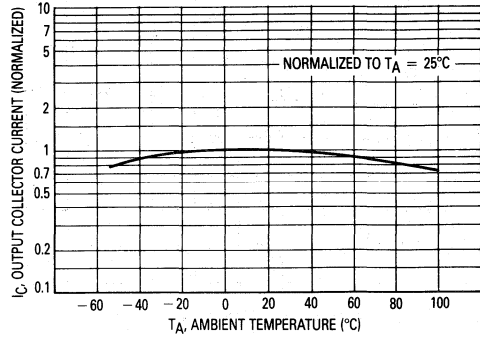

Figure 4. Output Current versus Ambient Temperature

4

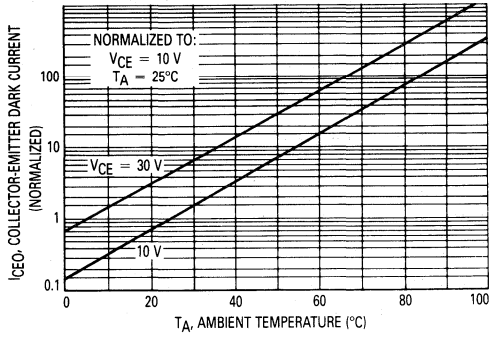

Figure 5. Dark Current versus Ambient Temperature

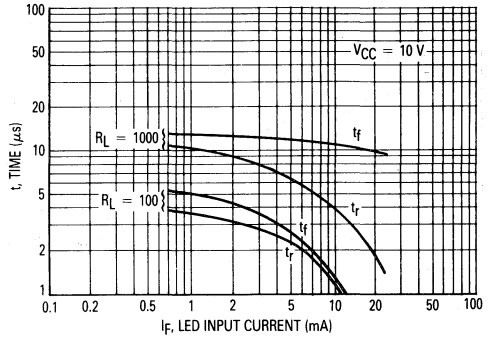

Figure 6. Rise and Fall Times

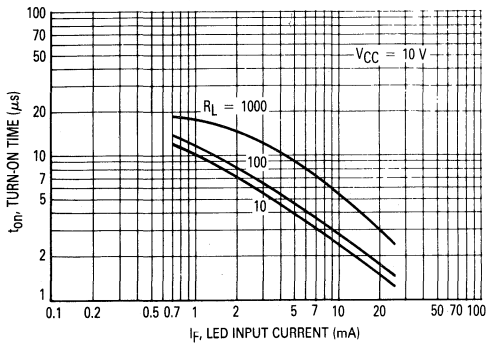

Figure 7. Turn-On Switching Times

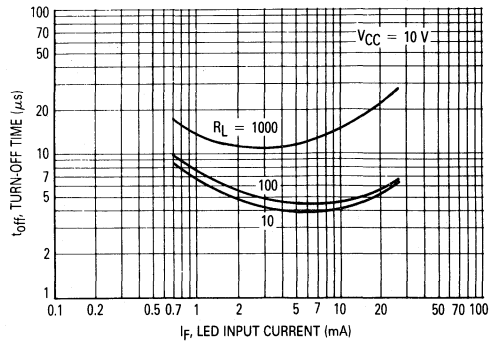

Figure 8. Turn-Off Switching Times

H11A1 thru H11A5

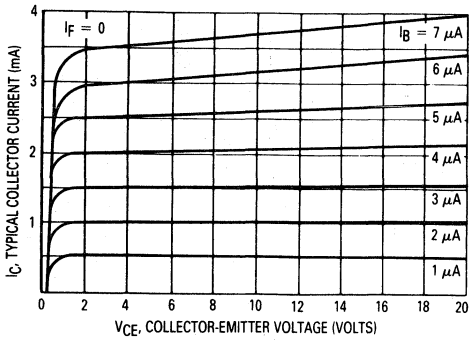

Figure 9. DC Current Gain (Detector Only)

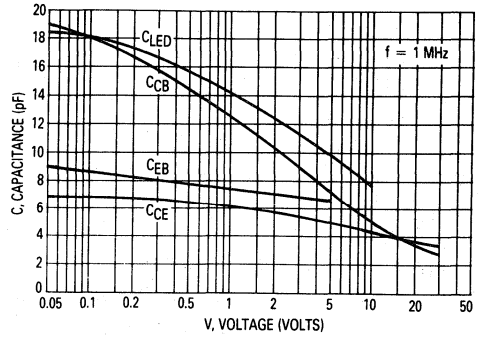

Figure 10. Capacitances versus Voltage

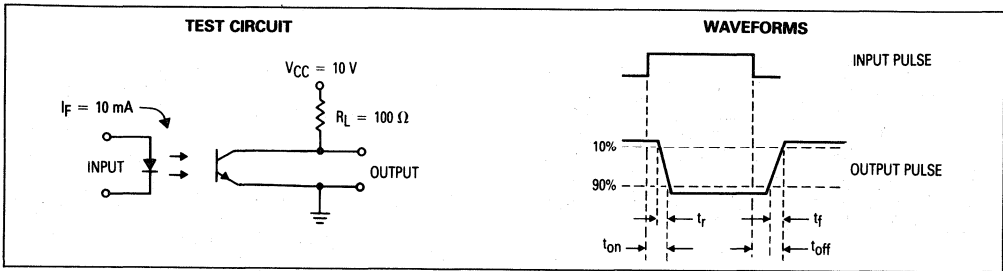
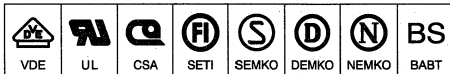

Figure 11. Switching Times

4

**MOTOROLA
SEMICONDUCTOR
TECHNICAL DATA**



6-Pin DIP Optoisolators AC Input/Transistor Output

The H11AA1, H11AA2, H11AA3, H11AA4 devices consist of a two Gallium-Arsenide infrared emitting diodes connected in inverse parallel, optically coupled to a monolithic silicon phototransistor detector.

- Built-In Protection for Reverse Polarity

Applications

- Detecting or Monitoring ac Signals
- AC Line/Digital Logic Isolation
- Programmable Controllers
- Interfacing and coupling systems of different potentials and impedances
- AC/DC — Input Modules

MAXIMUM RATINGS (T_A = 25°C unless otherwise noted)

Rating	Symbol	Value	Unit
--------	--------	-------	------

INPUT LED

Forward Current — Continuous (RMS)	I _F	60	mA
LED Power Dissipation @ T _A = 25°C with Negligible Power in Output Detector Derate above 25°C	P _D	120 1.41	mW mW/°C

OUTPUT TRANSISTOR

Collector-Emitter Voltage	V _{CEO}	30	Volts
Emitter-Base Voltage	V _{EBO}	5	Volts
Collector-Base Voltage	V _{CB0}	70	Volts
Collector Current — Continuous	I _C	150	mA
Detector Power Dissipation @ T _A = 25°C with Negligible Power in Input LEDs Derate above 25°C	P _D	150 1.76	mW mW/°C

TOTAL DEVICE

Isolation Surge Voltage (1) (Peak ac Voltage, 60 Hz, 1 sec Duration)	V _{ISO}	7500	Vac
Total Device Power Dissipation @ T _A = 25°C Derate above 25°C	P _D	250 2.94	mW mW/°C
Ambient Operating Temperature Range (2)	T _A	-55 to +100	°C
Storage Temperature Range	T _{stg}	-55 to +150	°C
Soldering Temperature (10 sec, 1/16" from case)	T _L	260	°C

(1) Isolation surge voltage is an internal device dielectric breakdown rating. For this test, Pins 1 and 2 are common, and Pins 4, 5 and 6 are common.

(2) Refer to Quality and Reliability Section for test information.

H11AA1*

[CTR = 20% Min]

H11AA2

[CTR = 10% Min]

H11AA3

[CTR = 50% Min]

H11AA4*

[CTR = 100% Min]

*Motorola Preferred Devices
STYLE 8 PLASTIC



STANDARD THRU HOLE
CASE 730A-04



"T" LEADFORM
WIDE SPACED 0.4"
CASE 730D-05



"S"/"F" LEADFORM
SURFACE MOUNT
CASE 730C-04
(STANDARD PROFILE)



CASE 730F-04
(LOW PROFILE)

SCHEMATIC

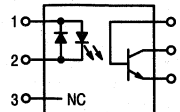

- PIN 1. INPUT LED
- 2. INPUT LED
- 3. NO CONNECTION
- 4. EMITTER
- 5. COLLECTOR
- 6. BASE

H11AA1 thru H11AA4

ELECTRICAL CHARACTERISTICS ($T_A = 25^\circ\text{C}$ unless otherwise noted)

Characteristic	Symbol	Min	Typ	Max	Unit
----------------	--------	-----	-----	-----	------

INPUT LEDS

Forward Voltage ($I_F = 10\text{ mA}$, either direction)	H11AA1,3,4	V_F	—	1.15	1.5	Volts
	H11AA2		—	1.15	1.8	
	$T_A = -55^\circ\text{C}$ All devices		—	1.3	—	
	$T_A = 100^\circ\text{C}$ All devices		—	1.05	—	
Capacitance ($V = 0\text{ V}$, $f = 1\text{ MHz}$)		C_J	—	20	—	pF

OUTPUT TRANSISTOR

Collector-Emitter Dark Current ($V_{CE} = 10\text{ V}$)	H11AA1,3,4	I_{CEO}	—	1	100	nA
	H11AA2		—	1	200	nA
	$T_A = 100^\circ\text{C}$ All devices		—	1	—	μA
Collector-Base Dark Current ($V_{CB} = 10\text{ V}$)		I_{CBO}	—	0.2	—	nA
Collector-Emitter Breakdown Voltage ($I_C = 10\text{ mA}$)		$V_{(BR)CEO}$	30	45	—	Volts
Collector-Base Breakdown Voltage ($I_C = 100\text{ }\mu\text{A}$)		$V_{(BR)CBO}$	70	100	—	Volts
Emitter-Collector Breakdown Voltage ($I_E = 100\text{ }\mu\text{A}$)		$V_{(BR)ECO}$	5	7.8	—	Volts
DC Current Gain ($I_C = 2\text{ mA}$, $V_{CE} = 5\text{ V}$)		h_{FE}	—	500	—	—
Collector-Emitter Capacitance ($f = 1\text{ MHz}$, $V_{CE} = 0\text{ V}$)		C_{CE}	—	1.7	—	pF
Collector-Base Capacitance ($f = 1\text{ MHz}$, $V_{CB} = 0\text{ V}$)		C_{CB}	—	20	—	pF
Emitter-Base Capacitance ($f = 1\text{ MHz}$, $V_{EB} = 0\text{ V}$)		C_{EB}	—	10	—	pF

COUPLED

Output Collector Current ($I_F = \pm 10\text{ mA}$, $V_{CE} = 10\text{ V}$)	H11AA1	I_C	2	5	—	mA
	H11AA2		1	2	—	
	H11AA3		5	10	—	
	H11AA4		10	15	—	
Output Collector Current Symmetry (Note 1) (I_C at $I_F = +10\text{ mA}$, $V_{CE} = 10\text{ V}$) (I_C at $I_F = -10\text{ mA}$, $V_{CE} = 10\text{ V}$)	H11AA1,3,4	—	0.33	—	3	—
Collector-Emitter Saturation Voltage ($I_C = 0.5\text{ mA}$, $I_F = \pm 10\text{ mA}$)		$V_{CE(sat)}$	—	0.1	0.4	Volts
Isolation Voltage ($f = 60\text{ Hz}$, $t = 1\text{ sec}$)		V_{ISO}	7500	—	—	Vac(pk)
Isolation Resistance ($V = 500\text{ V}$)		R_{ISO}	10^{11}	—	—	Ω
Isolation Capacitance ($V = 0\text{ V}$, $f = 1\text{ MHz}$)		C_{ISO}	—	0.2	—	pF

Note 1. This specification guarantees that the higher of the two I_C readings will be no more than 3 times the lower at $I_F = 10\text{ mA}$.

TYPICAL CHARACTERISTICS

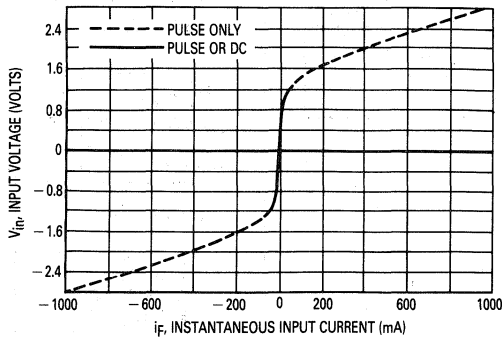

Figure 1. Input Voltage versus Input Current

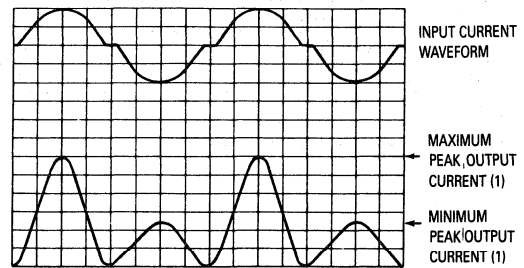

Figure 2. Output Characteristics

H11AA1 thru H11AA4

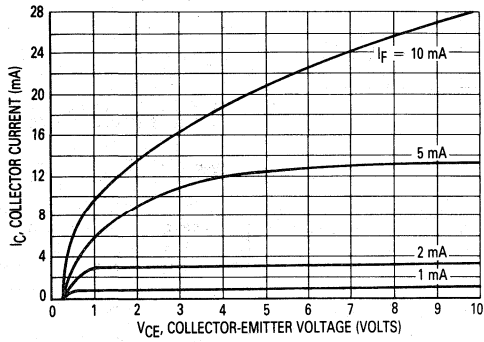

Figure 3. Collector Current versus Collector-Emitter Voltage

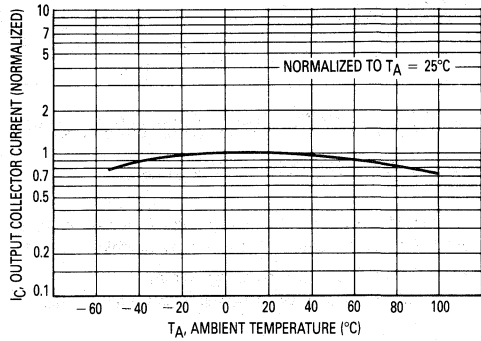

Figure 4. Output Current versus Ambient Temperature

4

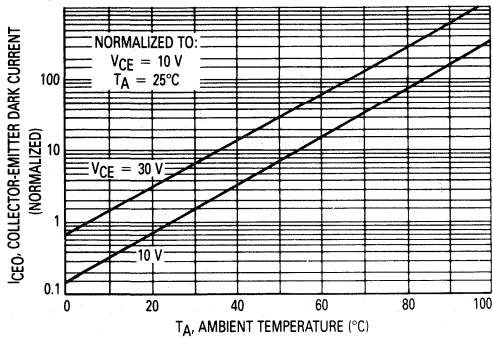

Figure 5. Dark Current versus Ambient Temperature

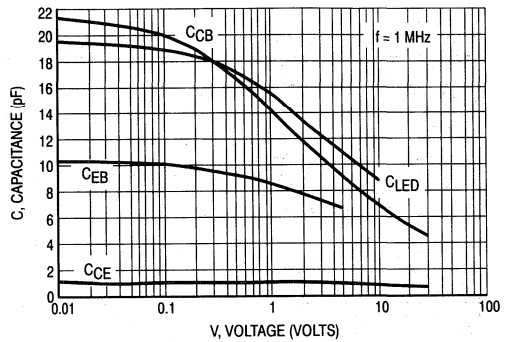

Figure 6. Capacitances versus Voltage



6-Pin DIP Optoisolators Transistor Output

The H11AV1,A, H11AV2,A and H11AV3,A devices consist of a gallium arsenide infrared emitting diode optically coupled to a monolithic silicon phototransistor detector.

- Guaranteed 70 Volt $V_{(BR)CEO}$ Minimum
- 'A' Suffix for 0.400" Wide Spacing Same as 'T' Suffix for this Series

Applications

- General Purpose Switching Circuits
- Interfacing and coupling systems of different potentials and impedances
- Monitor and Detection Circuits
- Regulation and Feedback Circuits
- Solid State Relays

MAXIMUM RATINGS ($T_A = 25^\circ\text{C}$ unless otherwise noted)

Rating	Symbol	Value	Unit
INPUT LED			
Reverse Voltage	V_R	6	Volts
Forward Current — Continuous	I_F	60	mA
LED Power Dissipation @ $T_A = 25^\circ\text{C}$ with Negligible Power in Output Detector Derate above 25°C	P_D	120	mW
		1.41	mW/ $^\circ\text{C}$

OUTPUT TRANSISTOR

Collector-Emitter Voltage	V_{CEO}	70	Volts
Emitter-Base Voltage	V_{EBO}	7	Volts
Collector-Base Voltage	V_{CBO}	70	Volts
Collector Current — Continuous	I_C	150	mA
Detector Power Dissipation @ $T_A = 25^\circ\text{C}$ with Negligible Power in Input LED Derate above 25°C	P_D	150	mW
		1.76	mW/ $^\circ\text{C}$

TOTAL DEVICE

Isolation Surge Voltage (1) (Peak ac Voltage, 60 Hz, 1 sec Duration)	V_{ISO}	7500	Vac
Total Device Power Dissipation @ $T_A = 25^\circ\text{C}$ Derate above 25°C	P_D	250 2.94	mW mW/ $^\circ\text{C}$
Ambient Operating Temperature Range (2)	T_A	-55 to +100	$^\circ\text{C}$
Storage Temperature Range	T_{stg}	-55 to +150	$^\circ\text{C}$
Soldering Temperature (10 sec, 1/16" from case)	T_L	260	$^\circ\text{C}$

(1) Isolation surge voltage is an internal device dielectric breakdown rating. For this test, Pins 1 and 2 are common, and Pins 4, 5 and 6 are common.

(2) Refer to Quality and Reliability Section for test information.

H11AV1,A*
 [CTR = 100% Min]
H11AV2,A
 [CTR = 50% Min]
H11AV3,A
 [CTR = 20% Min]
 *Motorola Preferred Devices
STYLE 1 PLASTIC



**STANDARD THRU HOLE
 CASE 730A-04**



**"T" LEADFORM
 WIDE SPACED 0.4"
 CASE 730D-05**



**"S"/"F" LEADFORM
 SURFACE MOUNT
 CASE 730C-04
 (STANDARD PROFILE)**



**CASE 730F-04
 (LOW PROFILE)**

SCHEMATIC

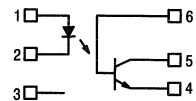

- PIN 1. LED ANODE
- 2. LED CATHODE
- 3. N.C.
- 4. EMITTER
- 5. COLLECTOR
- 6. BASE

H11AV1, H11AV1A, H11AV2, H11AV2A, H11AV3, H11AV3A

ELECTRICAL CHARACTERISTICS ($T_A = 25^\circ\text{C}$ unless otherwise noted)

Characteristic	Symbol	Min	Typ	Max	Unit
INPUT LED					
Forward Voltage ($I_F = 10\text{ mA}$)	V_F	$T_A = 25^\circ\text{C}$ 0.8	1.15	1.5	Volts
		$T_A = -55^\circ\text{C}$ 0.9	1.3	1.7	
		$T_A = 100^\circ\text{C}$ 0.7	1.05	1.4	
Reverse Leakage Current ($V_R = 6\text{ V}$)	I_R	—	—	10	μA
Capacitance ($V = 0\text{ V}$, $f = 1\text{ MHz}$)	C_J	—	18	—	pF

OUTPUT TRANSISTOR

Collector-Emitter Dark Current ($V_{CE} = 10\text{ V}$)	I_{CEO}	—	5	50	nA
Collector-Base Dark Current ($V_{CB} = 10\text{ V}$)	I_{CBO}	—	0.5	—	nA
Collector-Emitter Breakdown Voltage ($I_C = 1\text{ mA}$)	$V_{(BR)CEO}$	70	100	—	Volts
Collector-Base Breakdown Voltage ($I_C = 100\ \mu\text{A}$)	$V_{(BR)CBO}$	70	100	—	Volts
Emitter-Collector Breakdown Voltage ($I_E = 100\ \mu\text{A}$)	$V_{(BR)ECO}$	7	8	—	Volts
DC Current Gain ($I_C = 2\text{ mA}$, $V_{CE} = 10\text{ V}$)	h_{FE}	—	500	—	—
Collector-Emitter Capacitance ($f = 1\text{ MHz}$, $V_{CE} = 10\text{ V}$)	C_{CE}	—	4.5	—	pF

COUPLED

Output Collector Current ($I_F = 10\text{ mA}$, $V_{CE} = 10\text{ V}$) H11AV1, H11AV1A H11AV2, H11AV2A H11AV3, H11AV3A	I_C	10 5 2	15 10 7	30 — —	mA
Collector-Emitter Saturation Voltage ($I_C = 2\text{ mA}$, $I_F = 20\text{ mA}$)	$V_{CE(sat)}$	—	0.15	0.4	Volts
Turn-On Time ($I_C = 2\text{ mA}$, $V_{CC} = 10\text{ V}$, $R_L = 100\ \Omega$, Figure 11)	t_{on}	—	5	15	μs
Turn-Off Time ($I_C = 2\text{ mA}$, $V_{CC} = 10\text{ V}$, $R_L = 100\ \Omega$, Figure 11)	t_{off}	—	4	15	μs
Isolation Voltage ($f = 60\text{ Hz}$, $t = 1\text{ sec}$)	V_{ISO}	7500	—	—	Vac(pk)
Isolation Resistance ($V = 500\text{ V}$)	R_{ISO}	10^{11}	—	—	Ω
Isolation Capacitance ($V = 0\text{ V}$, $f = 1\text{ MHz}$)	C_{ISO}	—	0.2	0.5	pF

4

TYPICAL CHARACTERISTICS

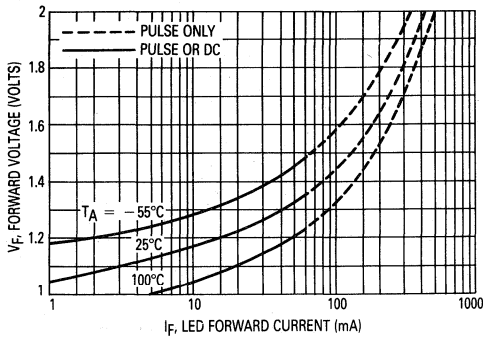

Figure 1. LED Forward Voltage versus Forward Current

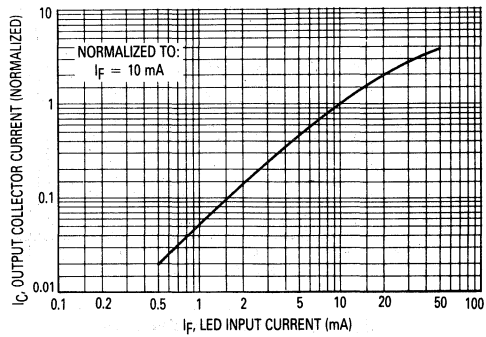

Figure 2. Output Current versus Input Current

H11AV1, H11AV1A, H11AV2, H11AV2A, H11AV3, H11AV3A

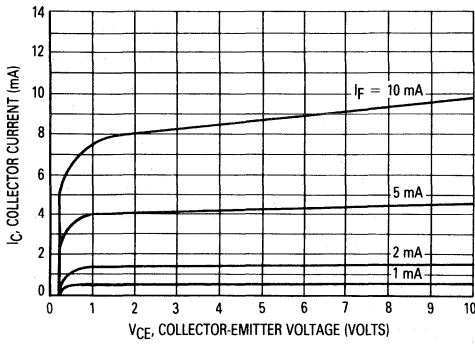

Figure 3. Collector Current versus Collector-Emitter Voltage

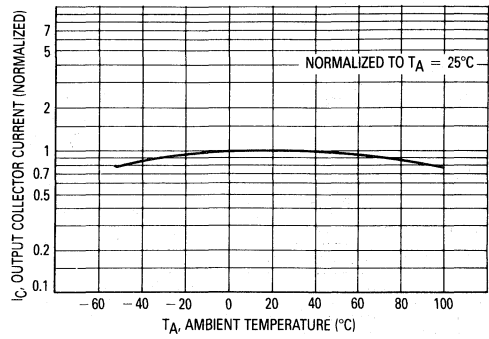

Figure 4. Output Current versus Ambient Temperature

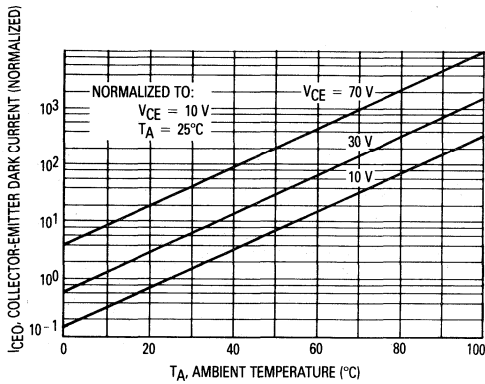

Figure 5. Dark Current versus Ambient Temperature

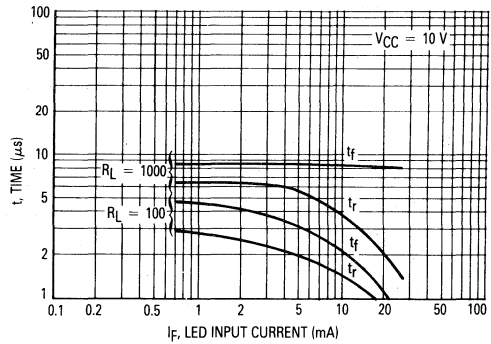

Figure 6. Rise and Fall Times

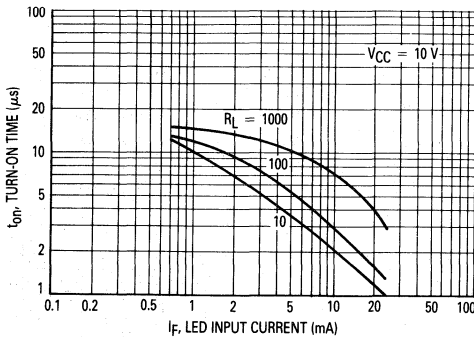

Figure 7. Turn-On Switching Times

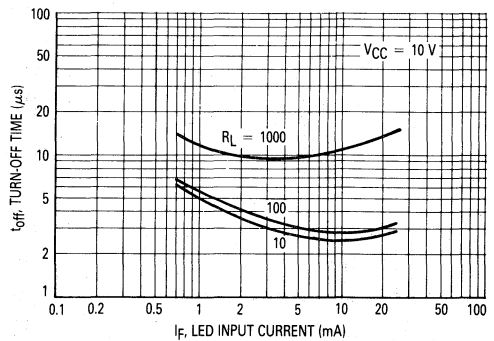

Figure 8. Turn-Off Switching Times

H11AV1, H11AV1A, H11AV2, H11AV2A, H11AV3, H11AV3A

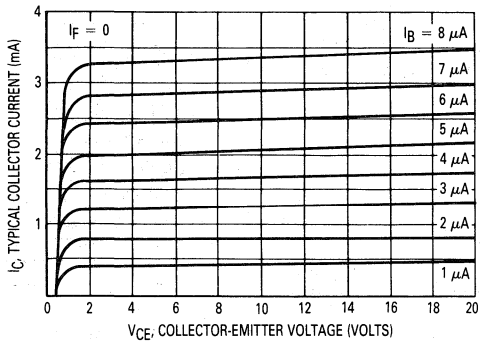

Figure 9. DC Current Gain (Detector Only)

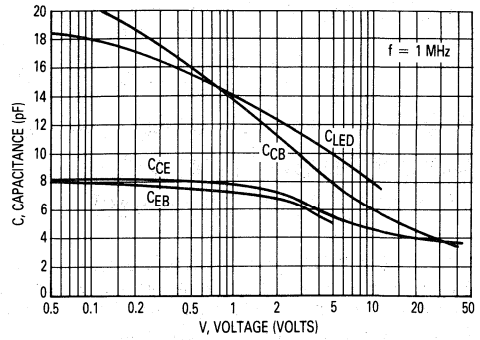

Figure 10. Capacitances versus Voltage

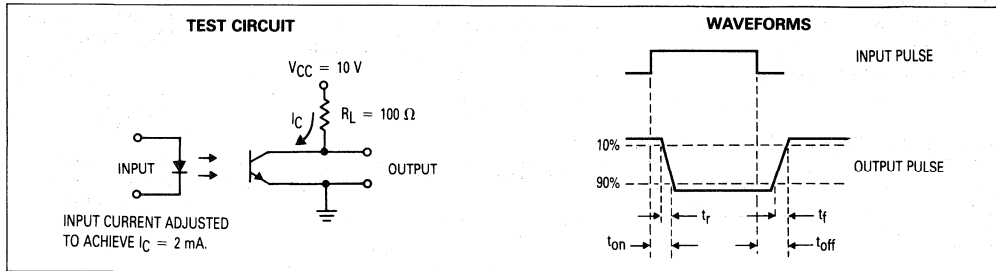
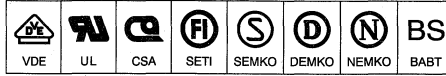

Figure 11. Switching Times



6-Pin DIP Optoisolators Darlington Output (Low Input Current)

The H11B1, H11B2 and H11B3 devices consist of a gallium arsenide infrared emitting diode optically coupled to a monolithic silicon photodarlington detector. They are designed for use in applications requiring high sensitivity at low input currents.

- High Sensitivity to Low Input Drive Current

Applications

- Appliances, Measuring Instruments
- I/O Interfaces for Computers
- Programmable Controllers
- Interfacing and coupling systems of different potentials and impedances
- Solid State Relays
- Portable Electronics

MAXIMUM RATINGS ($T_A = 25^\circ\text{C}$ unless otherwise noted)

Rating	Symbol	Value	Unit
INPUT LED			
Reverse Voltage	V_R	3	Volts
Forward Current — Continuous	I_F	60	mA
LED Power Dissipation @ $T_A = 25^\circ\text{C}$ with Negligible Power in Output Detector Derate above 25°C	P_D	150	mW
		1.41	mW/ $^\circ\text{C}$
OUTPUT DETECTOR			
Collector-Emitter Voltage	V_{CEO}	25	Volts
Emitter-Base Voltage	V_{EBO}	7	Volts
Collector-Base Voltage	V_{CBO}	30	Volts
Collector Current — Continuous	I_C	100	mA
Detector Power Dissipation @ $T_A = 25^\circ\text{C}$ with Negligible Power in Input LED Derate above 25°C	P_D	150	mW
		1.76	mW/ $^\circ\text{C}$
TOTAL DEVICE			
Isolation Surge Voltage (1) (Peak ac Voltage, 60 Hz, 1 sec Duration)	V_{ISO}	7500	Vac
Total Device Power Dissipation @ $T_A = 25^\circ\text{C}$ Derate above 25°C	P_D	250 2.94	mW mW/ $^\circ\text{C}$
Ambient Operating Temperature Range (2)	T_A	-55 to +100	$^\circ\text{C}$
Storage Temperature Range	T_{stg}	-55 to +150	$^\circ\text{C}$
Soldering Temperature (10 sec, 1/16" from case)	T_L	260	$^\circ\text{C}$

TOTAL DEVICE

(1) Isolation surge voltage is an internal device dielectric breakdown rating. For this test, Pins 1 and 2 are common, and Pins 4, 5 and 6 are common.

(2) Refer to Quality and Reliability Section for test information.

H11B1*

[CTR = 500% Min]

H11B2*

[CTR = 200% Min]

H11B3

[CTR = 100% Min]

*Motorola Preferred Devices
 STYLE 1 PLASTIC



STANDARD THRU HOLE
 CASE 730A-04



"T" LEADFORM
 WIDE SPACED 0.4"
 CASE 730D-05



"S"/"F" LEADFORM
 SURFACE MOUNT
 CASE 730C-04
 (STANDARD PROFILE)



CASE 730F-04
 (LOW PROFILE)

SCHEMATIC

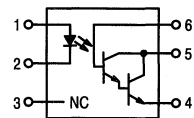

- PIN 1. LED ANODE
 2. LED CATHODE
 3. N.C.
 4. EMITTER
 5. COLLECTOR
 6. BASE

H11B1, H11B2, H11B3

ELECTRICAL CHARACTERISTICS (T_A = 25°C unless otherwise noted)

Characteristic	Symbol	Min	Typ	Max	Unit	
INPUT LED						
Forward Voltage (I _F = 10 mA)	H11B1, H11B2	V _F	—	1.15	1.5	Volts
Forward Voltage (I _F = 50 mA)	H11B3	V _F	—	1.34	1.5	Volts
Reverse Leakage Current (V _R = 3 V)	I _R	—	—	10	μA	
Capacitance (V = 0 V, f = 1 MHz)	C _J	—	18	—	pF	

OUTPUT DETECTOR

Collector-Emitter Dark Current (V _{CE} = 10 V)	I _{CEO}	—	5	100	nA
Collector-Emitter Breakdown Voltage (I _C = 10 mA)	V _{(BR)CEO}	25	80	—	Volts
Collector-Base Breakdown Voltage (I _C = 100 μA)	V _{(BR)CBO}	30	100	—	Volts
Emitter-Collector Breakdown Voltage (I _E = 100 μA)	V _{(BR)ECO}	7	—	—	Volts
DC Current Gain (I _C = 5 mA, V _{CE} = 5 V)	h _{FE}	—	16K	—	—
Collector-Emitter Capacitance (f = 1 MHz, V _{CE} = 5 V)	C _{CE}	—	4.9	—	pF
Collector-Base Capacitance (f = 1 MHz, V _{CB} = 5 V)	C _{CB}	—	6.3	—	pF
Emitter-Base Capacitance (f = 1 MHz, V _{EB} = 5 V)	C _{EB}	—	3.8	—	pF

COUPLED

Output Collector Current (I _F = 1 mA, V _{CE} = 5 V)	H11B1 H11B2 H11B3	I _C	5 2 1	— — —	— — —	mA
Collector-Emitter Saturation Voltage (I _C = 1 mA, I _F = 1 mA)		V _{CE(sat)}	—	0.7	1	Volts
Turn-On Time (I _F = 5 mA, V _{CC} = 10 V, R _L = 100 Ω)		t _{on}	—	3.5	—	μs
Turn-Off Time (I _F = 5 mA, V _{CC} = 10 V, R _L = 100 Ω)		t _{off}	—	95	—	μs
Rise Time (I _F = 5 mA, V _{CC} = 10 V, R _L = 100 Ω)		t _r	—	1	—	μs
Fall Time (I _F = 5 mA, V _{CC} = 10 V, R _L = 100 Ω)		t _f	—	2	—	μs
Isolation Voltage (f = 60 Hz, t = 1 sec) (2)		V _{ISO}	7500	—	—	Vac(pk)
Isolation Resistance (V = 500 V) (2)		R _{ISO}	10 ¹¹	—	—	Ω
Isolation Capacitance (V = 0 V, f = 1 MHz) (2)		C _{ISO}	—	0.2	—	pF

Note 2. For this test, Pins 1 and 2 are common, and Pins 4, 5 and 6 are common.

4

TYPICAL CHARACTERISTICS

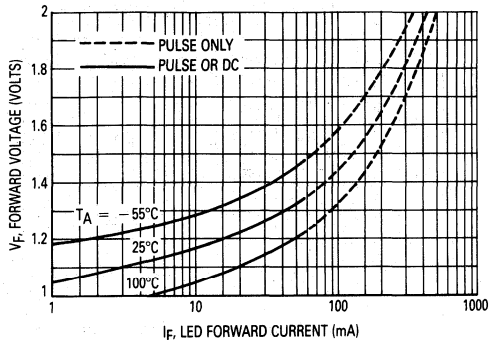

Figure 1. LED Forward Voltage versus Forward Current

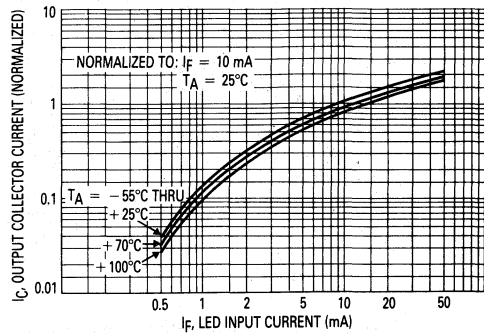

Figure 2. Output Current versus Input Current

H11B1, H11B2, H11B3

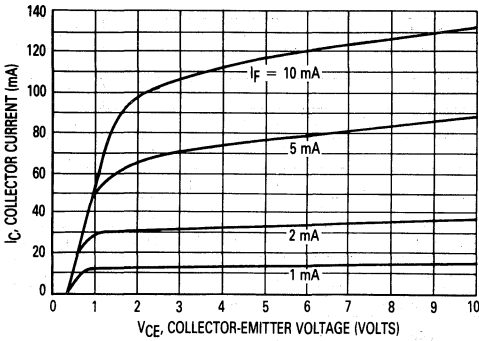

Figure 3. Collector Current versus Collector-Emitter Voltage

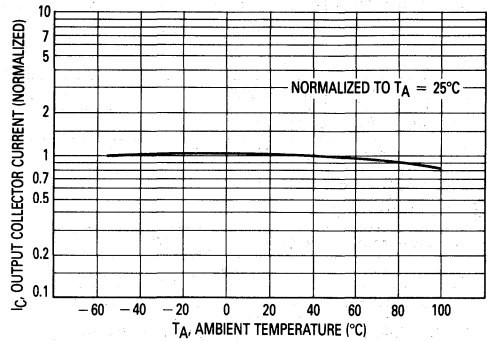

Figure 4. Output Current versus Ambient Temperature

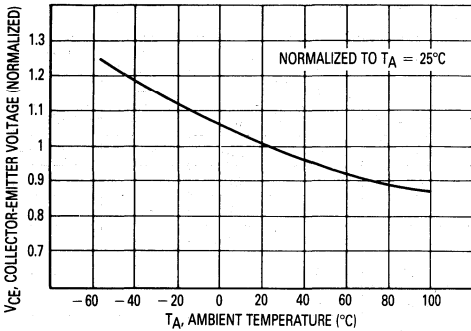

Figure 5. Collector-Emitter Voltage versus Ambient Temperature

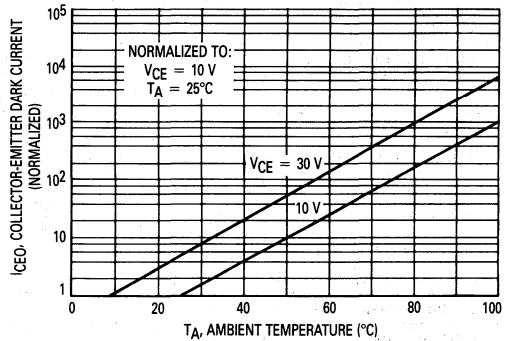

Figure 6. Collector-Emitter Dark Current versus Ambient Temperature

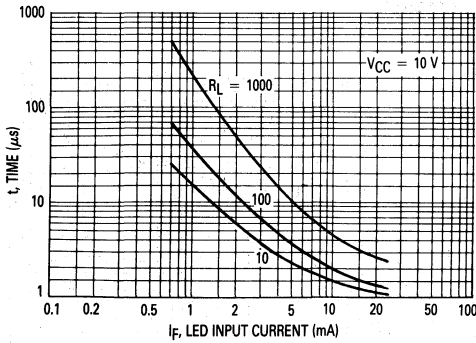

Figure 7. Turn-On Switching Times

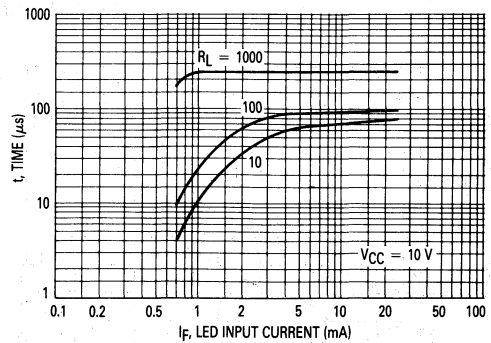

Figure 8. Turn-Off Switching Times

H11B1, H11B2, H11B3

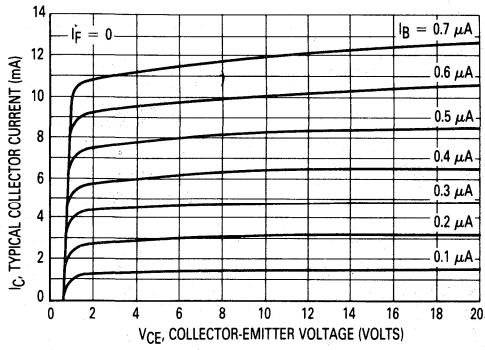

Figure 9. DC Current Gain (Detector Only)

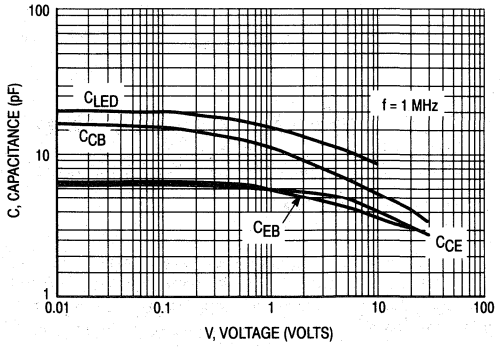

Figure 10. Capacitance versus Voltage

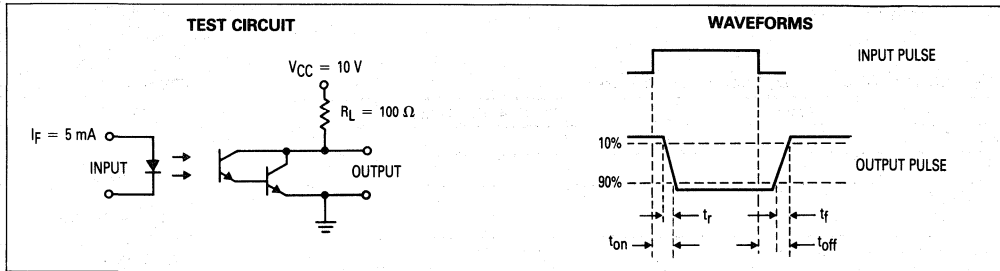

Figure 11. Switching Times

**MOTOROLA
SEMICONDUCTOR
TECHNICAL DATA**



6-Pin DIP Optoisolators High Voltage Transistor Output (300 Volts)

The H11D1 and H11D2 consist of gallium arsenide infrared emitting diodes optically coupled to high voltage, silicon, phototransistor detectors in a standard 6-pin DIP package. They are designed for applications requiring high voltage output and are particularly useful in copy machines and solid state relays.

Applications

- Copy Machines
- Interfacing and coupling systems of different potentials and impedances
- Monitor and Detection Circuits
- Solid State Relays

MAXIMUM RATINGS ($T_A = 25^\circ\text{C}$ unless otherwise noted)

Rating	Symbol	Value	Unit
INPUT LED			
Forward Current — Continuous	I_F	60	mA
Forward Current — Peak Pulse Width = 1 μs , 330 pps	I_F	1.2	Amps
LED Power Dissipation @ $T_A = 25^\circ\text{C}$ Derate above 25°C	P_D	120 1.41	mW mW/ $^\circ\text{C}$
OUTPUT TRANSISTOR			
Collector-Emitter Voltage	V_{CE}	300	Volts
Emitter-Collector Voltage	V_{EC}	7	Volts
Collector-Base Voltage	V_{CB}	300	Volts
Collector Current — Continuous	I_C	100	mA
Detector Power Dissipation @ $T_A = 25^\circ\text{C}$ Derate above 25°C	P_D	150 1.76	mW mW/ $^\circ\text{C}$

TOTAL DEVICE

Total Device Power Dissipation @ $T_A = 25^\circ\text{C}$ Derate above 25°C	P_D	250 2.94	mW mW/ $^\circ\text{C}$
Operating Temperature Range (3)	T_J	-55 to +100	$^\circ\text{C}$
Storage Temperature Range	T_{stg}	-55 to +150	$^\circ\text{C}$
Soldering Temperature (10 s)	T_L	260	$^\circ\text{C}$
Isolation Surge Voltage Peak ac Voltage, 60 Hz, 1 Second Duration (1)	V_{ISO}	7500	Vac(pk)

(1) Isolation surge voltage is an internal device dielectric breakdown rating. For this test, Pins 1 and 2 are common, and Pins 4, 5 and 6 are common.

(2) H11D1 is rated @ 5656 Volts peak (V_{ISO})
H11D2 is rated @ 3535 Volts peak (V_{ISO})
Otherwise they are identical, both parts built by Motorola are rated @ 7500 Volts peak (V_{ISO})

(3) Refer to Quality and Reliability Section for test information.

H11D1*
H11D2
[CTR = 20% Min]

*Motorola Preferred Device
STYLE 1 PLASTIC



**STANDARD THRU HOLE
CASE 730A-04**



**"T" LEADFORM
WIDE SPACED 0.4"
CASE 730D-05**



**"S"/"F" LEADFORM
SURFACE MOUNT
CASE 730C-04
(STANDARD PROFILE)**



**CASE 730F-04
(LOW PROFILE)**

SCHEMATIC

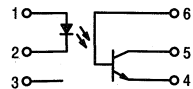

- PIN 1. ANODE
- CATHODE
- N.C.
- EMITTER
- COLLECTOR
- BASE

H11D1, H11D2

ELECTRICAL CHARACTERISTICS

Characteristic	Symbol	Min	Typ	Max	Unit
----------------	--------	-----	-----	-----	------

INPUT LED ($T_A = 25^\circ\text{C}$ unless otherwise noted)

Reverse Leakage Current ($V_R = 6\text{ V}$)	I_R	—	—	10	μA
Forward Voltage ($I_F = 10\text{ mA}$)	V_F	—	1.2	1.5	Volts
Capacitance ($V = 0\text{ V}, f = 1\text{ MHz}$)	C	—	18	—	pF

OUTPUT TRANSISTOR ($T_A = 25^\circ\text{C}$ and $I_F = 0$ unless otherwise noted)

Collector-Emitter Dark Current ($R_{BE} = 1\text{ M}\Omega$) ($V_{CE} = 200\text{ V}, T_A = 25^\circ\text{C}$) ($T_A = 100^\circ\text{C}$)	H11D1,2 H11D1,2	I_{CER}	— —	— —	100 250	nA μA
Collector-Base Breakdown Voltage ($I_C = 100\ \mu\text{A}$)	H11D1,2	$V_{(BR)CBO}$	—	—	300	Volts
Collector-Emitter Breakdown Voltage ($I_C = 1\text{ mA}, R_{BE} = 1\text{ M}\Omega$)	H11D1,2	$V_{(BR)CER}$	—	—	300	Volts
Emitter-Base Breakdown Voltage ($I_E = 100\ \mu\text{A}$)		$V_{(BR)EBO}$	7	—	—	Volts

COUPLED ($T_A = 25^\circ\text{C}$ unless otherwise noted)

Current Transfer Ratio ($V_{CE} = 10\text{ V}, I_F = 10\text{ mA}, R_{BE} = 1\text{ M}\Omega$)	H11D1,2	CTR	20	—	—	%
Surge Isolation Voltage (Input to Output) (1) Peak ac Voltage, 60 Hz, 1 sec		V_{ISO}	7500	—	—	Volts
Isolation Resistance (1) ($V = 500\text{ V}$)		R_{ISO}	—	10^{11}	—	Ohms
Collector-Emitter Saturation Voltage ($I_C = 0.5\text{ mA}, I_F = 10\text{ mA}, R_{BE} = 1\text{ M}\Omega$)		$V_{CE(sat)}$	—	—	0.4	Volts
Isolation Capacitance (1) ($V = 0, f = 1\text{ MHz}$)		C_{ISO}	—	0.2	—	pF
Turn-On Time	$V_{CC} = 10\text{ V}, I_C = 2\text{ mA}, R_L = 100\ \Omega$	t_{on}	—	5	—	μs
Turn-Off Time		t_{off}	—	5	—	μs

NOTE: 1. For this test LED Pins 1 and 2 are common and phototransistor Pins 4, 5, and 6 are common.

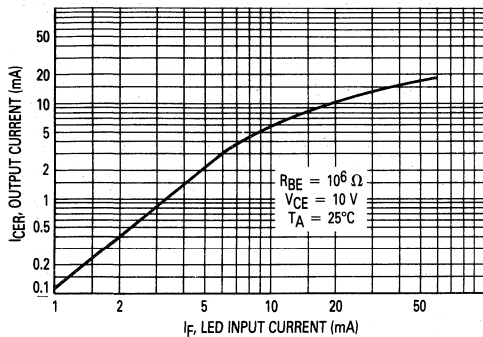

Figure 1. Output Current versus LED Input Current

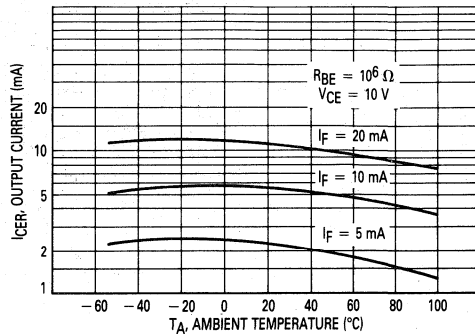

Figure 2. Output Current versus Temperature

H11D1, H11D2

TYPICAL ELECTRICAL CHARACTERISTICS

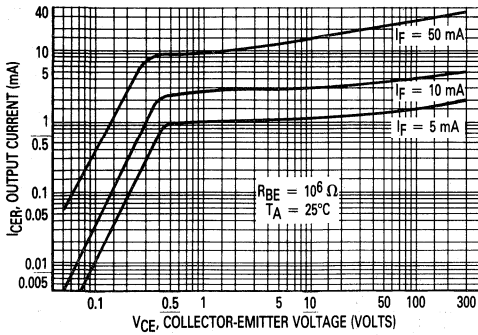

Figure 3. Output Characteristics

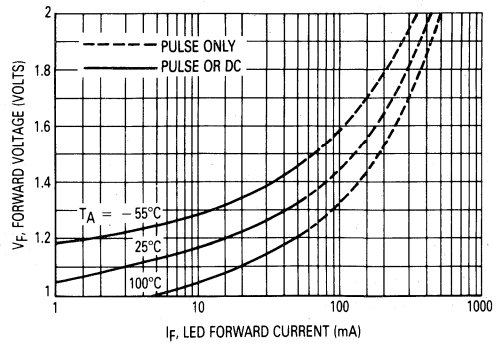

Figure 4. Forward Characteristics

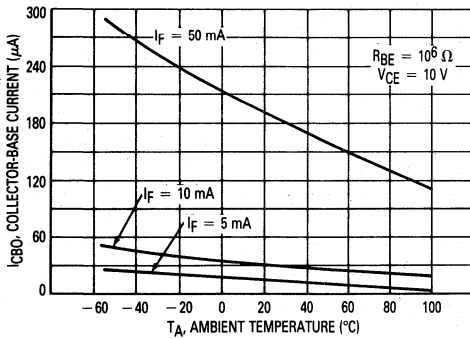

Figure 5. Collector-Base Current versus Temperature

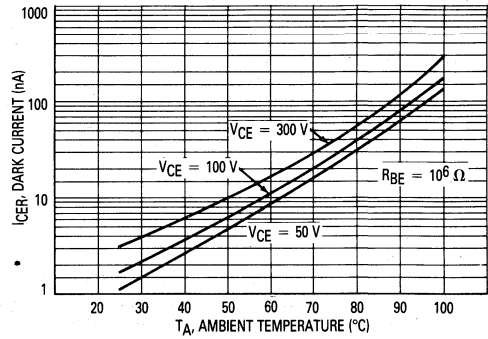

Figure 6. Dark Current versus Temperature

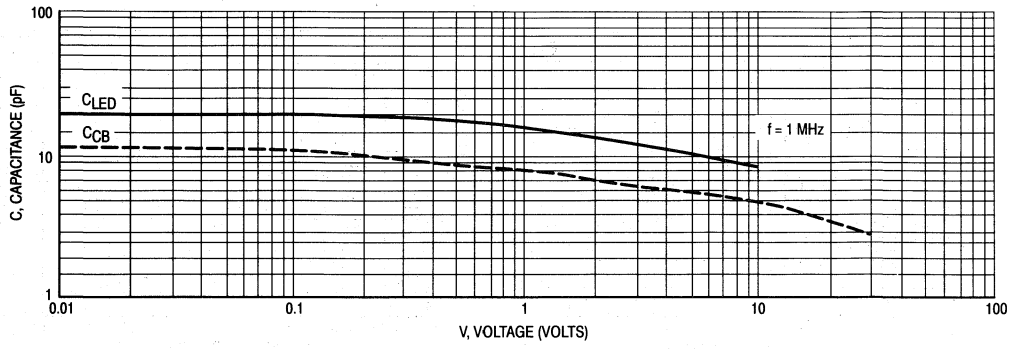

Figure 7. Capacitance versus Voltage

4



6-Pin DIP Optoisolators Darlingtons Output (On-Chip Resistors)

The H11G1, H11G2 and H11G3 devices consist of gallium arsenide IREs optically coupled to silicon photodarlington detectors which have integral base-emitter resistors. The on-chip resistors improve higher temperature leakage characteristics. Designed with high isolation, high CTR, high voltage and low leakage, they provide excellent performance.

- High CTR, H11G1 & H11G2 — 1000%
- High $V_{(BR)CEO}$, H11G1 — 100 Volts, H11G2 — 80 Volts

Applications

- Interfacing and coupling systems of different potentials and impedances
- Phase and Feedback Controls
- General Purpose Switching Circuits
- Solid State Relays

MAXIMUM RATINGS ($T_A = 25^\circ\text{C}$ unless otherwise noted)

Rating	Symbol	Value	Unit
--------	--------	-------	------

INPUT LED

Reverse Voltage	V_R	6	Volts
Forward Current — Continuous	I_F	60	mA
Forward Current — Peak Pulse Width = 300 μs , 2% Duty Cycle	I_F	3	Amps
LED Power Dissipation @ $T_A = 25^\circ\text{C}$ Derate above 25°C	P_D	120 1.41	mW mW/ $^\circ\text{C}$

OUTPUT DETECTOR

Collector-Emitter Voltage	V_{CEO}	100 80 55	Volts
Emitter-Base Voltage	V_{EBO}	7	Volts
Collector Current — Continuous	I_C	150	mA
Detector Power Dissipation @ $T_A = 25^\circ\text{C}$ Derate above 25°C	P_D	150 1.76	mW mW/ $^\circ\text{C}$

TOTAL DEVICE

Total Device Power Dissipation @ $T_A = 25^\circ\text{C}$ Derate above 25°C	P_D	250 2.94	mW mW/ $^\circ\text{C}$
Operating Junction Temperature Range (2)	T_A	-55 to +100	$^\circ\text{C}$
Storage Temperature Range	T_{stg}	-55 to +150	$^\circ\text{C}$
Soldering Temperature (10 s)	T_L	260	$^\circ\text{C}$
Isolation Surge Voltage (1) (Peak ac Voltage, 60 Hz, 1 sec Duration)	V_{ISO}	7500	Vac(pk)

(1) Isolation surge voltage is an internal device dielectric breakdown rating. For this test, Pins 1 and 2 are common, and Pins 4, 5 and 6 are common.

(2) Refer to Quality and Reliability Section for test information.

H11G1*

[CTR = 1000% Min]

H11G2*

[CTR = 1000% Min]

H11G3

[CTR = 200% Min]

*Motorola Preferred Devices
 STYLE 1 PLASTIC



STANDARD THRU HOLE
 CASE 730A-04



"T" LEADFORM
 WIDE SPACED 0.4"
 CASE 730D-05



"S"/"F" LEADFORM
 SURFACE MOUNT
 CASE 730C-04
 (STANDARD PROFILE)



CASE 730F-04
 (LOW PROFILE)

SCHEMATIC

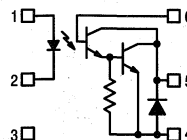

- PIN 1. ANODE
 2. CATHODE
 3. N.C.
 4. EMITTER
 5. COLLECTOR
 6. BASE

H11G1, H11G2, H11G3

ELECTRICAL CHARACTERISTICS ($T_A = 25^\circ\text{C}$ unless otherwise noted)

Characteristic	Symbol	Min	Typ	Max	Unit
INPUT LED					
Reverse Leakage Current ($V_R = 3\text{ V}$)	I_R	—	0.05	10	μA
Forward Voltage ($I_F = 10\text{ mA}$)	V_F	—	1.1	1.5	Volts
Capacitance ($V = 0\text{ V}$, $f = 1\text{ MHz}$)	C_J	—	18	—	pF

DARLINGTON OUTPUT ($T_A = 25^\circ\text{C}$ and $I_F = 0$ unless otherwise noted)

Collector-Emitter Breakdown Voltage ($I_C = 1\text{ mA}$, $I_F = 0$)	H11G1 H11G2 H11G3	$V_{(BR)CEO}$	100 80 55	— — —	— — —	Volts
Collector-Base Breakdown Voltage ($I_C = 100\ \mu\text{A}$, $I_F = 0$)	H11G1 H11G2 H11G3	$V_{(BR)CBO}$	100 80 55	— — —	— — —	Volts
Emitter-Base Breakdown Voltage ($I_E = 100\ \mu\text{A}$, $I_F = 0$)		$V_{(BR)EBO}$	7	—	—	Volts
Collector-Emitter Dark Current ($V_{CE} = 80\text{ V}$)	H11G1	I_{CE}	—	—	100	nA
($V_{CE} = 80\text{ V}$, $T_A = 80^\circ\text{C}$)	H11G1		—	—	100	μA
($V_{CE} = 60\text{ V}$)	H11G2		—	—	100	nA
($V_{CE} = 60\text{ V}$, $T_A = 80^\circ\text{C}$)	H11G2		—	—	100	μA
($V_{CE} = 30\text{ V}$)	H11G3		—	—	100	nA
Capacitance ($V_{CB} = 10\text{ V}$, $f = 1\text{ MHz}$)		C_{CB}	—	6	—	pF

COUPLED ($T_A = 25^\circ\text{C}$ unless otherwise noted)

Collector Output Current ($V_{CE} = 1\text{ V}$, $I_F = 10\text{ mA}$)	H11G1, 2	I_C	100	—	—	mA
($V_{CE} = 5\text{ V}$, $I_F = 1\text{ mA}$)	H11G1, 2		5	—	—	
($V_{CE} = 5\text{ V}$, $I_F = 1\text{ mA}$)	H11G3		2	—	—	
Collector-Emitter Saturation Voltage ($I_F = 1\text{ mA}$, $I_C = 1\text{ mA}$)	H11G1, 2	$V_{CE(sat)}$	—	0.75	1	Volts
($I_F = 16\text{ mA}$, $I_C = 50\text{ mA}$)	H11G1, 2		—	0.85	1	
($I_F = 20\text{ mA}$, $I_C = 50\text{ mA}$)	H11G3		—	0.85	1.2	
Isolation Surge Voltage (1, 2) (60 Hz ac Peak, 1 Second)		V_{ISO}	7500	—	—	Volts
Isolation Resistance (1) ($V = 500\text{ Vdc}$)			—	10^{11}	—	Ohms
Isolation Capacitance (1) ($V = 0\text{ V}$, $f = 1\text{ MHz}$)		C_{IO}	—	2	—	pF

SWITCHING ($T_A = 25^\circ\text{C}$)

Turn-On Time	($I_F = 10\text{ mA}$, $V_{CC} = 5\text{ V}$, $R_L = 100\ \Omega$, Pulse Width $\leq 300\ \mu\text{s}$, $f = 30\text{ Hz}$)	t_{on}	—	5	—	μs
Turn-Off Time		t_{off}	—	100	—	

- (1) For this test LED Pins 1 and 2 are common and Photodarlington Pins 4 and 5 are common.
 (2) Isolation Surge Voltage, V_{ISO} , is an internal device dielectric breakdown rating.

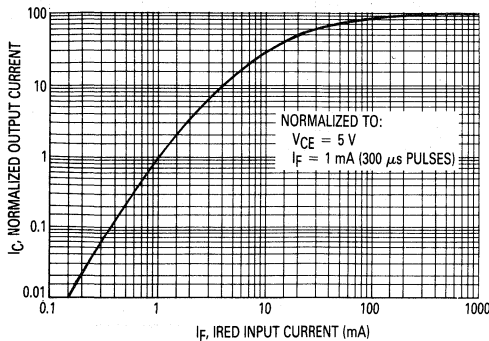

Figure 1. Output Current versus Input Current

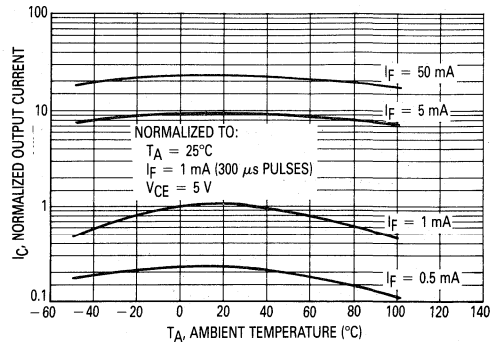

Figure 2. Output Current versus Temperature

H11G1, H11G2, H11G3

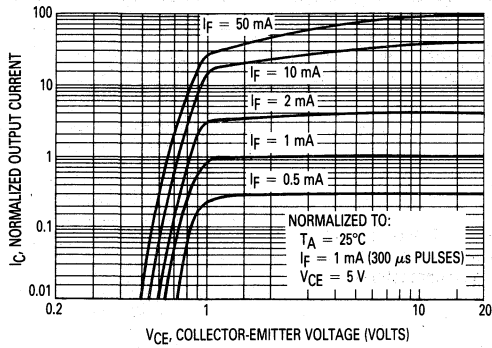

Figure 3. Output Current versus Collector-Emitter Voltage

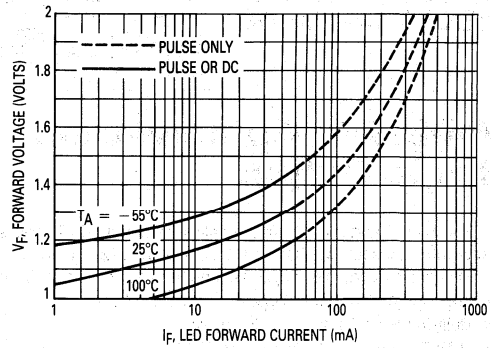

Figure 4. LED Forward Characteristics

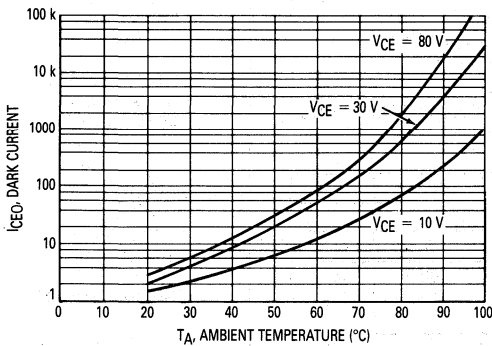

Figure 5. Collector-Emitter Dark Current versus Temperature

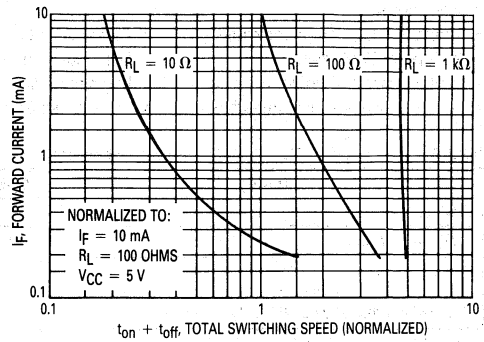
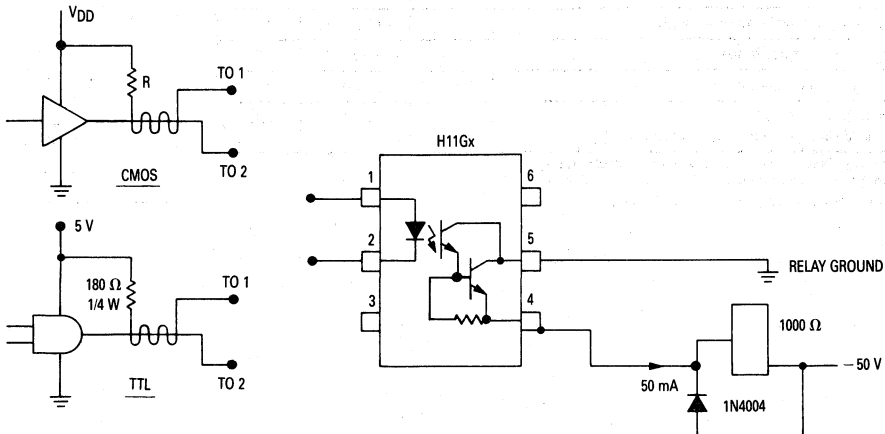

Figure 6. Input Current versus Total Switching Speed

INTERFACING TTL OR CMOS LOGIC TO 50-VOLT, 1000-OHMS RELAY FOR TELEPHONY APPLICATIONS

In order to interface positive logic to negative-powered electromechanical relays, a change in voltage level and polarity plus electrical isolation are required. The H11Gx can provide this interface and eliminate the external amplifiers and voltage divider networks previously required. The circuit below shows a typical approach for the interface.





6-Pin DIP Optoisolators Logic Output

The H11L1 and H11L2 have a gallium arsenide IRED optically coupled to a high-speed integrated detector with Schmitt trigger output. Designed for applications requiring electrical isolation, fast response time, noise immunity and digital logic compatibility.

- Guaranteed Switching Times — $t_{on}, t_{off} < 4 \mu s$
- Built-In On/Off Threshold Hysteresis
- High Data Rate, 1 MHz Typical (NRZ)
- Wide Supply Voltage Capability
- Microprocessor Compatible Drive

Applications

- Interfacing Computer Terminals to Peripheral Equipment
- Digital Control of Motors and Other Servo Machine Applications
- Digital Control of Power Supplies
- Logic to Logic Isolator
- Line Receiver — Eliminates Noise
- Logic Level Shifter — Couples TTL to CMOS

MAXIMUM RATINGS ($T_A = 25^\circ C$ unless otherwise noted)

Rating	Symbol	Value	Unit
--------	--------	-------	------

INPUT LED

Reverse Voltage	V_R	6	Volts
Forward Current — Continuous — Peak Pulse Width = 300 μs , 2% Duty Cycle	I_F	60 1.2	mA Amp
LED Power Dissipation @ $T_A = 25^\circ C$ Derate above $25^\circ C$	P_D	120 1.41	mW mW/ $^\circ C$

OUTPUT DETECTOR

Output Voltage Range	V_O	0–16	Volts
Supply Voltage Range	V_{CC}	3–16	Volts
Output Current	I_O	50	mA
Detector Power Dissipation @ $T_A = 25^\circ C$ Derate above $25^\circ C$	P_D	150 1.76	mW mW/ $^\circ C$

TOTAL DEVICE

Total Device Dissipation @ $T_A = 25^\circ C$ Derate above $25^\circ C$	P_D	250 2.94	mW mW/ $^\circ C$
Maximum Operating Temperature (2)	T_A	-40 to +85	$^\circ C$
Storage Temperature Range	T_{stg}	-55 to +150	$^\circ C$
Soldering Temperature (10 s)	T_L	260	$^\circ C$
Isolation Surge Voltage (Pk ac Voltage, 60 Hz, 1 Second Duration) (1)	V_{ISO}	7500	Volts

(1) Isolation surge voltage is an internal device dielectric breakdown rating. For this test, Pins 1 and 2 are common, and Pins 4, 5 and 6 are common.

(2) Refer to Quality and Reliability Section for test information.

H11L1*

[$I_F(on) = 1.6 \text{ mA Max}$]

H11L2

[$I_F(on) = 10 \text{ mA Max}$]

*Motorola Preferred Device

STYLE 5 PLASTIC



STANDARD THRU HOLE
CASE 730A-04



"T" LEADFORM
WIDE SPACED 0.4"
CASE 730D-05



"S"/"F" LEADFORM
SURFACE MOUNT
CASE 730C-04
(STANDARD PROFILE)



CASE 730F-04
(LOW PROFILE)

SCHEMATIC

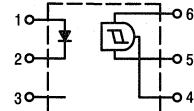

PIN 1. ANODE
2. CATHODE
3. V_D
4. GROUND
5. V_{CC}
6. OUTPUT

H11L1, H11L2

ELECTRICAL CHARACTERISTICS (T_A = 0 to 70°C)

Characteristic	Symbol	Min	Typ	Max	Unit	
INPUT LED						
Reverse Leakage Current (V _R = 3 V, R _L = 1 MΩ)	I _R	—	0.05	10	μA	
Forward Voltage (I _F = 10 mA (I _F = 0.3 mA))	V _F	— 0.75	1.2 0.95	1.5	Volts	
Capacitance (V _R = 0 V, f = 1 MHz)	C	—	18	—	pF	
OUTPUT DETECTOR						
Operating Voltage	V _{CC}	3	—	15	Volts	
Supply Current (I _F = 0, V _{CC} = 5 V)	I _{CC(off)}	—	1	5	mA	
Output Current, High (I _F = 0, V _{CC} = V _O = 15 V)	I _{OH}	—	—	100	μA	
COUPLED						
Supply Current (I _F = I _{F(on)} , V _{CC} = 5 V)	I _{CC(on)}	—	1.6	5	mA	
Output Voltage, Low (R _L = 270 Ω, V _{CC} = 5 V, I _F = I _{F(on)})	V _{OL}	—	0.2	0.4	Volts	
Threshold Current, ON (R _L = 270 Ω, V _{CC} = 5 V)	I _{F(on)}	—	1	1.6 10	mA	
Threshold Current, OFF (R _L = 270 Ω, V _{CC} = 5 V)	I _{F(off)}	0.3 0.3	0.75 —	—	mA	
Hysteresis Ratio (R _L = 270 Ω, V _{CC} = 5 V)	I _{F(off)} / I _{F(on)}	0.5	0.75	0.9		
Isolation Voltage (1) 60 Hz, AC Peak, 1 second, T _A = 25°C	V _{ISO}	7500	—	—	Vac(pk)	
Turn-On Time	R _L = 270 Ω V _{CC} = 5 V, I _F = I _{F(on)} T _A = 25°C	t _{on}	—	1.2	4	μs
Fall Time		t _f	—	0.1	—	
Turn-Off Time		t _{off}	—	1.2	4	
Rise Time		t _r	—	0.1	—	

(1) For this test IRED Pins 1 and 2 are common and Output Gate Pins 4, 5, 6 are common.

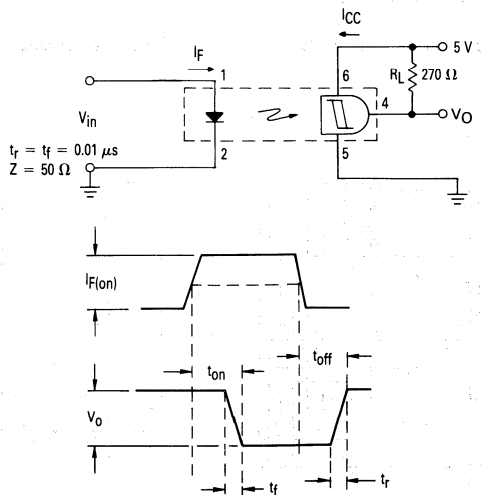

Figure 1. Switching Test Circuit

H11L1, H11L2

TYPICAL CHARACTERISTICS

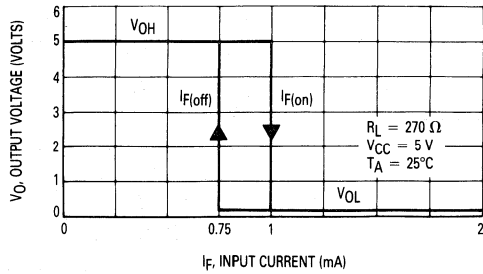

Figure 2. Transfer Characteristics for H11L1

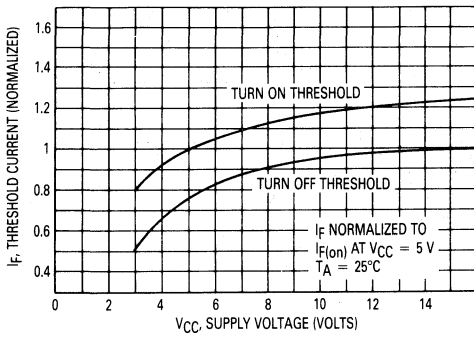

Figure 3. Threshold Current versus Supply Voltage

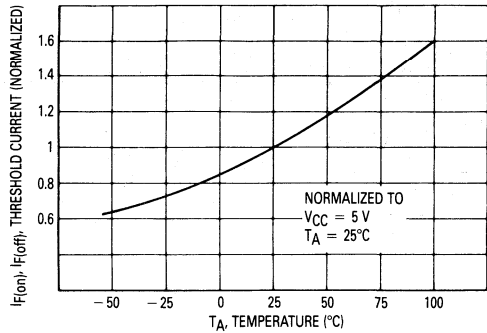

Figure 4. Threshold Current versus Temperature

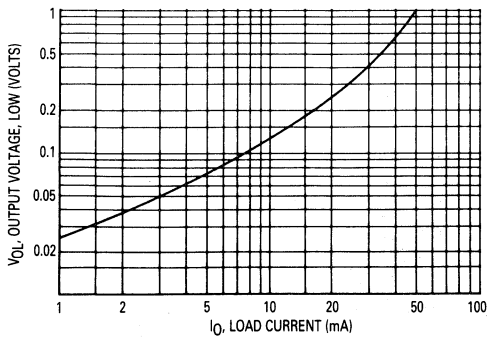

Figure 5. Output Voltage, Low versus Load Current

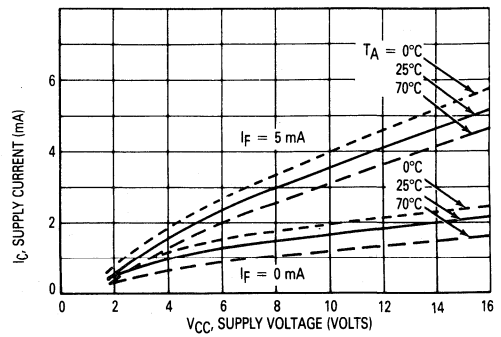

Figure 6. Supply Current versus Supply Voltage

**MOTOROLA
SEMICONDUCTOR
TECHNICAL DATA**



**6-Pin DIP Optoisolators
Transistor Output**

The MCT and MCT2E devices consist of a gallium arsenide infrared emitting diode optically coupled to a monolithic silicon phototransistor detector.

Applications

- General Purpose Switching Circuits
- Interfacing and coupling systems of different potentials and impedances
- I/O Interfacing
- Solid State Relays
- Monitor and Detection Circuits

MAXIMUM RATINGS ($T_A = 25^\circ\text{C}$ unless otherwise noted)

Rating	Symbol	Value	Unit
--------	--------	-------	------

INPUT LED

Reverse Voltage	V_R	3	Volts
Forward Current — Continuous	I_F	60	mA
LED Power Dissipation @ $T_A = 25^\circ\text{C}$ with Negligible Power in Output Detector Derate above 25°C	P_D	120	mW
		1.41	mW/ $^\circ\text{C}$

OUTPUT TRANSISTOR

Collector-Emitter Voltage	V_{CEO}	30	Volts
Emitter-Collector Voltage	V_{ECO}	7	Volts
Collector-Base Voltage	V_{CBO}	70	Volts
Collector Current — Continuous	I_C	150	mA
Detector Power Dissipation @ $T_A = 25^\circ\text{C}$ with Negligible Power in Input LED Derate above 25°C	P_D	150	mW
		1.76	mW/ $^\circ\text{C}$

TOTAL DEVICE

Isolation Surge Voltage (1) (Peak ac Voltage, 60 Hz, 1 sec Duration)	V_{ISO}	7500	Vac
Total Device Power Dissipation @ $T_A = 25^\circ\text{C}$ Derate above 25°C	P_D	250 2.94	mW mW/ $^\circ\text{C}$
Ambient Operating Temperature Range (2)	T_A	-55 to +100	$^\circ\text{C}$
Storage Temperature Range	T_{stg}	-55 to +150	$^\circ\text{C}$
Soldering Temperature (10 sec, 1/16" from case)	T_L	260	$^\circ\text{C}$

(1) Isolation surge voltage is an internal device dielectric breakdown rating. For this test, Pins 1 and 2 are common, and Pins 4, 5 and 6 are common.

(2) Refer to Quality and Reliability Section for test information.

**MCT2
MCT2E**
[CTR = 20% Min]

STYLE 1 PLASTIC



STANDARD THRU HOLE
CASE 730A-04



"T" LEADFORM
WIDE SPACED 0.4"
CASE 730D-05



"S"/"F" LEADFORM
SURFACE MOUNT
CASE 730C-04
(STANDARD PROFILE)



CASE 730F-04
(LOW PROFILE)

SCHEMATIC

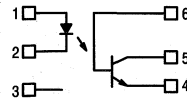

- PIN 1. LED ANODE
- 2. LED CATHODE
- 3. N.C.
- 4. EMITTER
- 5. COLLECTOR
- 6. BASE

MCT2, MCT2E

ELECTRICAL CHARACTERISTICS ($T_A = 25^\circ\text{C}$ unless otherwise noted)

Characteristic	Symbol	Min	Typ	Max	Unit
INPUT LED					
Forward Voltage ($I_F = 20\text{ mA}$)	V_F	—	$T_A = 25^\circ\text{C}$	1.23	Volts
			$T_A = -55^\circ\text{C}$	1.35	
			$T_A = 100^\circ\text{C}$	1.15	
Reverse Leakage Current ($V_R = 3\text{ V}$)	I_R	—	0.01	10	μA
Capacitance ($V = 0\text{ V}$, $f = 1\text{ MHz}$)	C_J	—	18	—	pF
OUTPUT TRANSISTOR					
Collector-Emitter Dark Current ($V_{CE} = 10\text{ V}$)	I_{CEO}	—	$T_A = 25^\circ\text{C}$	1	nA
			$T_A = 100^\circ\text{C}$	1	
Collector-Base Dark Current ($V_{CB} = 10\text{ V}$)	I_{CBO}	—	$T_A = 25^\circ\text{C}$	0.2	nA
			$T_A = 100^\circ\text{C}$	100	
Collector-Emitter Breakdown Voltage ($I_C = 1\text{ mA}$)	$V_{(BR)CEO}$	30	45	—	Volts
Collector-Base Breakdown Voltage ($I_C = 10\text{ }\mu\text{A}$)	$V_{(BR)CBO}$	70	100	—	Volts
Emitter-Collector Breakdown Voltage ($I_E = 100\text{ }\mu\text{A}$)	$V_{(BR)ECO}$	7	7.8	—	Volts
DC Current Gain ($I_C = 5\text{ mA}$, $V_{CE} = 5\text{ V}$)	h_{FE}	—	500	—	—
Collector-Emitter Capacitance ($f = 1\text{ MHz}$, $V_{CE} = 0\text{ V}$)	C_{CE}	—	7	—	pF
Collector-Base Capacitance ($f = 1\text{ MHz}$, $V_{CB} = 0\text{ V}$)	C_{CB}	—	19	—	pF
Emitter-Base Capacitance ($f = 1\text{ MHz}$, $V_{EB} = 0\text{ V}$)	C_{EB}	—	9	—	pF
COUPLED					
Output Collector Current ($I_F = 10\text{ mA}$, $V_{CE} = 10\text{ V}$)	I_C	2	7	—	mA
Collector-Emitter Saturation Voltage ($I_C = 2\text{ mA}$, $I_F = 16\text{ mA}$)	$V_{CE(sat)}$	—	0.19	0.4	Volts
Turn-On Time ($I_F = 10\text{ mA}$, $V_{CC} = 10\text{ V}$, $R_L = 100\text{ }\Omega$, Figure 11)	t_{on}	—	2.8	—	μs
Turn-Off Time ($I_F = 10\text{ mA}$, $V_{CC} = 10\text{ V}$, $R_L = 100\text{ }\Omega$, Figure 11)	t_{off}	—	4.5	—	μs
Rise Time ($I_F = 10\text{ mA}$, $V_{CC} = 10\text{ V}$, $R_L = 100\text{ }\Omega$, Figure 11)	t_r	—	1.2	—	μs
Fall Time ($I_F = 10\text{ mA}$, $V_{CC} = 10\text{ V}$, $R_L = 100\text{ }\Omega$, Figure 11)	t_f	—	1.3	—	μs
Isolation Voltage ($f = 60\text{ Hz}$, $t = 1\text{ sec}$)	V_{ISO}	7500	—	—	Vac(pk)
Isolation Resistance ($V = 500\text{ V}$)	R_{ISO}	10^{11}	—	—	Ω
Isolation Capacitance ($V = 0\text{ V}$, $f = 1\text{ MHz}$)	C_{ISO}	—	0.2	—	pF

TYPICAL CHARACTERISTICS

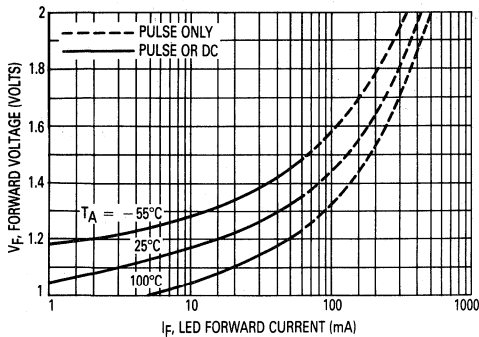

Figure 1. LED Forward Voltage versus Forward Current

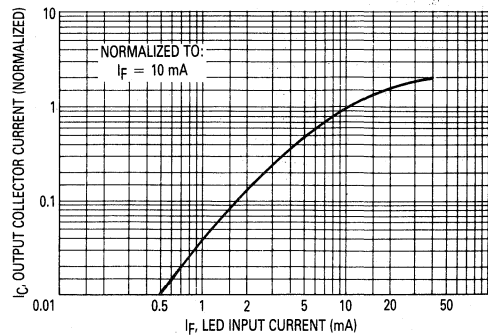

Figure 2. Output Current versus Input Current

MCT2, MCT2E

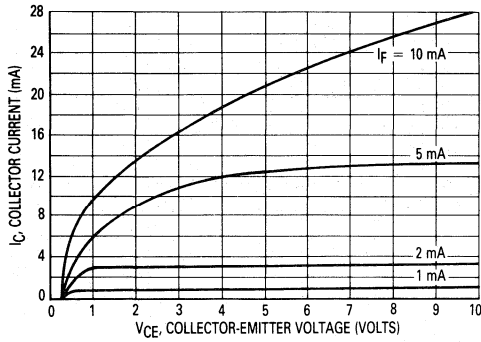

Figure 3. Collector Current versus Collector-Emitter Voltage

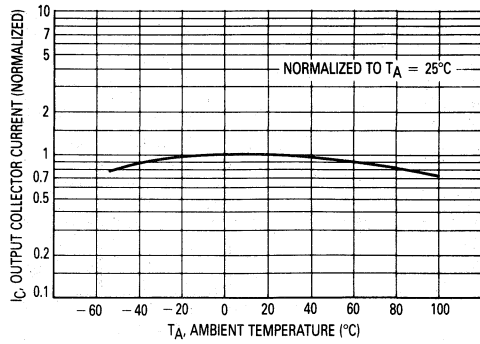

Figure 4. Output Current versus Ambient Temperature

4

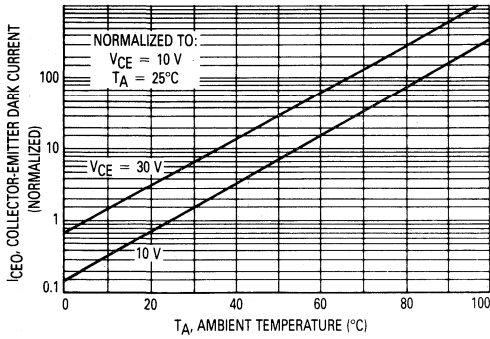

Figure 5. Dark Current versus Ambient Temperature

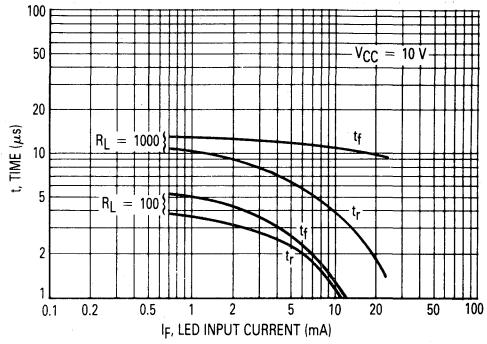

Figure 6. Rise and Fall Times

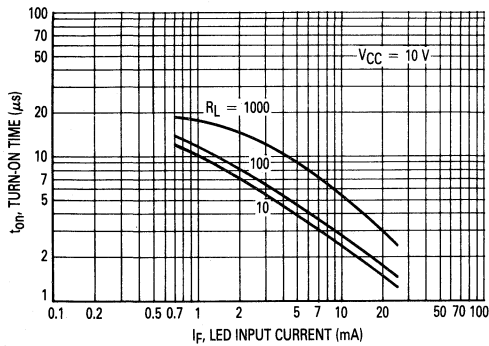

Figure 7. Turn-On Switching Times

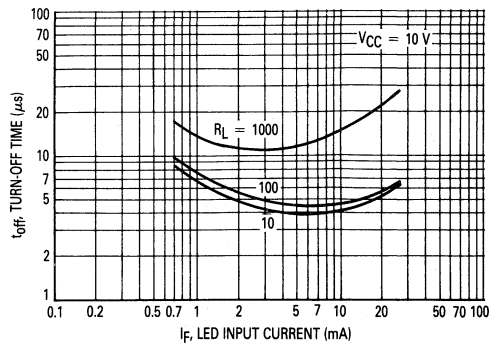

Figure 8. Turn-Off Switching Times

MCT2, MCT2E

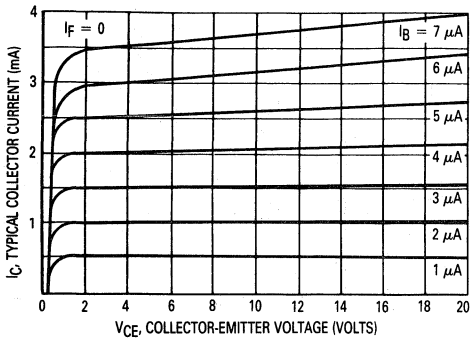

Figure 9. DC Current Gain (Detector Only)

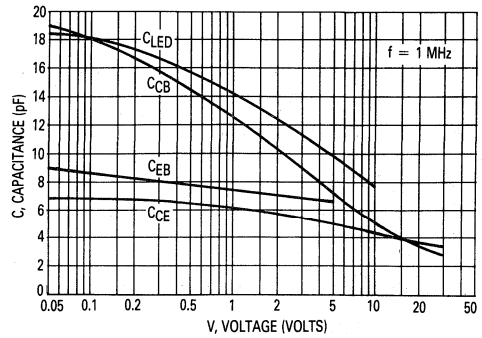

Figure 10. Capacitances versus Voltage

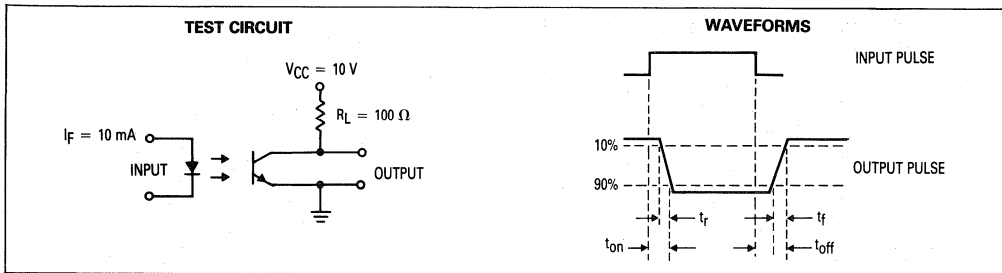

Figure 11. Switching Times

4

MOTOROLA
SEMICONDUCTOR
TECHNICAL DATA



6-Pin DIP Optoisolator
Darlington Output
(No Base Connection)

The MOC119 device consists of a gallium arsenide infrared emitting diode optically coupled to a monolithic silicon photodarlington detector.

It is designed for use in applications requiring high sensitivity at low input currents.

- No Base Connection for Improved Noise Immunity
- High Sensitivity to Low Input Drive Current

Applications

- Appliance, Measuring Instruments
- Interfacing and coupling systems of different potentials and impedances
- Monitor and Detection Circuits
- I/O Interfaces for Computers
- Solid State Relays
- Portable Electronics
- Programmable Controllers

MAXIMUM RATINGS ($T_A = 25^\circ\text{C}$ unless otherwise noted)

Rating	Symbol	Value	Unit
INPUT LED			
Reverse Voltage	V_R	3	Volts
Forward Current — Continuous	I_F	60	mA
LED Power Dissipation @ $T_A = 25^\circ\text{C}$ with Negligible Power in Output Detector Derate above 25°C	P_D	120	mW
		1.41	mW/ $^\circ\text{C}$

OUTPUT DETECTOR

Collector-Emitter Voltage	V_{CEO}	30	Volts
Emitter-Collector Voltage	V_{ECO}	7	Volts
Detector Power Dissipation @ $T_A = 25^\circ\text{C}$ with Negligible Power in Input LED Derate above 25°C	P_D	150	mW
		1.76	mW/ $^\circ\text{C}$

TOTAL DEVICE

Isolation Surge Voltage (1) (Peak ac Voltage, 60 Hz, 1 sec Duration)	V_{ISO}	7500	Vac
Total Device Power Dissipation @ $T_A = 25^\circ\text{C}$ Derate above 25°C	P_D	250 2.94	mW mW/ $^\circ\text{C}$
Ambient Operating Temperature Range (2)	T_A	-55 to +100	$^\circ\text{C}$
Storage Temperature Range	T_{stg}	-55 to +150	$^\circ\text{C}$
Soldering Temperature (10 sec, 1/16" from case)	T_L	260	$^\circ\text{C}$

(1) Isolation surge voltage is an internal device dielectric breakdown rating. For this test, Pins 1 and 2 are common, and Pins 4, 5 and 6 are common.

(2) Refer to Quality and Reliability Section for test information.

MOC119

[CTR = 300% Min]

STYLE 3 PLASTIC



STANDARD THRU HOLE
CASE 730A-04



"T" LEADFORM
WIDE SPACED 0.4"
CASE 730D-05



"S"/"F" LEADFORM
SURFACE MOUNT
CASE 730C-04
(STANDARD PROFILE)



CASE 730F-04
(LOW PROFILE)

SCHEMATIC

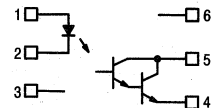

- PIN 1. LED ANODE
- LED CATHODE
- N.C.
- EMITTER
- COLLECTOR
- N.C.

MOC119

ELECTRICAL CHARACTERISTICS ($T_A = 25^\circ\text{C}$ unless otherwise noted)

Characteristic	Symbol	Min	Typ	Max	Unit
INPUT LED					
Reverse Leakage Current ($V_R = 3\text{ V}$)	I_R	—	0.05	100	μA
Forward Voltage ($I_F = 10\text{ mA}$)	V_F	—	1.15	1.5	Volts
Capacitance ($V_R = 0\text{ V}$, $f = 1\text{ MHz}$)	C	—	18	—	pF

PHOTOTRANSISTOR ($T_A = 25^\circ\text{C}$ and $I_F = 0$ unless otherwise noted)

Collector-Emitter Dark Current ($V_{CE} = 10\text{ V}$)	I_{CEO}	—	—	100	nA
Collector-Emitter Breakdown Voltage ($I_C = 100\ \mu\text{A}$)	$V_{(BR)CEO}$	30	—	—	Volts
Emitter-Collector Breakdown Voltage ($I_E = 10\ \mu\text{A}$)	$V_{(BR)ECO}$	7	—	—	Volts

COUPLED ($T_A = 25^\circ\text{C}$ unless otherwise noted)

Collector Output Current (1) ($V_{CE} = 2\text{ V}$, $I_F = 10\text{ mA}$)	I_C	30	45	—	mA
Isolation Surge Voltage (2, 5), 60 Hz ac Peak, 1 Second	V_{ISO}	7500	—	—	Volts
Isolation Resistance (2) ($V = 500\text{ V}$)	R_{ISO}	—	10^{11}	—	Ohms
Collector-Emitter Saturation Voltage (1) ($I_C = 10\text{ mA}$, $I_F = 10\text{ mA}$)	$V_{CE(sat)}$	—	—	1	Volt
Isolation Capacitance (2) ($V = 0\text{ V}$, $f = 1\text{ MHz}$)	C_{ISO}	—	0.2	—	pF

SWITCHING (Figures 4, 5)

Turn-On Time	$V_{CE} = 10\text{ V}$, $R_L = 100\ \Omega$, $I_F = 5\text{ mA}$	t_{on}	—	3.5	—	μs
Turn-Off Time		t_{off}	—	95	—	
Rise Time		t_r	—	1	—	
Fall Time		t_f	—	2	—	

(1) Pulse Test: Pulse Width = $300\ \mu\text{s}$, Duty Cycle $\leq 2\%$.

(2) For this test LED Pins 1 and 2 are common and Phototransistor Pins 4 and 5 are common.

(3) Isolation Surge Voltage, V_{ISO} , is an internal device dielectric breakdown rating.

TYPICAL CHARACTERISTICS

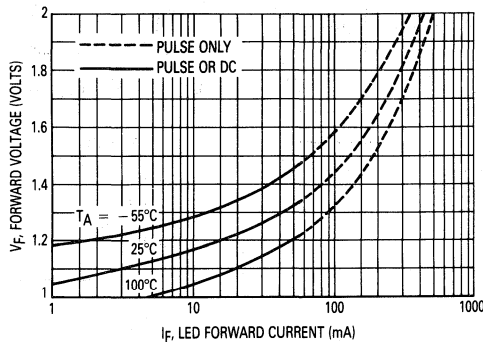

Figure 1. LED Forward Voltage versus Forward Current

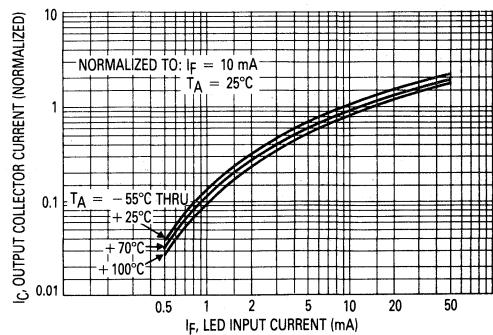

Figure 2. Output Current versus Input Current

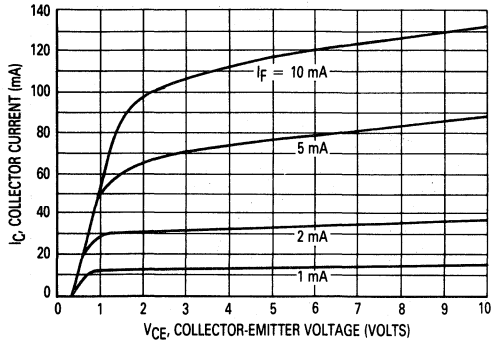

Figure 3. Collector Current versus Collector-Emitter Voltage

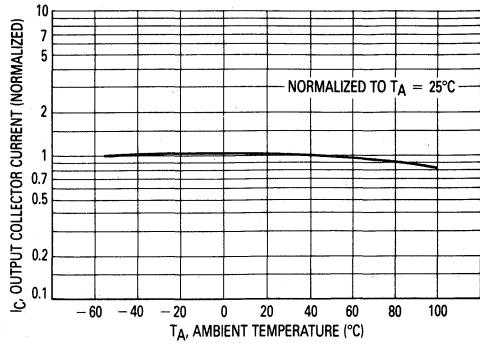

Figure 4. Output Current versus Ambient Temperature

4

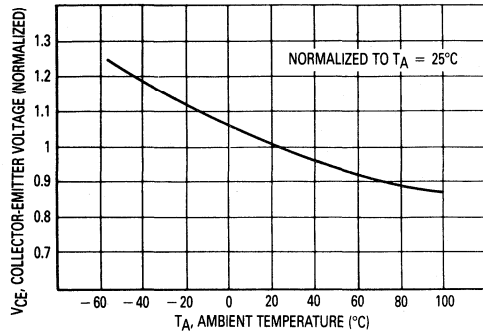

Figure 5. Collector-Emitter Voltage versus Ambient Temperature

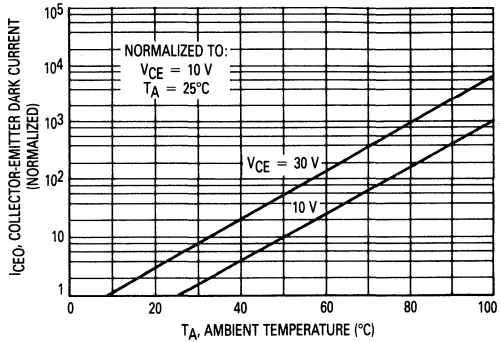

Figure 6. Collector-Emitter Dark Current versus Ambient Temperature

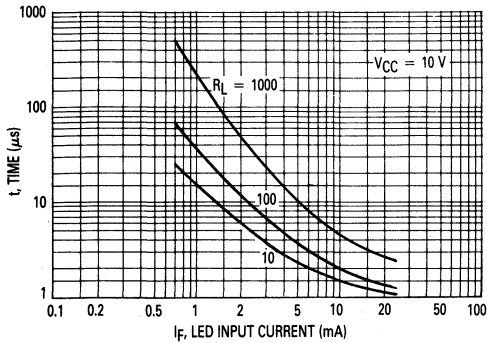

Figure 7. Turn-On Switching Times

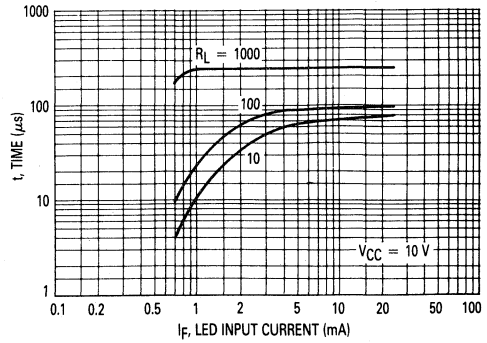

Figure 8. Turn-Off Switching Times

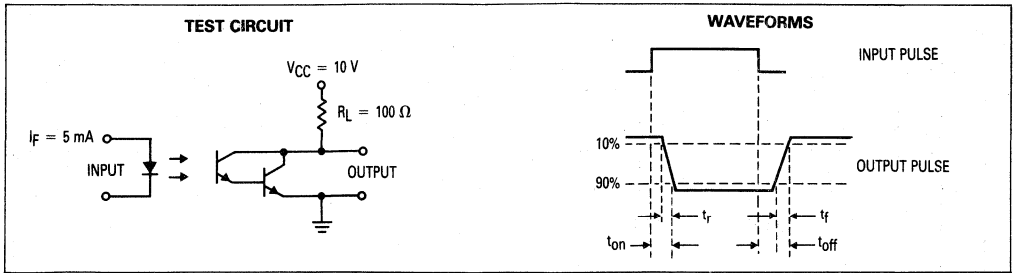

Figure 9. Switching Times

**MOTOROLA
SEMICONDUCTOR
TECHNICAL DATA**



**6-Pin DIP Optoisolators
Triac Driver Output (250 Volts)**

The MOC3009 Series consists of gallium arsenide infrared emitting diodes, optically coupled to silicon bilateral switch and are designed for applications requiring isolated triac triggering, low-current isolated ac switching, high electrical isolation (to 7500 V peak), high detector standoff voltage, small size, and low cost.

Applications

- Solenoid/Valve Controls
- Lamp Ballasts
- Interfacing Microprocessors to 115 Vac Peripherals
- Motor Controls
- Static ac Power Switch
- Solid State Relays
- Incandescent Lamp Dimmers

MAXIMUM RATINGS ($T_A = 25^\circ\text{C}$ unless otherwise noted)

Rating	Symbol	Value	Unit
INFRARED EMITTING DIODE			
Reverse Voltage	V_R	3	Volts
Forward Current — Continuous	I_F	60	mA
Total Power Dissipation @ $T_A = 25^\circ\text{C}$ Negligible Power in Transistor Derate above 25°C	P_D	100	mW
		1.33	mW/ $^\circ\text{C}$

OUTPUT DRIVER

Off-State Output Terminal Voltage	V_{DRM}	250	Volts
Peak Repetitive Surge Current ($PW = 1 \text{ ms}, 120 \text{ pps}$)	I_{TSM}	1	A
Total Power Dissipation @ $T_A = 25^\circ\text{C}$ Derate above 25°C	P_D	300	mW
		4	mW/ $^\circ\text{C}$

TOTAL DEVICE

Isolation Surge Voltage (1) (Peak ac Voltage, 60 Hz, 5 Second Duration)	V_{ISO}	7500	Vac
Total Power Dissipation @ $T_A = 25^\circ\text{C}$ Derate above 25°C	P_D	330	mW
		4.4	mW/ $^\circ\text{C}$
Junction Temperature Range	T_J	-40 to +100	$^\circ\text{C}$
Ambient Operating Temperature Range (2)	T_A	-40 to +85	$^\circ\text{C}$
Storage Temperature Range	T_{stg}	-40 to +150	$^\circ\text{C}$
Soldering Temperature (10 s)	T_L	260	$^\circ\text{C}$

(1) Isolation surge voltage, V_{ISO} , is an internal device dielectric breakdown rating. For this test, Pins 1 and 2 are common, and Pins 4, 5 and 6 are common.

(2) Refer to Quality and Reliability Section for test information.

MOC3009
[IFT = 30 mA Max]
MOC3010*
[IFT = 15 mA Max]
MOC3011
[IFT = 10 mA Max]
MOC3012*
[IFT = 5 mA Max]
*Motorola Preferred Devices
STYLE 6 PLASTIC



**STANDARD THRU HOLE
CASE 730A-04**



**"T" LEADFORM
WIDE SPACED 0.4"
CASE 730D-05**



**"S"/"F" LEADFORM
SURFACE MOUNT
CASE 730C-04
(STANDARD PROFILE)**



**CASE 730F-04
(LOW PROFILE)**

COUPLER SCHEMATIC

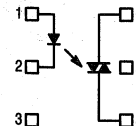

1. ANODE
2. CATHODE
3. NC
4. MAIN TERMINAL
5. SUBSTRATE
DO NOT CONNECT
6. MAIN TERMINAL

MOC3009, MOC3010, MOC3011, MOC3012

ELECTRICAL CHARACTERISTICS ($T_A = 25^\circ\text{C}$ unless otherwise noted)

Characteristic	Symbol	Min	Typ	Max	Unit
----------------	--------	-----	-----	-----	------

INPUT LED

Reverse Leakage Current ($V_R = 3\text{ V}$)	I_R	—	0.05	100	μA
Forward Voltage ($I_F = 10\text{ mA}$)	V_F	—	1.15	1.5	Volts

OUTPUT DETECTOR ($I_F = 0$ unless otherwise noted)

Peak Blocking Current, Either Direction (Rated V_{DRM} , Note 1)	I_{DRM}	—	10	100	nA
Peak On-State Voltage, Either Direction ($I_{TM} = 100\text{ mA Peak}$)	V_{TM}	—	1.8	3	Volts
Critical Rate of Rise of Off-State Voltage (Figure 7, Note 2)	dv/dt	—	10	—	$\text{V}/\mu\text{s}$

COUPLED

LED Trigger Current, Current Required to Latch Output (Main Terminal Voltage = 3 V, Note 3)	MOC3009	I_{FT}	—	15	30	mA
	MOC3010		—	8	15	
	MOC3011		—	5	10	
	MOC3012		—	3	5	
Holding Current, Either Direction	I_H	—	100	—	μA	

- Notes: 1. Test voltage must be applied within dv/dt rating.
 2. This is static dv/dt. See Figure 7 for test circuit. Commutating dv/dt is a function of the load-driving thyristor(s) only.
 3. All devices are guaranteed to trigger at an I_F value less than or equal to max I_{FT} . Therefore, recommended operating I_F lies between max I_{FT} (30 mA for MOC3009, 15 mA for MOC3010, 10 mA for MOC3011, 5 mA for MOC3012) and absolute max I_F (60 mA).

TYPICAL ELECTRICAL CHARACTERISTICS

$T_A = 25^\circ\text{C}$

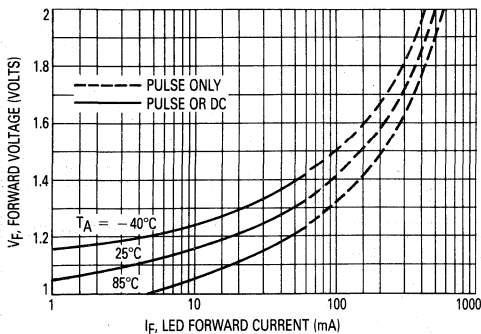

Figure 1. LED Forward Voltage versus Forward Current

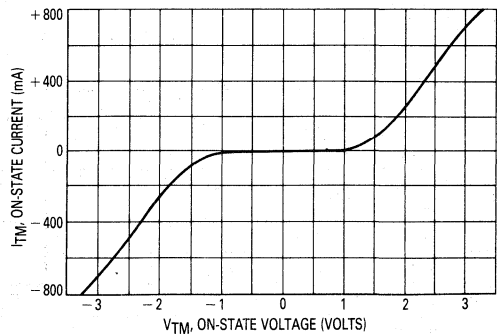

Figure 2. On-State Characteristics

MOC3009, MOC3010, MOC3011, MOC3012

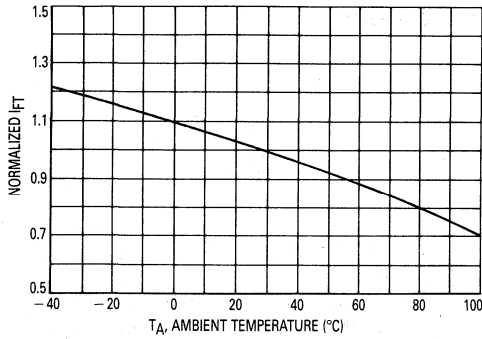

Figure 3. Trigger Current versus Temperature

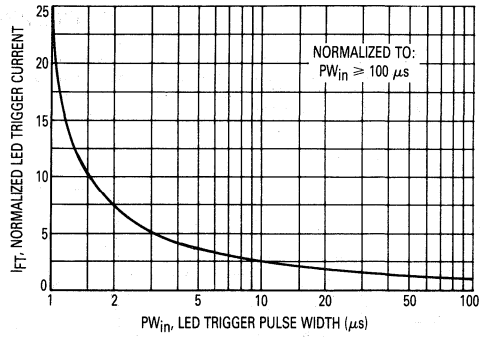

Figure 4. LED Current Required to Trigger versus LED Pulse Width

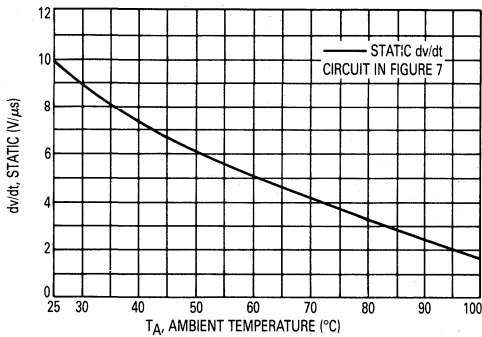

Figure 5. dv/dt versus Temperature

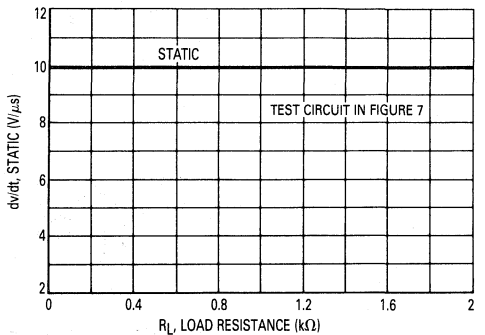
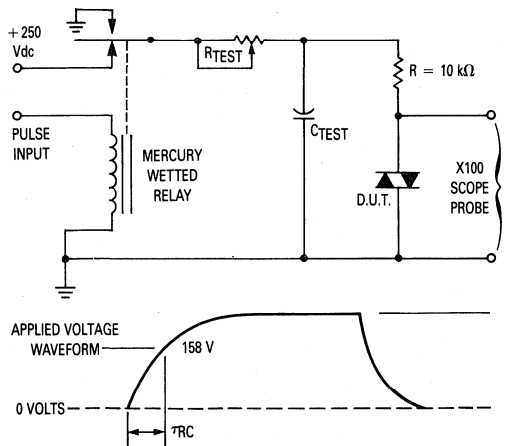

Figure 6. dv/dt versus Load Resistance



1. The mercury wetted relay provides a high speed repeated pulse to the D.U.T.
2. 100x scope probes are used, to allow high speeds and voltages.
3. The worst-case condition for static dv/dt is established by triggering the D.U.T. with a normal LED input current, then removing the current. The variable R_{TEST} allows the dv/dt to be gradually increased until the D.U.T. continues to trigger in response to the applied voltage pulse, even after the LED current has been removed. The dv/dt is then decreased until the D.U.T. stops triggering. τ_{RC} is measured at this point and recorded.

Figure 7. Static dv/dt Test Circuit

MOC3009, MOC3010, MOC3011, MOC3012

TYPICAL APPLICATION CIRCUITS

Note: This optoisolator should not be used to drive a load directly. It is intended to be a trigger device only. Additional information on the use of the MOC3009/3010/3011/3012 is available in Application Note AN-780A.

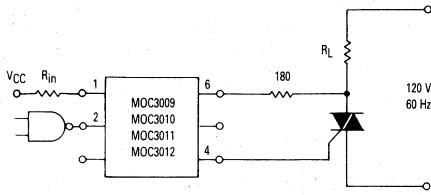

Figure 8. Resistive Load

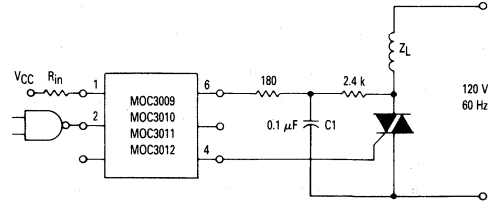

Figure 9. Inductive Load with Sensitive Gate Triac ($I_{GT} \leq 15 \text{ mA}$)

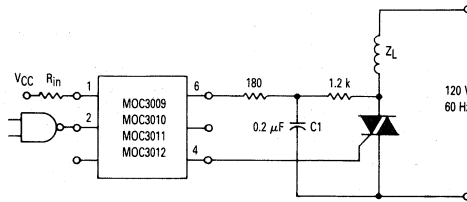
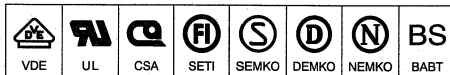

Figure 10. Inductive Load with Non-Sensitive Gate Triac ($15 \text{ mA} < I_{GT} < 50 \text{ mA}$)

MOTOROLA SEMICONDUCTOR TECHNICAL DATA



6-Pin DIP Optoisolators Triac Driver Output (400 Volts)

The MOC3020 Series consists of gallium arsenide infrared emitting diodes, optically coupled to a silicon bilateral switch.

They are designed for applications requiring isolated triac triggering.

- Output Driver Designed for 240 Vac Line

Applications

- Solenoid/Valve Controls
- Lamp Ballasts
- Interfacing Microprocessors to 115 Vac Peripherals
- Motor Controls
- Static ac Power Switch
- Solid State Relays
- Incandescent Lamp Dimmers

MAXIMUM RATINGS ($T_A = 25^\circ\text{C}$ unless otherwise noted)

Rating	Symbol	Value	Unit
--------	--------	-------	------

INFRARED EMITTING DIODE

Reverse Voltage	V_R	3	Volts
Forward Current — Continuous	I_F	60	mA
Total Power Dissipation @ $T_A = 25^\circ\text{C}$ Negligible Power in Triac Driver Derate above 25°C	P_D	100	mW
		1.33	mW/ $^\circ\text{C}$

OUTPUT DRIVER

Off-State Output Terminal Voltage	V_{DRM}	400	Volts
Peak Repetitive Surge Current (PW = 1 ms, 120 pps)	I_{TSM}	1	A
Total Power Dissipation @ $T_A = 25^\circ\text{C}$ Derate above 25°C	P_D	300	mW
		4	mW/ $^\circ\text{C}$

TOTAL DEVICE

Isolation Surge Voltage (1) (Peak ac Voltage, 60 Hz, 5 Second Duration)	V_{ISO}	7500	Vac
Total Power Dissipation @ $T_A = 25^\circ\text{C}$ Derate above 25°C	P_D	330	mW
		4.4	mW/ $^\circ\text{C}$
Junction Temperature Range	T_J	-40 to +100	$^\circ\text{C}$
Ambient Operating Temperature Range (2)	T_A	-40 to +85	$^\circ\text{C}$
Storage Temperature Range	T_{stg}	-40 to +150	$^\circ\text{C}$
Soldering Temperature (10 s)	T_L	260	$^\circ\text{C}$

(1) Isolation surge voltage, V_{ISO} , is an internal device dielectric breakdown rating. For this test, Pins 1 and 2 are common, and Pins 4, 5 and 6 are common.

(2) Refer to Quality and Reliability Section for test information.

MOC3020

[IFT = 30 mA Max]

MOC3021*

[IFT = 15 mA Max]

MOC3022

[IFT = 10 mA Max]

MOC3023

[IFT = 5 mA Max]

*Motorola Preferred Device

STYLE 6 PLASTIC



STANDARD THRU HOLE
CASE 730A-04



"T" LEADFORM
WIDE SPACED 0.4"
CASE 730D-05



"S"/"F" LEADFORM
SURFACE MOUNT
CASE 730C-04
(STANDARD PROFILE)



CASE 730F-04
(LOW PROFILE)

COUPLER SCHEMATIC

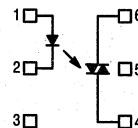

1. ANODE
2. CATHODE
3. NC
4. MAIN TERMINAL
5. SUBSTRATE
DO NOT CONNECT
6. MAIN TERMINAL

MOC3020, MOC3021, MOC3022, MOC3023

ELECTRICAL CHARACTERISTICS ($T_A = 25^\circ\text{C}$ unless otherwise noted)

Characteristic	Symbol	Min	Typ	Max	Unit
----------------	--------	-----	-----	-----	------

INPUT LED

Reverse Leakage Current ($V_R = 3\text{ V}$)	I_R	—	0.05	100	μA
Forward Voltage ($I_F = 10\text{ mA}$)	V_F	—	1.15	1.5	Volts

OUTPUT DETECTOR ($I_F = 0$ unless otherwise noted)

Peak Blocking Current, Either Direction (Rated V_{DRM} , Note 1)	I_{DRM}	—	10	100	nA
Peak On-State Voltage, Either Direction ($I_{TM} = 100\text{ mA Peak}$)	V_{TM}	—	1.8	3	Volts
Critical Rate of Rise of Off-State Voltage (Figure 7, Note 2)	dv/dt	—	10	—	$\text{V}/\mu\text{s}$

COUPLED

LED Trigger Current, Current Required to Latch Output (Main Terminal Voltage = 3 V, Note 3)	I_{FT}	—	15	30	mA
	MOC3020	—	8	15	
	MOC3021	—	—	10	
	MOC3022	—	—	5	
	MOC3023	—	—	—	
Holding Current, Either Direction	I_H	—	100	—	μA

Notes: 1. Test voltage must be applied within dv/dt rating.

2. This is static dv/dt . See Figure 7 for test circuit. Commutating dv/dt is a function of the load-driving thyristor(s) only.

3. All devices are guaranteed to trigger at an I_F value less than or equal to max I_{FT} . Therefore, recommended operating I_F lies between max I_{FT} (30 mA for MOC3020, 15 mA for MOC3021, 10 mA for MOC3022, 5 mA for MOC3023) and absolute max I_F (60 mA).

TYPICAL ELECTRICAL CHARACTERISTICS

$T_A = 25^\circ\text{C}$

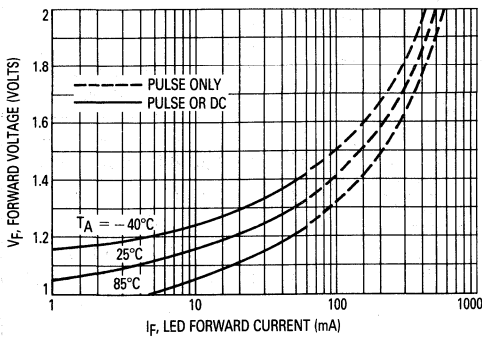

Figure 1. LED Forward Voltage versus Forward Current

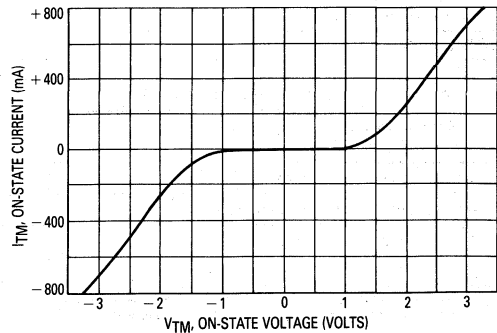

Figure 2. On-State Characteristics

MOC3020, MOC3021, MOC3022, MOC3023

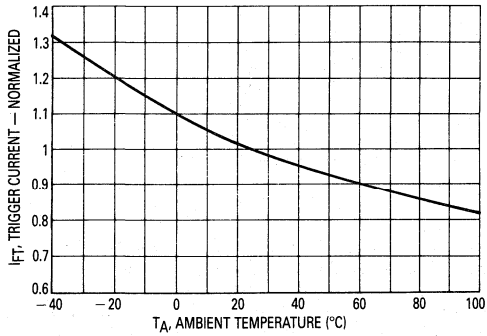

Figure 3. Trigger Current versus Temperature

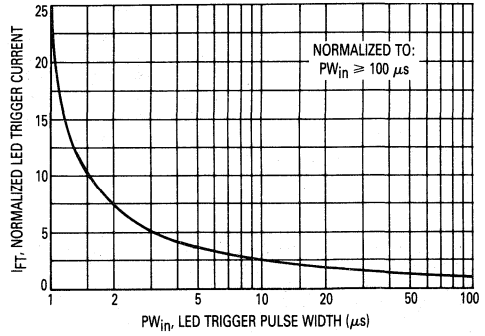

Figure 4. LED Current Required to Trigger versus LED Pulse Width

4

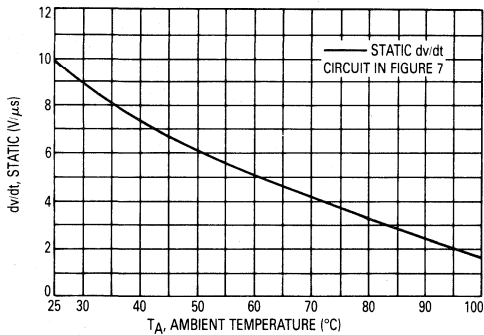

Figure 5. dv/dt versus Temperature

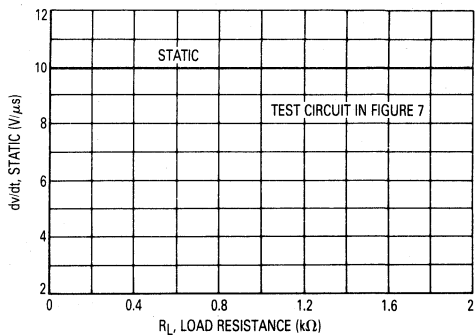
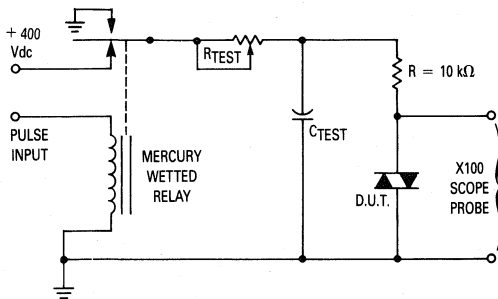

Figure 6. dv/dt versus Load Resistance



1. The mercury wetted relay provides a high speed repeated pulse to the D.U.T.
2. 100x scope probes are used, to allow high speeds and voltages.
3. The worst-case condition for static dv/dt is established by triggering the D.U.T. with a normal LED input current, then removing the current. The variable R_{TEST} allows the dv/dt to be gradually increased until the D.U.T. continues to trigger in response to the applied voltage pulse, even after the LED current has been removed. The dv/dt is then decreased until the D.U.T. stops triggering. τ_{RC} is measured at this point and recorded.

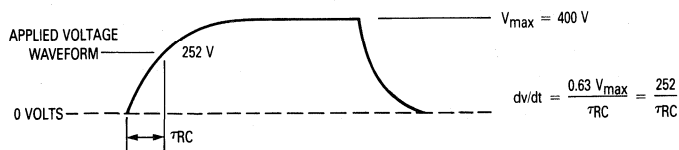
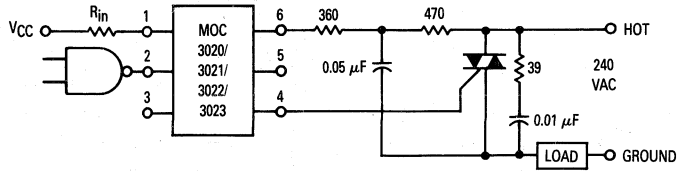

Figure 7. Static dv/dt Test Circuit

MOC3020, MOC3021, MOC3022, MOC3023



*This optoisolator should not be used to drive a load directly. It is intended to be a trigger device only.

Additional information on the use of optically coupled triac drivers is available in Application Note AN-780A.

In this circuit the "hot" side of the line is switched and the load connected to the cold or ground side.

The 39 ohm resistor and 0.01 μF capacitor are for snubbing of the triac, and the 470 ohm resistor and 0.05 μF capacitor are for snubbing the coupler. These components may or may not be necessary depending upon the particular triac and load used.

Figure 8. Typical Application Circuit

MOTOROLA SEMICONDUCTOR TECHNICAL DATA



6-Pin DIP Optoisolators Triac Driver Output (250 Volts)

The MOC3031, MOC3032 and MOC3033 devices consist of gallium arsenide infrared emitting diodes optically coupled to a monolithic silicon detector performing the function of a Zero Voltage crossing bilateral triac driver.

They are designed for use with a triac in the interface of logic systems to equipment powered from 115 Vac lines, such as teletypewriters, CRTs, printers, motors, solenoids and consumer appliances, etc.

- Simplifies Logic Control of 115 Vac Power
- Zero Voltage Crossing
- dv/dt of 2000 V/μs Typical, 1000 V/μs Guaranteed

Applications

- Solenoid/Valve Controls
- Lighting Controls
- Static Power Switches
- AC Motor Drives
- Temperature Controls
- E.M. Contactors
- AC Motor Starters
- Solid State Relays

MAXIMUM RATINGS ($T_A = 25^\circ\text{C}$ unless otherwise noted)

Rating	Symbol	Value	Unit
INFRARED LED			
Reverse Voltage	V_R	3	Volts
Forward Current — Continuous	I_F	60	mA
Total Power Dissipation @ $T_A = 25^\circ\text{C}$ Negligible Power in Output Driver Derate above 25°C	P_D	120	mW
		1.41	mW/°C

OUTPUT DRIVER

Off-State Output Terminal Voltage	V_{DRM}	250	Volts
Peak Repetitive Surge Current ($PW = 100 \mu\text{s}$, 120 pps)	I_{TSM}	1	A
Total Power Dissipation @ $T_A = 25^\circ\text{C}$ Derate above 25°C	P_D	150	mW
		1.76	mW/°C

TOTAL DEVICE

Isolation Surge Voltage (1) (Peak ac Voltage, 60 Hz, 1 Second Duration)	V_{ISO}	7500	Vac
Total Power Dissipation @ $T_A = 25^\circ\text{C}$ Derate above 25°C	P_D	250	mW
		2.94	mW/°C
Junction Temperature Range	T_J	-40 to +100	°C
Ambient Operating Temperature Range (2)	T_A	-40 to +85	°C
Storage Temperature Range	T_{stg}	-40 to +150	°C
Soldering Temperature (10 s)	T_L	260	°C

(1) Isolation surge voltage, V_{ISO} , is an internal device dielectric breakdown rating. For this test, Pins 1 and 2 are common, and Pins 4, 5 and 6 are common.

(2) Refer to Quality and Reliability Section for test information.

MOC3031*

[IFT = 15 mA Max]

MOC3032

[IFT = 10 mA Max]

MOC3033

[IFT = 5 mA Max]

*Motorola Preferred Device
STYLE 6 PLASTIC



STANDARD THRU HOLE
CASE 730A-04



"T" LEADFORM
WIDE SPACED 0.4"
CASE 730D-05



"S"/"F" LEADFORM
SURFACE MOUNT
CASE 730C-04
(STANDARD PROFILE)



CASE 730F-04
(LOW PROFILE)

COUPLER SCHEMATIC

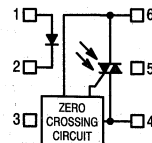

1. ANODE
2. CATHODE
3. NC
4. MAIN TERMINAL
5. SUBSTRATE
DO NOT CONNECT
6. MAIN TERMINAL

MOC3031, MOC3032, MOC3033

ELECTRICAL CHARACTERISTICS ($T_A = 25^\circ\text{C}$ unless otherwise noted)

Characteristic	Symbol	Min	Typ	Max	Unit
----------------	--------	-----	-----	-----	------

INPUT LED

Reverse Leakage Current ($V_R = 3\text{ V}$)	I_R	—	0.05	100	μA
Forward Voltage ($I_F = 30\text{ mA}$)	V_F	—	1.3	1.5	Volts

OUTPUT DETECTOR ($I_F = 0$ unless otherwise noted)

Leakage with LED Off, Either Direction (Rated V_{DRM} , Note 1)	I_{DRM1}	—	10	100	nA
Peak On-State Voltage, Either Direction ($I_{TM} = 100\text{ mA Peak}$)	V_{TM}	—	1.8	3	Volts
Critical Rate of Rise of Off-State Voltage	dv/dt	1000	2000	—	$\text{V}/\mu\text{s}$

COUPLED

LED Trigger Current, Current Required to Latch Output (Main Terminal Voltage = 3 V, Note 2)	I_{FT}	—	—	15	mA
MOC3031		—	—	10	
MOC3032		—	—	5	
MOC3033		—	—		
Holding Current, Either Direction	I_H	—	100	—	μA
Isolation Voltage ($f = 60\text{ Hz}$, $t = 1\text{ sec}$)	V_{ISO}	7500	—	—	Vac(pk)

ZERO CROSSING

Inhibit Voltage ($I_F = \text{Rated } I_{FT}$, MT1-MT2 Voltage above which device will not trigger.)	V_{IH}	—	5	20	Volts
Leakage in Inhibited State ($I_F = \text{Rated } I_{FT}$, Rated V_{DRM} , Off State)	I_{DRM2}	—	—	500	μA

Notes: 1. Test voltage must be applied within dv/dt rating.

2. All devices are guaranteed to trigger at an I_F value less than or equal to max I_{FT} . Therefore, recommended operating I_F lies between max I_{FT} (15 mA for MOC3031, 10 mA for MOC3032, 5 mA for MOC3033) and absolute max I_F (60 mA).

TYPICAL ELECTRICAL CHARACTERISTICS

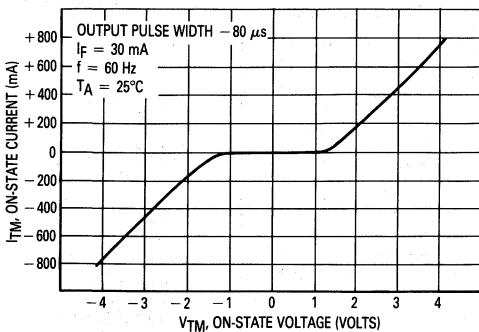

Figure 1. On-State Characteristics

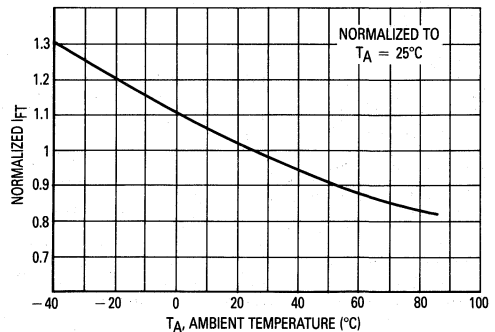

Figure 2. Trigger Current versus Temperature

MOC3031, MOC3032, MOC3033

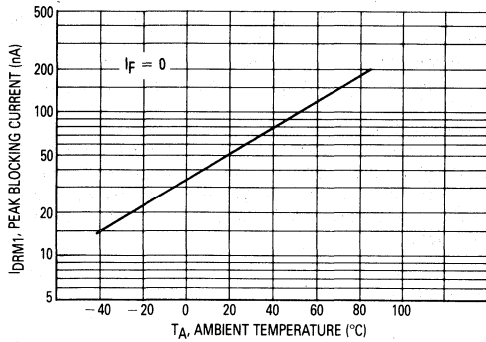

Figure 3. I_{DRM1}, Peak Blocking Current versus Temperature

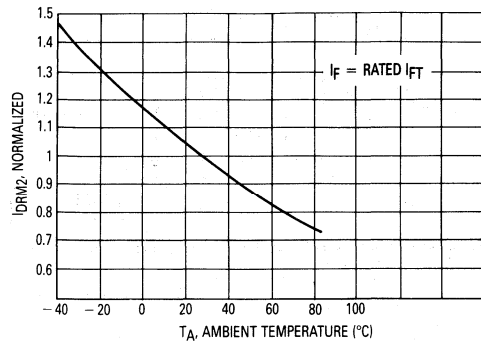

Figure 4. I_{DRM2}, Leakage in Inhibit State versus Temperature

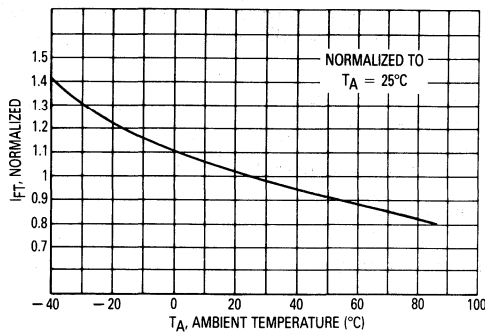

Figure 5. Trigger Current versus Temperature

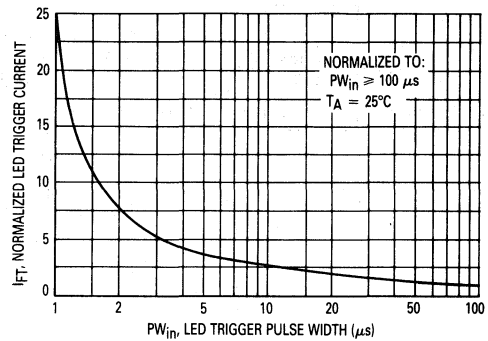

Figure 6. LED Current Required to Trigger versus LED Pulse Width

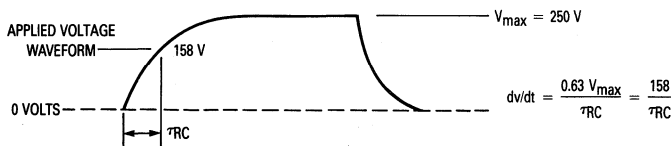
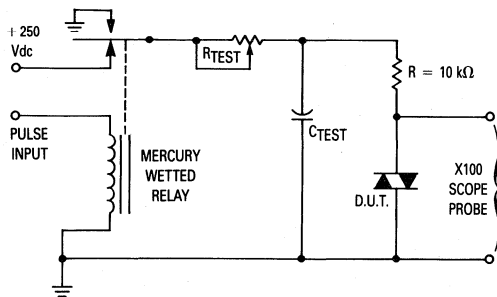
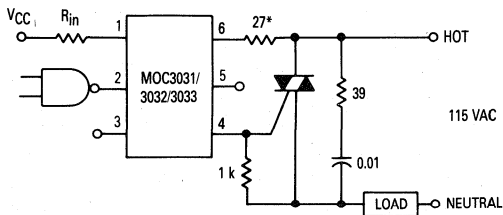

Figure 7. Static dv/dt Test Circuit

1. The mercury wetted relay provides a high speed repeated pulse to the D.U.T.
2. 100x scope probes are used, to allow high speeds and voltages.
3. The worst-case condition for static dv/dt is established by triggering the D.U.T. with a normal LED input current, then removing the current. The variable R_{TEST} allows the dv/dt to be gradually increased until the D.U.T. continues to trigger in response to the applied voltage pulse, even after the LED current has been removed. The dv/dt is then decreased until the D.U.T. stops triggering. τ_{RC} is measured at this point and recorded.

MOC3031, MOC3032, MOC3033



Typical circuit for use when hot line switching is required. In this circuit the "hot" side of the line is switched and the load connected to the cold or neutral side. The load may be connected to either the neutral or hot line.

R_{in} is calculated so that I_F is equal to the rated I_{FT} of the part, 5 mA for the MOC3033, 10 mA for the MOC3032, or 15 mA for the MOC3031. The 39 ohm resistor and 0.01 μ F capacitor are for snubbing of the triac and may or may not be necessary depending upon the particular triac and load used.

*For highly inductive loads (power factor < 0.5), change this value to 360 ohms.

Figure 8. Hot-Line Switching Application Circuit

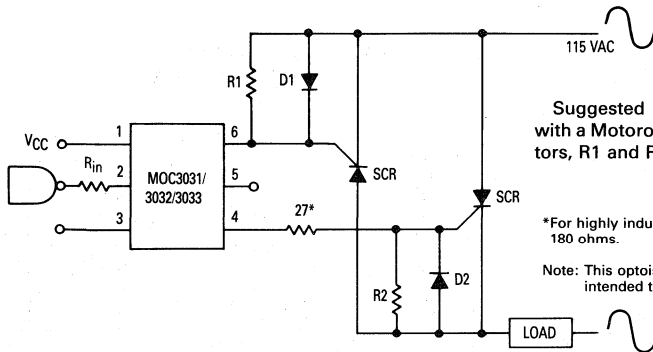

Suggested method of firing two, back-to-back SCR's, with a Motorola triac driver. Diodes can be 1N4001; resistors, R1 and R2, are optional 1 k ohm.

*For highly inductive loads (power factor < 0.5), change this value to 180 ohms.

Note: This optoisolator should not be used to drive a load directly. It is intended to be a trigger device only.

Figure 9. Inverse-Parallel SCR Driver Circuit



6-Pin DIP Optoisolators Triac Driver Output (400 Volts)

The MOC3041, MOC3042 and MOC3043 devices consist of gallium arsenide infrared emitting diodes optically coupled to a monolithic silicon detector performing the function of a Zero Voltage Crossing bilateral triac driver.

They are designed for use with a triac in the interface of logic systems to equipment powered from 115 Vac lines, such as solid-state relays, industrial controls, motors, solenoids and consumer appliances, etc.

- Simplifies Logic Control of 115 Vac Power
- Zero Voltage Crossing
- dv/dt of 2000 V/ μ s Typical, 1000 V/ μ s Guaranteed

Applications

- Solenoid/Valve Controls
- Lighting Controls
- Static Power Switches
- AC Motor Drives
- Temperature Controls
- E.M. Contactors
- AC Motor Starters
- Solid State Relays

MAXIMUM RATINGS ($T_A = 25^\circ\text{C}$ unless otherwise noted)

Rating	Symbol	Value	Unit
--------	--------	-------	------

INFRARED EMITTING DIODE

Reverse Voltage	V_R	6	Volts
Forward Current — Continuous	I_F	60	mA
Total Power Dissipation @ $T_A = 25^\circ\text{C}$ Negligible Power in Output Driver Derate above 25°C	P_D	120	mW
		1.41	mW/ $^\circ\text{C}$

OUTPUT DRIVER

Off-State Output Terminal Voltage	V_{DRM}	400	Volts
Peak Repetitive Surge Current ($PW = 100 \mu\text{s}$, 120 pps)	I_{TSM}	1	A
Total Power Dissipation @ $T_A = 25^\circ\text{C}$ Derate above 25°C	P_D	150	mW
		1.76	mW/ $^\circ\text{C}$

TOTAL DEVICE

Isolation Surge Voltage (1) (Peak ac Voltage, 60 Hz, 1 Second Duration)	V_{ISO}	7500	Vac
Total Power Dissipation @ $T_A = 25^\circ\text{C}$ Derate above 25°C	P_D	250 2.94	mW mW/ $^\circ\text{C}$
Junction Temperature Range	T_J	-40 to +100	$^\circ\text{C}$
Ambient Operating Temperature Range (2)	T_A	-40 to +85	$^\circ\text{C}$
Storage Temperature Range	T_{stg}	-40 to +150	$^\circ\text{C}$
Soldering Temperature (10 s)	T_L	260	$^\circ\text{C}$

(1) Isolation surge voltage, V_{ISO} , is an internal device dielectric breakdown rating. For this test, Pins 1 and 2 are common, and Pins 4, 5 and 6 are common.

(2) Refer to Quality and Reliability Section for test information.

MOC3041*

[IFT = 15 mA Max]

MOC3042

[IFT = 10 mA Max]

MOC3043*

[IFT = 5 mA Max]

*Motorola Preferred Devices
 STYLE 6 PLASTIC



STANDARD THRU HOLE
 CASE 730A-04



"T" LEADFORM
 WIDE SPACED 0.4"
 CASE 730D-05



"S"/"F" LEADFORM
 SURFACE MOUNT
 CASE 730C-04
 (STANDARD PROFILE)



CASE 730F-04
 (LOW PROFILE)

COUPLER SCHEMATIC

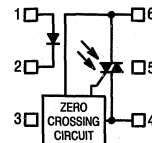

1. ANODE
2. CATHODE
3. NC
4. MAIN TERMINAL
5. SUBSTRATE
DO NOT CONNECT
6. MAIN TERMINAL

MOC3041, MOC3042, MOC3043

ELECTRICAL CHARACTERISTICS ($T_A = 25^\circ\text{C}$ unless otherwise noted)

Characteristic	Symbol	Min	Typ	Max	Unit
----------------	--------	-----	-----	-----	------

INPUT LED

Reverse Leakage Current ($V_R = 6\text{ V}$)	I_R	—	0.05	100	μA
Forward Voltage ($I_F = 30\text{ mA}$)	V_F	—	1.3	1.5	Volts

OUTPUT DETECTOR ($I_F = 0$ unless otherwise noted)

Leakage with LED Off, Either Direction (Rated V_{DRM} , Note 1)	I_{DRM1}	—	2	100	nA
Peak On-State Voltage, Either Direction ($I_{TM} = 100\text{ mA Peak}$)	V_{TM}	—	1.8	3	Volts
Critical Rate of Rise of Off-State Voltage (Note 3)	dv/dt	1000	2000	—	$\text{V}/\mu\text{s}$

COUPLED

LED Trigger Current, Current Required to Latch Output (Main Terminal Voltage = 3 V, Note 2)	I_{FT}	—	—	15	mA
	MOC3041	—	—	10	
	MOC3042	—	—	5	
	MOC3043	—	—	5	
Holding Current, Either Direction	I_H	—	100	—	μA
Isolation Voltage ($f = 60\text{ Hz}$, $t = 1\text{ sec}$)	V_{ISO}	7500	—	—	Vac(pk)

ZERO CROSSING

Inhibit Voltage ($I_F = \text{Rated } I_{FT}$, MT1-MT2 Voltage above which device will not trigger.)	V_{IH}	—	5	20	Volts
Leakage in Inhibited State ($I_F = \text{Rated } I_{FT}$, Rated V_{DRM} , Off State)	I_{DRM2}	—	—	500	μA

Notes: 1. Test voltage must be applied within dv/dt rating.

2. All devices are guaranteed to trigger at an I_F value less than or equal to max I_{FT} . Therefore, recommended operating I_F lies between max I_{FT} (15 mA for MOC3041, 10 mA for MOC3042, 5 mA for MOC3043) and absolute max I_F (60 mA).

3. This is static dv/dt. See Figure 7 for test circuit. Commutating dv/dt is a function of the load-driving thyristor(s) only.

TYPICAL ELECTRICAL CHARACTERISTICS

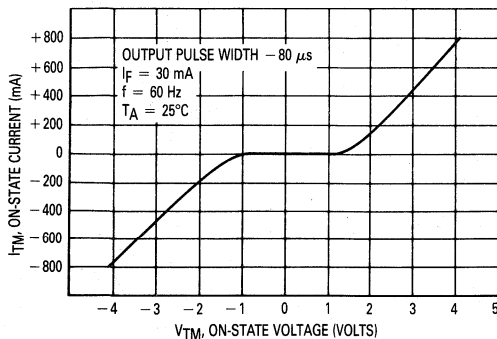

Figure 1. On-State Characteristics

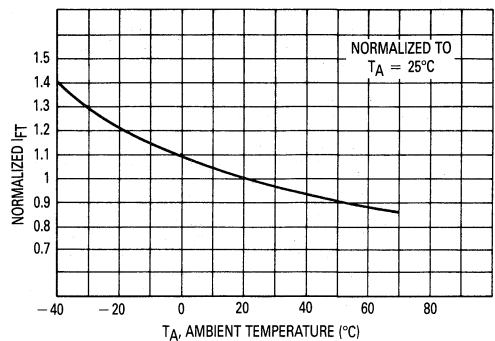

Figure 2. Trigger Current versus Temperature

MOC3041, MOC3042, MOC3043

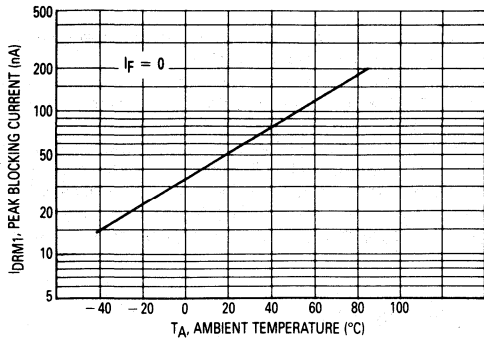

Figure 3. IDRM1, Peak Blocking Current versus Temperature

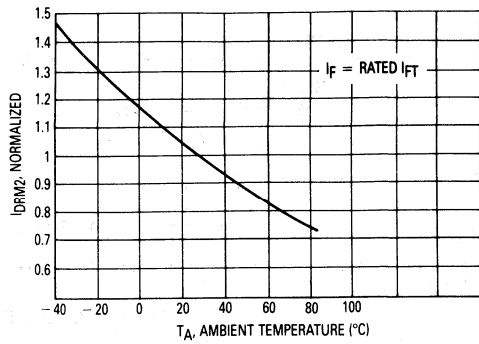

Figure 4. IDRM2, Leakage in Inhibit State versus Temperature

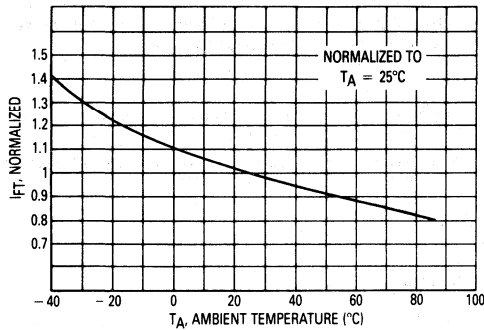

Figure 5. Trigger Current versus Temperature

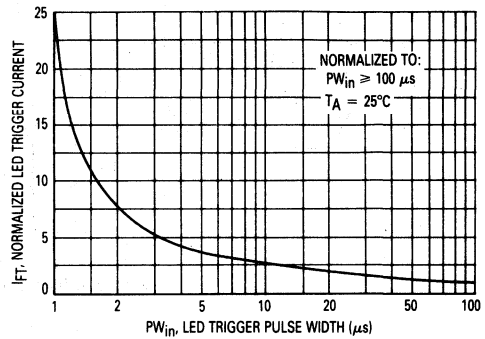

Figure 6. LED Current Required to Trigger versus LED Pulse Width

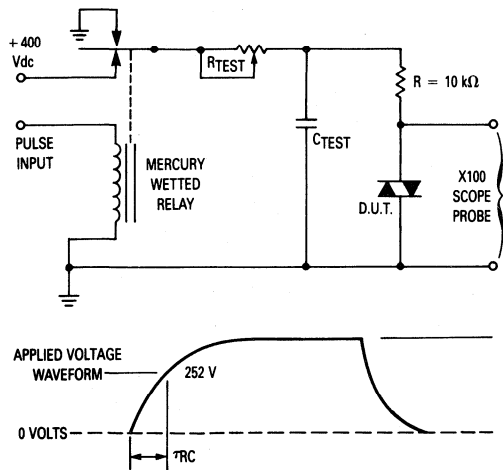
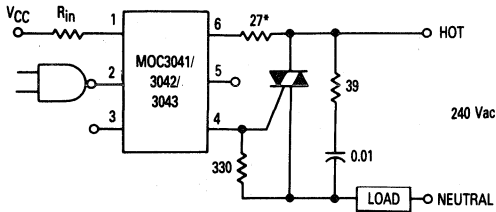

Figure 7. Static dv/dt Test Circuit

MOC3041, MOC3042, MOC3043



Typical circuit for use when hot line switching is required. In this circuit the "hot" side of the line is switched and the load connected to the cold or neutral side. The load may be connected to either the neutral or hot line.

R_{in} is calculated so that I_F is equal to the rated I_{FT} of the part, 5 mA for the MOC3043, 10 mA for the MOC3042, or 15 mA for the MOC3041. The 39 ohm resistor and 0.01 μ F capacitor are for snubbing of the triac and may or may not be necessary depending upon the particular triac and load used.

*For highly inductive loads (power factor < 0.5), change this value to 360 ohms.

Figure 8. Hot-Line Switching Application Circuit

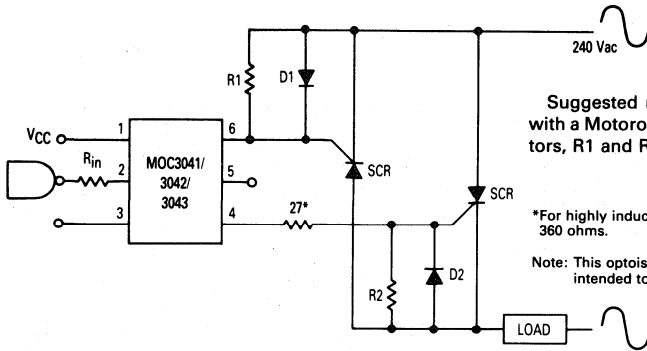

Suggested method of firing two, back-to-back SCR's, with a Motorola triac driver. Diodes can be 1N4001; resistors, R1 and R2, are optional 330 ohms.

*For highly inductive loads (power factor < 0.5), change this value to 360 ohms.

Note: This optoisolator should not be used to drive a load directly. It is intended to be a trigger device only.

Figure 9. Inverse-Parallel SCR Driver Circuit

MOTOROLA SEMICONDUCTOR TECHNICAL DATA



6-Pin DIP Optoisolators Triac Driver Output (600 Volts)

The MOC3061, MOC3062 and MOC3063 devices consist of gallium arsenide infrared emitting diodes optically coupled to monolithic silicon detectors performing the functions of Zero Voltage Crossing bilateral triac drivers.

They are designed for use with a triac in the interface of logic systems to equipment powered from 240 Vac lines, such as solid-state relays, industrial controls, motors, solenoids and consumer appliances, etc.

- Simplifies Logic Control of 240 Vac Power
- Zero Voltage Crossing
- dv/dt of 1500 V/ μ s Typical, 600 V/ μ s Guaranteed

Applications

- Solenoid/Valve Controls
- Lighting Controls
- Static Power Switches
- AC Motor Drives
- Temperature Controls
- E.M. Contactors
- AC Motor Starters
- Solid State Relays

MAXIMUM RATINGS

Rating	Symbol	Value	Unit
--------	--------	-------	------

INFRARED EMITTING DIODE

Reverse Voltage	V_R	6	Volts
Forward Current — Continuous	I_F	60	mA
Total Power Dissipation @ $T_A = 25^\circ\text{C}$ Negligible Power in Output Driver Derate above 25°C	P_D	120	mW
		1.41	mW/ $^\circ\text{C}$

OUTPUT DRIVER

Off-State Output Terminal Voltage	V_{DRM}	600	Volts
Peak Repetitive Surge Current ($PW = 100 \mu\text{s}$, 120 pps)	I_{TSM}	1	A
Total Power Dissipation @ $T_A = 25^\circ\text{C}$ Derate above 25°C	P_D	150	mW
		1.76	mW/ $^\circ\text{C}$

TOTAL DEVICE

Isolation Surge Voltage (1) (Peak ac Voltage, 60 Hz, 1 Second Duration)	V_{ISO}	7500	Vac
Total Power Dissipation @ $T_A = 25^\circ\text{C}$ Derate above 25°C	P_D	250	mW
		2.94	mW/ $^\circ\text{C}$
Junction Temperature Range	T_J	-40 to +100	$^\circ\text{C}$
Ambient Operating Temperature Range (2)	T_A	-40 to +85	$^\circ\text{C}$
Storage Temperature Range	T_{stg}	-40 to +150	$^\circ\text{C}$
Soldering Temperature (10 s)	T_L	260	$^\circ\text{C}$

(1) Isolation surge voltage, V_{ISO} , is an internal device dielectric breakdown rating. For this test, Pins 1 and 2 are common, and Pins 4, 5 and 6 are common.

(2) Refer to Quality and Reliability Section for test information.

MOC3061
[IFT = 15 mA Max]
MOC3062
[IFT = 10 mA Max]
MOC3063*
[IFT = 5 mA Max]
*Motorola Preferred Device
STYLE 6 PLASTIC



STANDARD THRU HOLE
CASE 730A-04



"T" LEADFORM
WIDE SPACED 0.4"
CASE 730D-05



"S"/"F" LEADFORM
SURFACE MOUNT
CASE 730C-04
(STANDARD PROFILE)



CASE 730F-04
(LOW PROFILE)

COUPLER SCHEMATIC

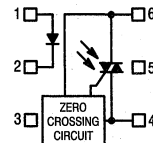

1. ANODE
2. CATHODE
3. NC
4. MAIN TERMINAL
5. SUBSTRATE
DO NOT CONNECT
6. MAIN TERMINAL

MOC3061, MOC3062, MOC3063

ELECTRICAL CHARACTERISTICS (T_A = 25°C unless otherwise noted)

Characteristic	Symbol	Min	Typ	Max	Unit
INPUT LED					
Reverse Leakage Current (V _R = 6 V)	I _R	—	0.05	100	μA
Forward Voltage (I _F = 30 mA)	V _F	—	1.3	1.5	Volts
OUTPUT DETECTOR (I_F = 0)					
Leakage with LED Off, Either Direction (Rated V _{DRM} , Note 1)	I _{DRM1}	—	60	500	nA
Critical Rate of Rise of Off-State Voltage (Note 3)	dv/dt	600	1500	—	V/μs
COUPLED					
LED Trigger Current, Current Required to Latch Output (Main Terminal Voltage = 3 V, Note 2)	I _{FT}	—	—	15 10 5	mA
					MOC3061
					MOC3062
					MOC3063
Peak On-State Voltage, Either Direction (I _{TM} = 100 mA, I _F = Rated I _{FT})	V _{TM}	—	1.8	3	Volts
Holding Current, Either Direction	I _H	—	100	—	μA
Inhibit Voltage (MT1-MT2 Voltage above which device will not trigger.) (I _F = Rated I _{FT})	V _{INH}	—	5	20	Volts
Leakage in Inhibited State (I _F = Rated I _{FT} , Rated V _{DRM} , Off State)	I _{DRM2}	—	—	500	μA
Isolation Voltage (f = 60 Hz, t = 1 sec)	V _{ISO}	7500	—	—	Vac(pk)

Notes: 1. Test voltage must be applied within dv/dt rating.

2. All devices are guaranteed to trigger at an I_F value less than or equal to max I_{FT}. Therefore, recommended operating I_F lies between max I_{FT} (15 mA for MOC3061, 10 mA for MOC3062, 5 mA for MOC3063) and absolute max I_F (60 mA).

3. This is static dv/dt. See Figure 7 for test circuit. Commutating dv/dt is a function of the load-driving thyristor(s) only.

TYPICAL CHARACTERISTICS

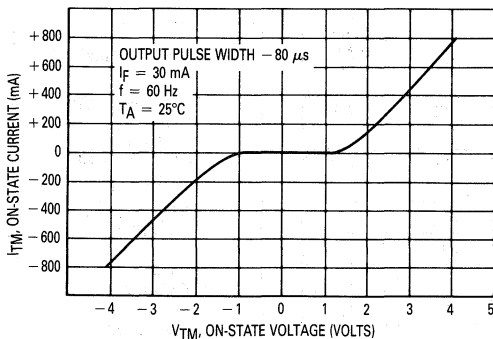

Figure 1. On-State Characteristics

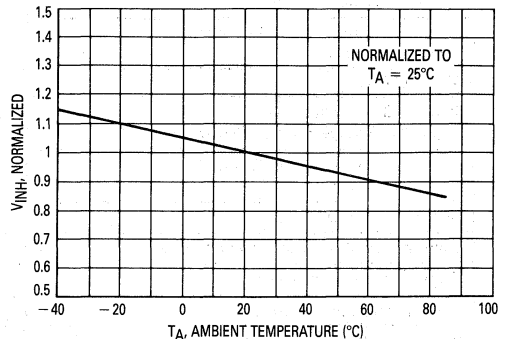

Figure 2. Inhibit Voltage versus Temperature

MOC3061, MOC3062, MOC3063

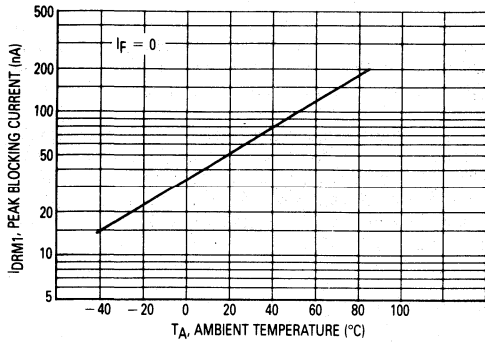

Figure 3. Leakage with LED Off versus Temperature

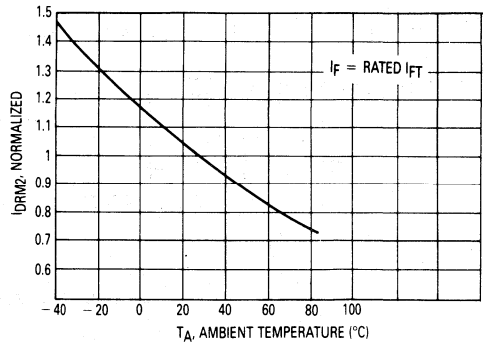

Figure 4. IDRM2, Leakage in Inhibit State versus Temperature

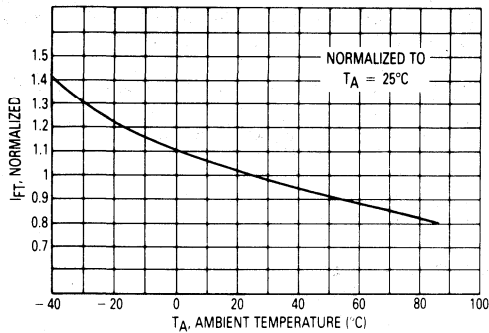

Figure 5. Trigger Current versus Temperature

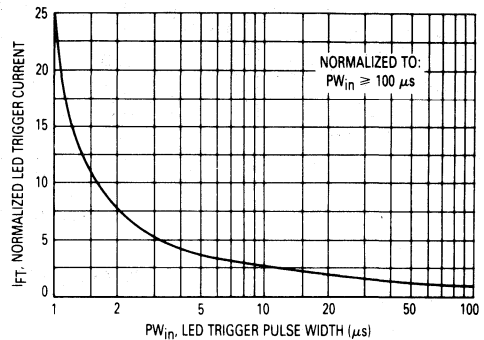
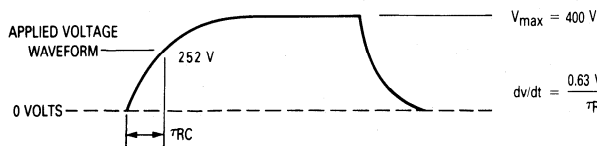
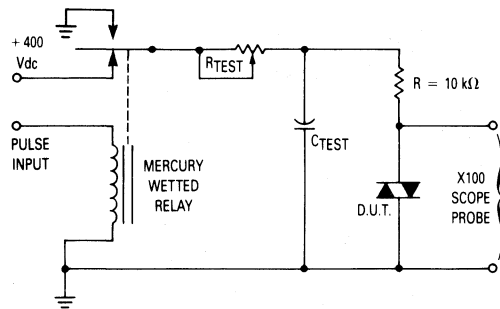

Figure 6. LED Current Required to Trigger versus LED Pulse Width



1. The mercury wetted relay provides a high speed repeated pulse to the D.U.T.
2. 100x scope probes are used, to allow high speeds and voltages.
3. The worst-case condition for static dv/dt is established by triggering the D.U.T. with a normal LED input current, then removing the current. The variable R_{TEST} allows the dv/dt to be gradually increased until the D.U.T. continues to trigger in response to the applied voltage pulse, even after the LED current has been removed. The dv/dt is then decreased until the D.U.T. stops triggering. τ_{RC} is measured at this point and recorded.

$$dv/dt = \frac{0.63 V_{max}}{\tau RC} = \frac{378}{\tau RC}$$

Figure 7. Static dv/dt Test Circuit

MOC3061, MOC3062, MOC3063

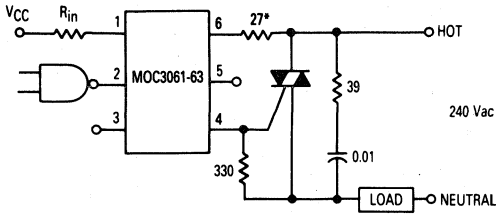

Typical circuit for use when hot line switching is required. In this circuit the "hot" side of the line is switched and the load connected to the cold or neutral side. The load may be connected to either the neutral or hot line.

R_{in} is calculated so that I_F is equal to the rated I_{FT} of the part, 15 mA for the MOC3061, 10 mA for the MOC3062, and 5 mA for the MOC3063. The 39 ohm resistor and 0.01 μ F capacitor are for snubbing of the triac and may or may not be necessary depending upon the particular triac and load used.

Figure 8. Hot-Line Switching Application Circuit

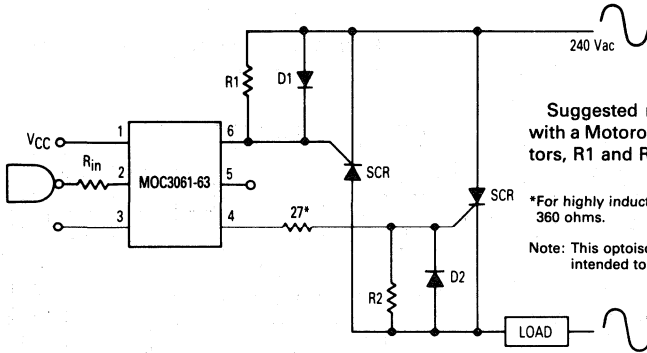

Suggested method of firing two, back-to-back SCR's, with a Motorola triac driver. Diodes can be 1N4001; resistors, R1 and R2, are optional 330 ohms.

*For highly inductive loads (power factor < 0.5), change this value to 360 ohms.

Note: This optoisolator should not be used to drive a load directly. It is intended to be a trigger device only.

Figure 9. Inverse-Parallel SCR Driver Circuit

4



6-Pin DIP Optoisolators Triac Driver Output (800 Volts)

The MOC3081, MOC3082 and MOC3083 devices consist of gallium arsenide infrared emitting diodes optically coupled to monolithic silicon detectors performing the function of Zero Voltage Crossing bilateral triac drivers.

They are designed for use with a triac in the interface of logic systems to equipment powered from 240 Vac lines, such as solid-state relays, industrial controls, motors, solenoids and consumer appliances, etc.

- Simplifies Logic Control of 240 Vac Power
- Zero Voltage Crossing
- dv/dt of 1500 V/μs Typical, 600 V/μs Guaranteed

Applications

- Solenoid/Valve Controls
- Lighting Controls
- Static Power Switches
- AC Motor Drives
- Temperature Controls
- E.M. Contactors
- AC Motor Starters
- Solid State Relays

MAXIMUM RATINGS

Rating	Symbol	Value	Unit
INPUT LED			
Reverse Voltage	V_R	6	Volts
Forward Current — Continuous	I_F	60	mA
Total Power Dissipation @ $T_A = 25^\circ\text{C}$ Negligible Power in Output Driver Derate above 25°C	P_D	120	mW
		1.41	mW/°C
OUTPUT DRIVER			
Off-State Output Terminal Voltage	V_{DRM}	800	Volts
Peak Repetitive Surge Current (PW = 100 μs, 120 pps)	I_{TSM}	1	A
Total Power Dissipation @ $T_A = 25^\circ\text{C}$ Derate above 25°C	P_D	150	mW
		1.76	mW/°C
TOTAL DEVICE			
Isolation Surge Voltage (1) (Peak ac Voltage, 60 Hz, 1 Second Duration)	V_{ISO}	7500	Vac
Total Power Dissipation @ $T_A = 25^\circ\text{C}$ Derate above 25°C	P_D	250	mW
		2.94	mW/°C
Junction Temperature Range	T_J	-40 to +100	°C
Ambient Operating Temperature Range (2)	T_A	-40 to +85	°C
Storage Temperature Range	T_{stg}	-40 to +150	°C
Soldering Temperature (10 s)	T_L	260	°C

(1) Isolation surge voltage, V_{ISO} , is an internal device dielectric breakdown rating. For this test, Pins 1 and 2 are common, and Pins 4, 5 and 6 are common.

(2) Refer to Quality and Reliability Section for test information.

MOC3081
 [IFT = 15 mA Max]
MOC3082
 [IFT = 10 mA Max]
MOC3083
 [IFT = 5 mA Max]
STYLE 6 PLASTIC



STANDARD THRU HOLE
CASE 730A-04



"T" LEADFORM
WIDE SPACED 0.4"
CASE 730D-05



"S"/"F" LEADFORM
SURFACE MOUNT
CASE 730C-04
(STANDARD PROFILE)



CASE 730F-04
(LOW PROFILE)

4

COUPLER SCHEMATIC

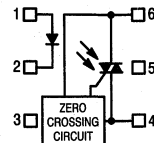

1. ANODE
2. CATHODE
3. NC
4. MAIN TERMINAL
5. SUBSTRATE
DO NOT CONNECT
6. MAIN TERMINAL

MOC3081, MOC3082, MOC3083

ELECTRICAL CHARACTERISTICS ($T_A = 25^\circ\text{C}$ unless otherwise noted)

Characteristic	Symbol	Min	Typ	Max	Unit
INPUT LED					
Reverse Leakage Current ($V_R = 6\text{ V}$)	I_R	—	0.05	100	μA
Forward Voltage ($I_F = 30\text{ mA}$)	V_F	—	1.3	1.5	Volts
OUTPUT DETECTOR ($I_F = 0$)					
Leakage with LED Off, Either Direction ($V_{DRM} = 800\text{ V}$, Note 1)	I_{DRM1}	—	80	500	nA
Critical Rate of Rise of Off-State Voltage (Note 3)	dv/dt	600	1500	—	V/ μs

COUPLED

LED Trigger Current, Current Required to Latch Output (Main Terminal Voltage = 3 V, Note 2)	I_{FT}	—	—	15	mA
MOC3081	—	—	—	10	
MOC3082	—	—	—	5	
MOC3083	—	—	—	—	
Peak On-State Voltage, Either Direction ($I_{TM} = 100\text{ mA}$, $I_F = \text{Rated } I_{FT}$)	V_{TM}	—	1.8	3	Volts
Holding Current, Either Direction	I_H	—	100	—	μA
Inhibit Voltage (MT1-MT2 Voltage above which device will not trigger) ($I_F = \text{Rated } I_{FT}$)	V_{INH}	—	5	20	Volts
Leakage in Inhibited State ($I_F = \text{Rated } I_{FT}$, $V_{DRM} = 800\text{ V}$, Off State)	I_{DRM2}	—	300	500	μA

Notes: 1. Test voltage must be applied within dv/dt rating.

2. All devices are guaranteed to trigger at an I_F value less than or equal to max I_{FT} . Therefore, recommended operating I_F lies between max I_{FT} (15 mA for MOC3081, 10 mA for MOC3082, 5 mA for MOC3083) and absolute max I_F (60 mA).

3. This is static dv/dt. See Figure 7 for test circuit. Commutating dv/dt is a function of the load-driving thyristor(s) only.

TYPICAL CHARACTERISTICS

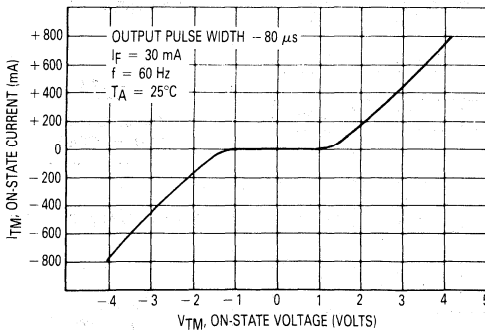

Figure 1. On-State Characteristics

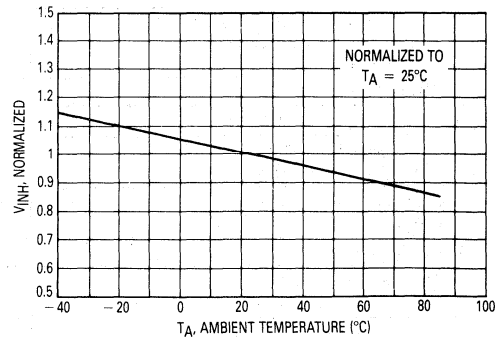

Figure 2. Inhibit Voltage versus Temperature

MOC3081, MOC3082, MOC3083

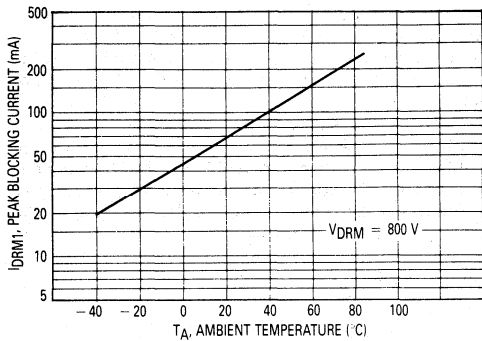

Figure 3. Leakage with LED Off versus Temperature

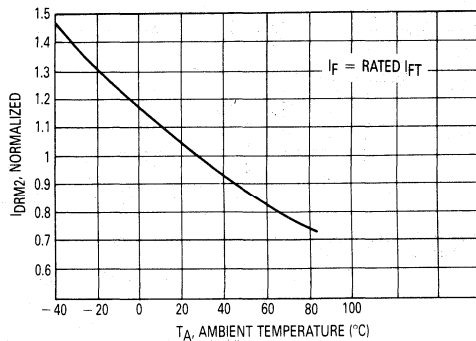

Figure 4. IDRM2, Leakage in Inhibit State versus Temperature

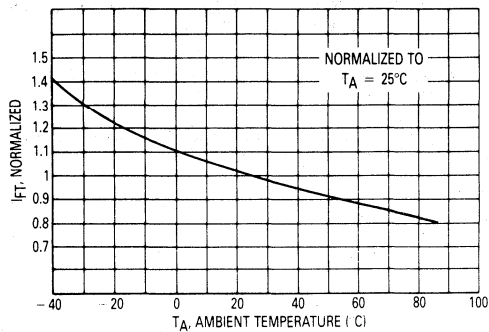

Figure 5. Trigger Current versus Temperature

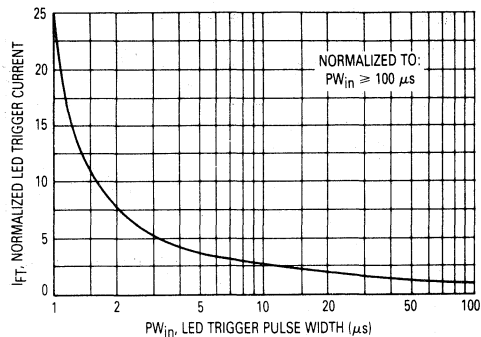
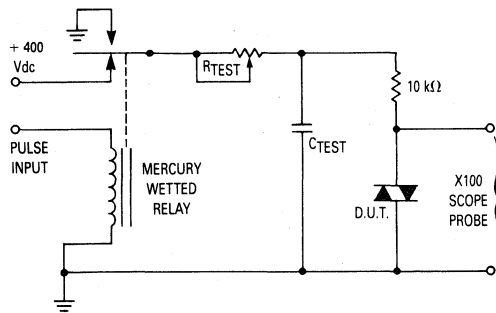

Figure 6. LED Current Required to Trigger versus LED Pulse Width



1. The mercury wetted relay provides a high speed repeated pulse to the D.U.T.
2. 100x scope probes are used, to allow high speeds and voltages.
3. The worst-case condition for static dv/dt is established by triggering the D.U.T. with a normal LED input current, then removing the current. The variable R_{TEST} allows the dv/dt to be gradually increased until the D.U.T. continues to trigger in response to the applied voltage pulse, even after the LED current has been removed. The dv/dt is then decreased until the D.U.T. stops triggering. τ_{RC} is measured at this point and recorded.

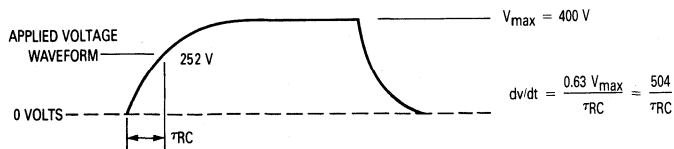
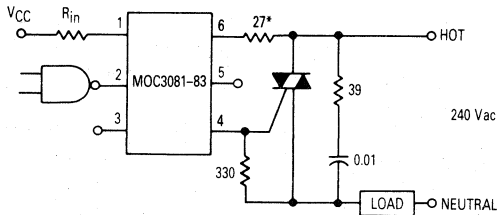

Figure 7. Static dv/dt Test Circuit

MOC3081, MOC3082, MOC3083



Typical circuit for use when hot line switching is required. In this circuit the "hot" side of the line is switched and the load connected to the cold or neutral side. The load may be connected to either the neutral or hot line.

R_{in} is calculated so that I_F is equal to the rated I_{FT} of the part, 15 mA for the MOC3081, 10 mA for the MOC3082, and 5 mA for the MOC3083. The 39 ohm resistor and 0.01 μ F capacitor are for snubbing of the triac and may or may not be necessary depending upon the particular triac and load used.

*For highly inductive loads (power factor < 0.5), change this value to 360 ohms.

Figure 8. Hot-Line Switching Application Circuit

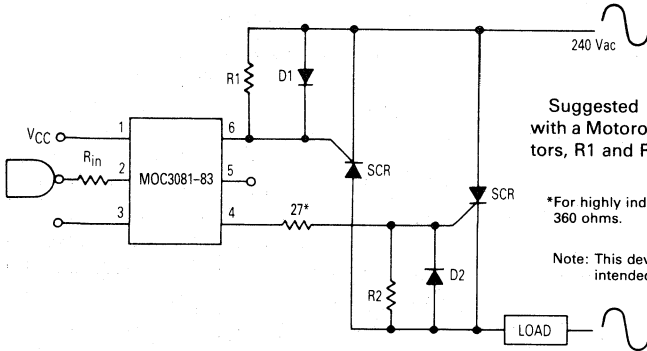

Suggested method of firing two, back-to-back SCR's, with a Motorola triac driver. Diodes can be 1N4001; resistors, R1 and R2, are optional 330 ohms.

*For highly inductive loads (power factor < 0.5), change this value to 360 ohms.

Note: This device should not be used to drive a load directly. It is intended to be a trigger device only.

Figure 9. Inverse-Parallel SCR Driver Circuit

4

MOTOROLA SEMICONDUCTOR TECHNICAL DATA



6-Pin DIP Optoisolators Logic Output

The MOC5007, MOC5008 and MOC5009 have a gallium arsenide IRED optically coupled to a high-speed integrated detector with Schmitt trigger output. Designed for applications requiring electrical isolation, fast response time, noise immunity and digital logic compatibility.

- Guaranteed Switching Times — t_{on} , $t_{off} < 4 \mu s$
- Built-In ON/OFF Threshold Hysteresis
- High Data Rate, 1 MHz Typical (NRZ)
- Wide Supply Voltage Capability
- Microprocessor Compatible Drive

Applications

- Interfacing Computer Terminals to Peripheral Equipment
- Digital Control of Power Supplies
- Line Receiver — Eliminates Noise
- Digital Control of Motors and Other Servo Machine Applications
- Logic to Logic Isolator
- Logic Level Shifter — Couples TTL to CMOS

MAXIMUM RATINGS ($T_A = 25^\circ C$ unless otherwise noted)

Rating	Symbol	Value	Unit
--------	--------	-------	------

INPUT LED

Reverse Voltage	V_R	6	Volts
Forward Current — Continuous Peak Pulse Width = 300 μs , 2% Duty Cycle	I_F	60 1.2	mA Amp
LED Power Dissipation @ $T_A = 25^\circ C$ Derate above 25 $^\circ C$	P_D	120 1.41	mW mW/ $^\circ C$

OUTPUT DETECTOR

Output Voltage Range	V_O	0–16	Volts
Supply Voltage Range	V_{CC}	3–16	Volts
Output Current	I_O	50	mA
Detector Power Dissipation @ $T_A = 25^\circ C$ Derate above 25 $^\circ C$	P_D	150 1.76	mW mW/ $^\circ C$

TOTAL DEVICE

Total Device Power Dissipation @ $T_A = 25^\circ C$ Derate above 25 $^\circ C$	P_D	250 2.94	mW mW/ $^\circ C$
Maximum Operating Temperature (2)	T_A	–40 to +85	$^\circ C$
Storage Temperature Range	T_{stg}	–55 to +150	$^\circ C$
Soldering Temperature (10 s)	T_L	260	$^\circ C$
Isolation Surge Voltage (1) (Peak ac Voltage, 60 Hz, 1 Second Duration)	V_{ISO}	7500	Volts

(1) Isolation surge voltage is an internal device dielectric breakdown rating. For this test, Pins 1 and 2 are common, and Pins 4, 5 and 6 are common.

(2) Refer to Quality and Reliability Section for test information.

MOC5007*

[$I_F(\text{on}) = 1.6 \text{ mA Max}$]

MOC5008

[$I_F(\text{on}) = 4 \text{ mA Max}$]

MOC5009

[$I_F(\text{on}) = 10 \text{ mA Max}$]

*Motorola Preferred Device
STYLE 5 PLASTIC



STANDARD THRU HOLE
CASE 730A-04



"T" LEADFORM
WIDE SPACED 0.4"
CASE 730D-05



"S"/"F" LEADFORM
SURFACE MOUNT
CASE 730C-04
(STANDARD PROFILE)



CASE 730F-04
(LOW PROFILE)

SCHEMATIC

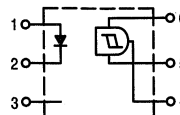

- PIN 1. ANODE
2. CATHODE
4. V_D
5. GROUND
6. V_{CC}

MOC5007, MOC5008, MOC5009

ELECTRICAL CHARACTERISTICS ($T_A = 0$ to 70°C)

Characteristic	Symbol	Min	Typ	Max	Unit
INPUT LED					
Reverse Leakage Current ($V_R = 3\text{ V}$, $R_L = 1\text{ M}\Omega$)	I_R	—	0.05	10	μA
Forward Voltage ($I_F = 10\text{ mA}$) ($I_F = 0.3\text{ mA}$)	V_F	— 0.75	1.2 0.95	1.5	Volts
Capacitance ($V_R = 0\text{ V}$, $f = 1\text{ MHz}$)	C	—	18	—	pF
OUTPUT DETECTOR					
Operating Voltage	V_{CC}	3	—	15	Volts
Supply Current ($I_F = 0$, $V_{CC} = 5\text{ V}$)	$I_{CC(\text{off})}$	—	1	5	mA
Output Current, High ($I_F = 0$, $V_{CC} = V_O = 15\text{ V}$)	I_{OH}	—	—	100	μA
COUPLED					
Supply Current ($I_F = I_{F(\text{on})}$, $V_{CC} = 5\text{ V}$)	$I_{CC(\text{on})}$	—	1.6	5	mA
Output Voltage, Low ($R_L = 270\ \Omega$, $V_{CC} = 5\text{ V}$, $I_F = I_{F(\text{on})}$)	V_{OL}	—	0.2	0.4	Volts
Threshold Current, ON ($R_L = 270\ \Omega$, $V_{CC} = 5\text{ V}$)	MOC5007	—	1	1.6	mA
	MOC5008	—	—	4	
	MOC5009	—	—	10	
Threshold Current, OFF ($R_L = 270\ \Omega$, $V_{CC} = 5\text{ V}$)	MOC5007	0.3	0.75	—	mA
	MOC5008, 5009	0.3	—	—	
Hysteresis Ratio ($R_L = 270\ \Omega$, $V_{CC} = 5\text{ V}$)	$\frac{I_{F(\text{off})}}{I_{F(\text{on})}}$	0.5	0.75	0.9	
Isolation Voltage (1) 60 Hz, AC Peak, 1 second, $T_A = 25^\circ\text{C}$	V_{ISO}	7500	—	—	Vac(pk)
Turn-On Time	$R_L = 270\ \Omega$ $V_{CC} = 5\text{ V}$, $I_F = I_{F(\text{on})}$ $T_A = 25^\circ\text{C}$	t_{on}	—	1.2	μs
Fall Time		t_f	—	0.1	
Turn-Off Time		t_{off}	—	1.2	
Rise Time		t_r	—	0.1	

(1) For this test IRED Pins 1 and 2 are common and Output Gate Pins 4, 5, 6 are common.

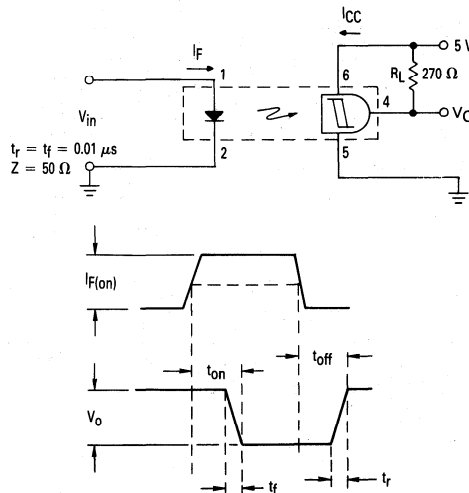

Figure 1. Switching Test Circuit

MOC5007, MOC5008, MOC5009

TYPICAL CHARACTERISTICS

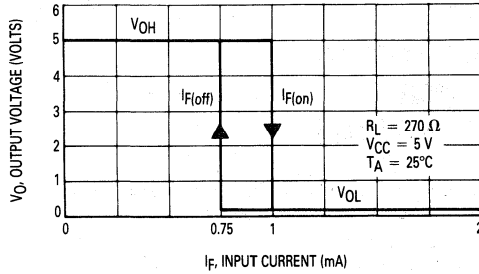

Figure 2. Transfer Characteristics for MOC5007

4

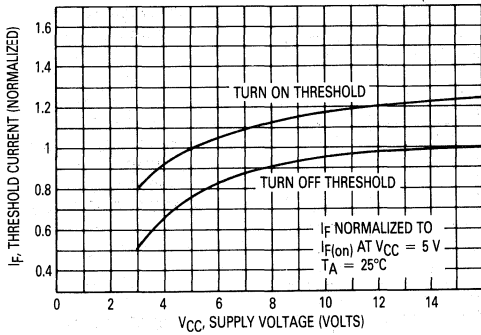

Figure 3. Threshold Current versus Supply Voltage

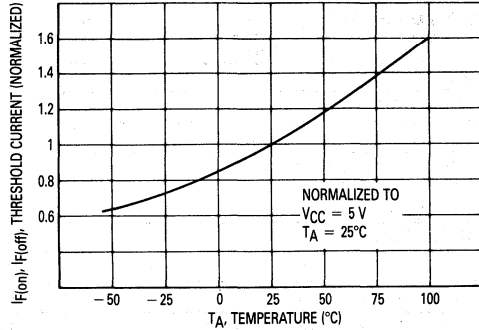

Figure 4. Threshold Current versus Temperature

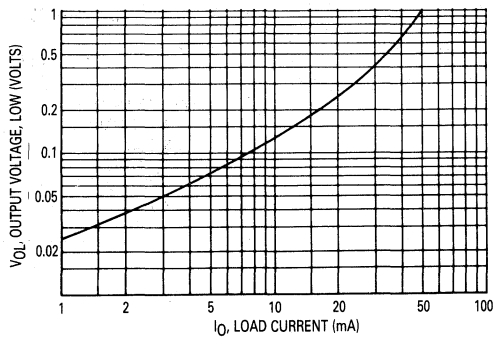

Figure 5. Output Voltage, Low versus Load Current

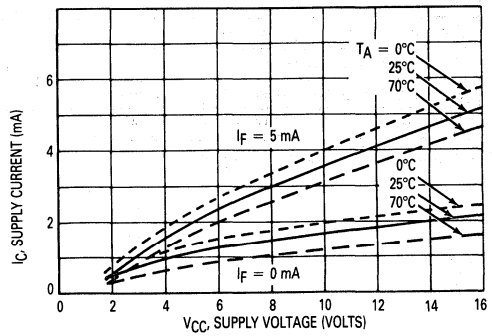
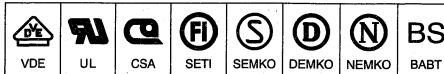

Figure 6. Supply Current versus Supply Voltage



6-Pin DIP Optoisolators Darlingtong Output (No Base Connection)

The MOC8020 and MOC8021 devices consist of a gallium arsenide infrared emitting diode optically coupled to a monolithic silicon photodarlington detector.

- No Base Connection for Improved Noise Immunity
- High Sensitivity to Low Input Drive Current

Applications

- Appliances, Measuring Instruments
- I/O Interfaces for Computers
- Programmable Controllers
- Portable Electronics
- Interfacing and coupling systems of different potentials and impedances
- Solid State Relays

MAXIMUM RATINGS (T_A = 25°C unless otherwise noted)

Rating	Symbol	Value	Unit
INPUT LED			
Reverse Voltage	V _R	3	Volts
Forward Current — Continuous	I _F	60	mA
LED Power Dissipation @ T _A = 25°C with Negligible Power in Output Detector Derate above 25°C	P _D	120	mW
		1.41	mW/°C
OUTPUT DETECTOR			
Collector-Emitter Voltage	V _{CEO}	50	Volts
Emitter-Collector Voltage	V _{ECO}	5	Volts
Detector Power Dissipation @ T _A = 25°C with Negligible Power in Input LED Derate above 25°C	P _D	150	mW
		1.76	mW/°C
TOTAL DEVICE			
Isolation Surge Voltage (1) (Peak ac Voltage, 60 Hz, 1 sec Duration)	V _{ISO}	7500	Vac
Total Device Power Dissipation @ T _A = 25°C Derate above 25°C	P _D	250	mW
		2.94	mW/°C
Ambient Operating Temperature Range (2)	T _A	-55 to +100	°C
Storage Temperature Range	T _{stg}	-55 to +150	°C
Soldering Temperature (10 sec, 1/16" from case)	T _L	260	°C

(1) Isolation surge voltage is an internal device dielectric breakdown rating. For this test, Pins 1 and 2 are common, and Pins 4, 5 and 6 are common.

(2) Refer to Quality and Reliability Section for test information.

MOC8020
 [CTR = 500% Min]
MOC8021
 [CTR = 1000% Min]
 STYLE 3 PLASTIC



**STANDARD THRU HOLE
 CASE 730A-04**



**"T" LEADFORM
 WIDE SPACED 0.4"
 CASE 730D-05**



**"S"/"F" LEADFORM
 SURFACE MOUNT
 CASE 730C-04
 (STANDARD PROFILE)**



**CASE 730F-04
 (LOW PROFILE)**

SCHEMATIC

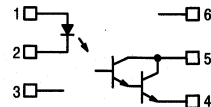

- PIN 1. LED ANODE
- 2. LED CATHODE
- 3. N.C.
- 4. EMITTER
- 5. COLLECTOR
- 6. N.C.

MOC8020, MOC8021

ELECTRICAL CHARACTERISTICS (T_A = 25°C unless otherwise noted)

Characteristic	Symbol	Min	Typ	Max	Unit
----------------	--------	-----	-----	-----	------

INPUT LED

Reverse Leakage Current (V _R = 3 V)	I _R	—	0.05	10	μA
Forward Voltage (I _F = 10 mA)	V _F	—	1.15	2	Volts
Capacitance (V _R = 0 V, f = 1 MHz)	C	—	18	—	pF

PHOTODARLINGTON (T_A = 25°C and I_F = 0, unless otherwise noted)

Collector-Emitter Dark Current (V _{CE} = 10 V)	I _{CEO}	—	—	100	nA
Collector-Emitter Breakdown Voltage (I _C = 1 mA)	V _{(BR)CEO}	50	—	—	Volts
Emitter-Collector Breakdown Voltage (I _E = 100 μA)	V _{(BR)ECO}	5	—	—	Volts

COUPLED (T_A = 25°C unless otherwise noted)

Collector Output Current (V _{CE} = 5 V, I _F = 10 mA)	I _C	50 100	— —	— —	mA
Isolation Surge Voltage (1, 2), 60 Hz Peak ac, 1 Second	V _{ISO}	7500	—	—	Volts
Isolation Resistance (1) (V = 500 V)	R _{ISO}	—	10 ¹¹	—	Ohms
Isolation Capacitance (1) (V = 0, f = 1 MHz)	C _{ISO}	—	0.2	—	pF

SWITCHING

Turn-On Time	V _{CC} = 10 V, R _L = 100 Ω, I _F = 5 mA	t _{on}	—	3.5	—	μs
Turn-Off Time		t _{off}	—	95	—	
Rise Time		t _r	—	1	—	
Fall Time		t _f	—	2	—	

- (1) For this test LED Pins 1 and 2 are common and Phototransistor Pins 4 and 5 are common.
 (2) Isolation Surge Voltage, V_{ISO}, is an internal device dielectric breakdown rating.

TYPICAL CHARACTERISTICS

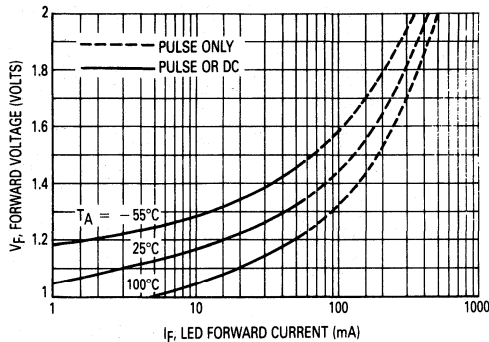

Figure 1. LED Forward Voltage versus Forward Current

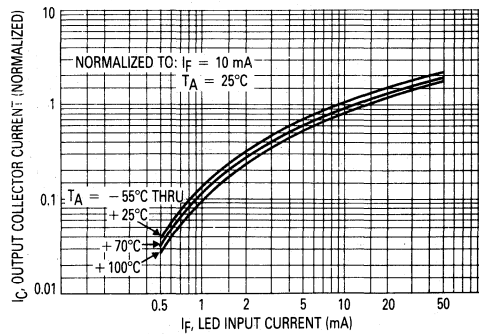

Figure 2. Output Current versus Input Current

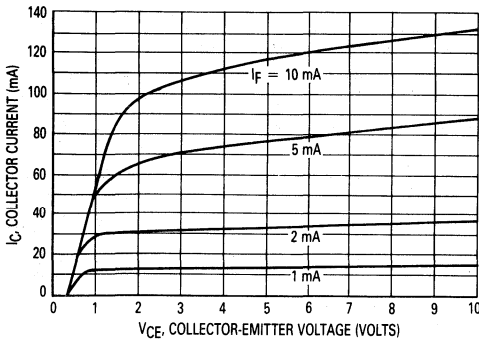

Figure 3. Collector Current versus Collector-Emitter Voltage

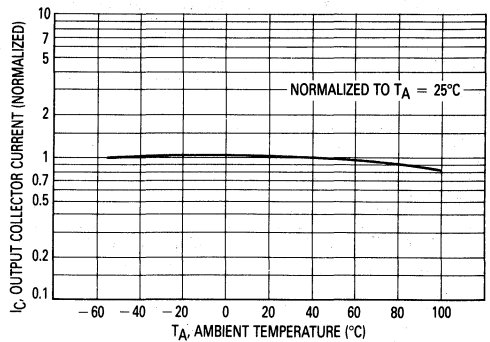

Figure 4. Output Current versus Ambient Temperature

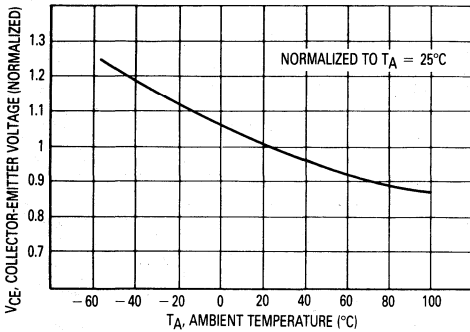

Figure 5. Collector-Emitter Voltage versus Ambient Temperature

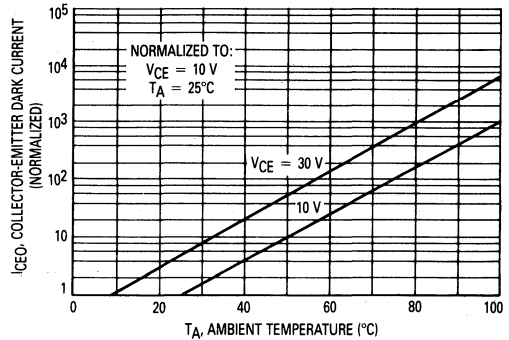

Figure 6. Collector-Emitter Dark Current versus Ambient Temperature

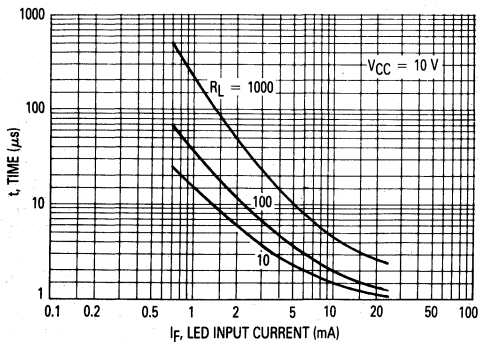

Figure 7. Turn-On Switching Times

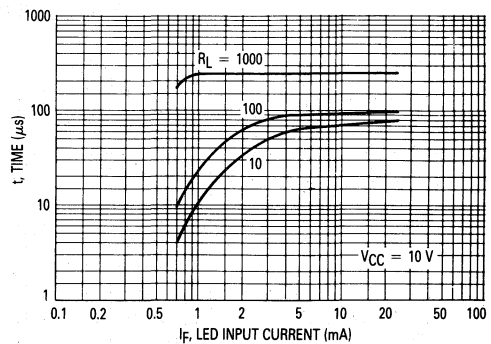

Figure 8. Turn-Off Switching Times

MOC8020, MOC8021

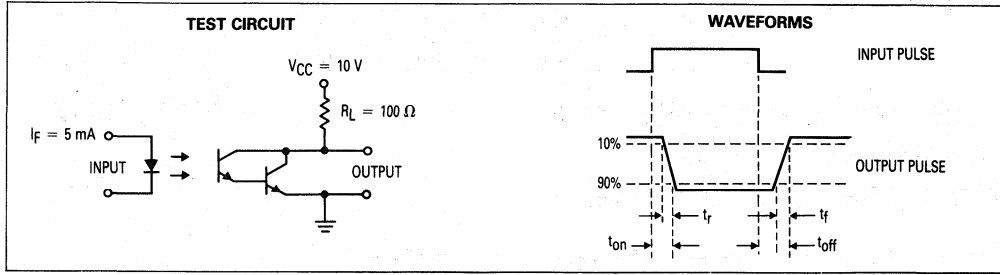

Figure 9. Switching Times



6-Pin DIP Optoisolators Darlington Output (No Base Connection)

The MOC8030 and MOC8050 devices consist of gallium arsenide infrared emitting diodes optically coupled to monolithic silicon photodarlington detectors. They are designed for use in applications requiring high sensitivity at low input currents.

- High Sensitivity to Low Input Drive Current
- High Collector-Emitter Breakdown Voltage — 80 Volts Minimum
- No Base Connection for Improved Noise Immunity

Applications

- Appliances, Measuring Instruments
- I/O Interfaces for Computers
- Programmable Controllers
- Portable Electronics
- Interfacing and coupling systems of different potentials and impedances
- Solid State Relays

MAXIMUM RATINGS ($T_A = 25^\circ\text{C}$ unless otherwise noted)

Rating	Symbol	Value	Unit
--------	--------	-------	------

INPUT LED

Reverse Voltage	V_R	3	Volts
Forward Current — Continuous	I_F	60	mA
LED Power Dissipation @ $T_A = 25^\circ\text{C}$ with Negligible Power in Output Detector Derate above 25°C	P_D	120	mW
		1.41	mW/ $^\circ\text{C}$

OUTPUT DETECTOR

Collector-Emitter Voltage	V_{CEO}	80	Volts
Emitter-Collector Voltage	V_{ECO}	5	Volts
Detector Power Dissipation @ $T_A = 25^\circ\text{C}$ with Negligible Power in Input LED Derate above 25°C	P_D	150	mW
		1.76	mW/ $^\circ\text{C}$

TOTAL DEVICE

Isolation Surge Voltage (1) (Peak ac Voltage, 60 Hz, 1 sec Duration)	V_{ISO}	7500	Vac
Total Device Power Dissipation @ $T_A = 25^\circ\text{C}$ Derate above 25°C	P_D	250	mW
		2.94	mW/ $^\circ\text{C}$
Ambient Operating Temperature Range (2)	T_A	-55 to +100	$^\circ\text{C}$
Storage Temperature Range	T_{stg}	-55 to +150	$^\circ\text{C}$
Soldering Temperature (10 sec, 1/16" from case)	T_L	260	$^\circ\text{C}$

(1) Isolation surge voltage is an internal device dielectric breakdown rating. For this test, Pins 1 and 2 are common, and Pins 4, 5 and 6 are common.

(2) Refer to Quality and Reliability Section for test information.

MOC8030
 [CTR = 300% Min]
MOC8050
 [CTR = 500% Min]
 Motorola Preferred Devices
 STYLE 3 PLASTIC



**STANDARD THRU HOLE
 CASE 730A-04**



**"T" LEADFORM
 WIDE SPACED 0.4"
 CASE 730D-05**



**"S"/"F" LEADFORM
 SURFACE MOUNT
 CASE 730C-04
 (STANDARD PROFILE)**



**CASE 730F-04
 (LOW PROFILE)**

SCHEMATIC

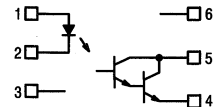

- PIN 1. LED ANODE
- LED CATHODE
- N.C.
- EMITTER
- COLLECTOR
- N.C.

MOC8030, MOC8050

ELECTRICAL CHARACTERISTICS ($T_A = 25^\circ\text{C}$ unless otherwise noted)

Characteristic	Symbol	Min	Typ	Max	Unit
INPUT LED					
Reverse Leakage Current ($V_R = 3\text{ V}$)	I_R	—	0.05	10	μA
Forward Voltage ($I_F = 10\text{ mA}$)	V_F	—	1.15	2	Volts
Capacitance ($V_R = 0\text{ V}$, $f = 1\text{ MHz}$)	C	—	18	—	pF

PHOTODARLINGTON ($T_A = 25^\circ\text{C}$ and $I_F = 0$, unless otherwise noted)

Collector-Emitter Dark Current ($V_{CE} = 60\text{ V}$)	I_{CEO}	—	—	1	μA
Collector-Emitter Breakdown Voltage ($I_C = 1\text{ mA}$)	$V_{(BR)CEO}$	80	—	—	Volts
Emitter-Collector Breakdown Voltage ($I_E = 100\ \mu\text{A}$)	$V_{(BR)ECO}$	5	—	—	Volts

COUPLED ($T_A = 25^\circ\text{C}$ unless otherwise noted)

Collector Output Current ($V_{CE} = 1.5\text{ V}$, $I_F = 10\text{ mA}$)	I_C	MOC8030 MOC8050	30 50	— —	— —	mA
Isolation Surge Voltage (1, 2), 60 Hz Peak ac, 5 Second	V_{ISO}	—	7500	—	—	Volts
Isolation Resistance (1) ($V = 500\text{ V}$)	R_{ISO}	—	10^{11}	—	—	Ohms
Isolation Capacitance (1) ($V = 0\text{ V}$, $f = 1\text{ MHz}$)	C_{ISO}	—	0.2	—	—	pF

SWITCHING

Turn-On Time	$V_{CC} = 10\text{ V}$, $R_L = 100\ \Omega$, $I_F = 5\text{ mA}$	t_{on}	—	3.5	—	μs
Turn-Off Time		t_{off}	—	95	—	
Rise Time		t_r	—	1	—	
Fall Time		t_f	—	2	—	

(1) For this test LED Pins 1 and 2 are common and Phototransistor Pins 4 and 5 are common.
 (2) Isolation Surge Voltage, V_{ISO} , is an internal device dielectric breakdown rating.

TYPICAL CHARACTERISTICS

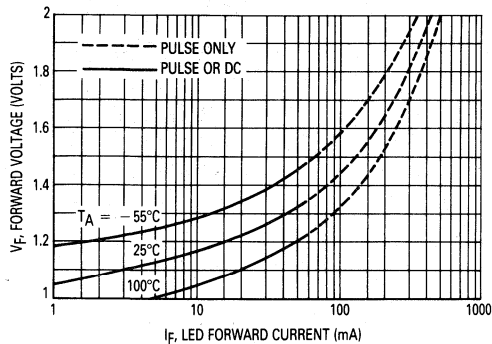

Figure 1. LED Forward Voltage versus Forward Current

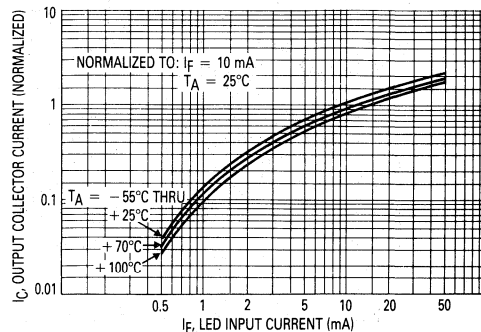

Figure 2. Output Current versus Input Current

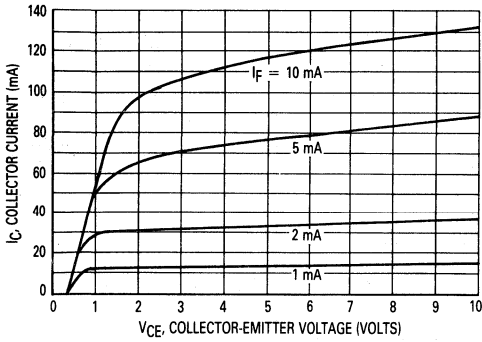

Figure 3. Collector Current versus Collector-Emitter Voltage

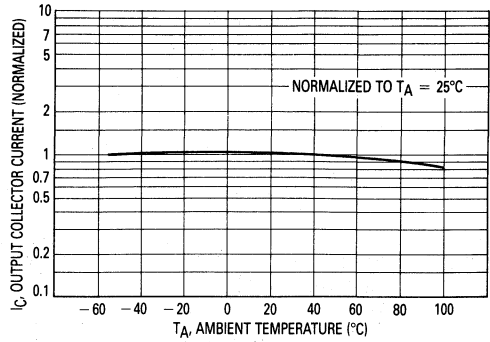

Figure 4. Output Current versus Ambient Temperature

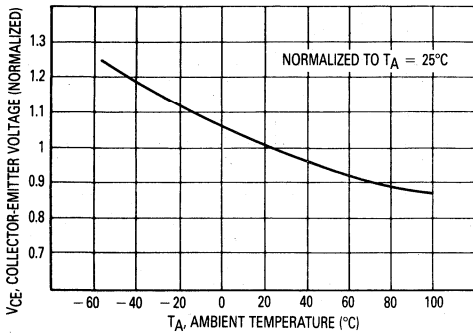

Figure 5. Collector-Emitter Voltage versus Ambient Temperature

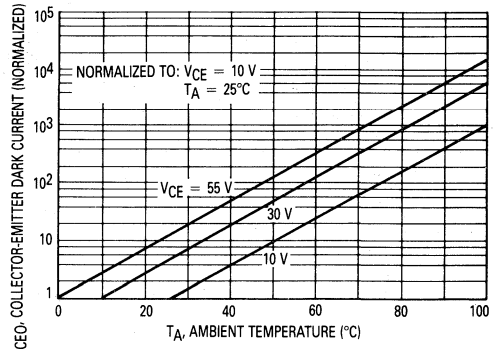

Figure 6. Collector-Emitter Dark Current versus Ambient Temperature

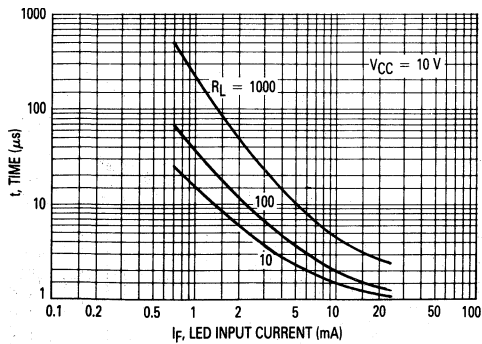

Figure 7. Turn-On Switching Times

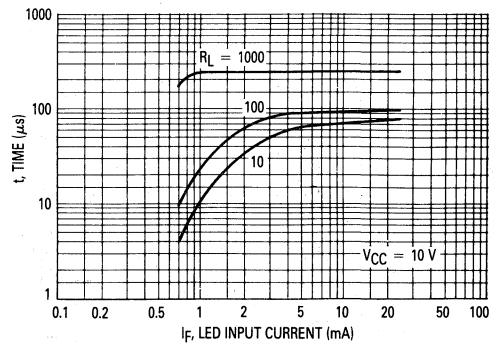

Figure 8. Turn-Off Switching Times

4

MOC8030, MOC8050

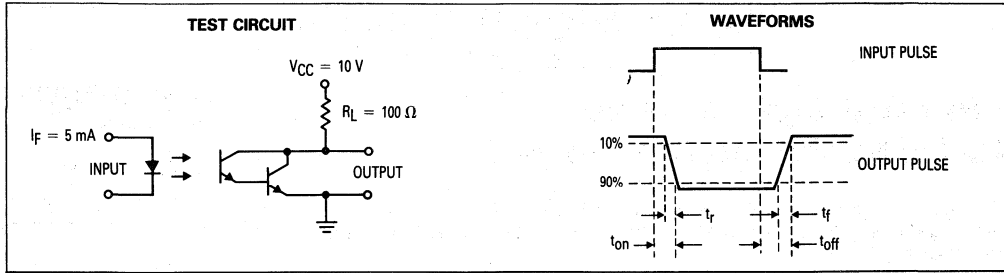

Figure 9. Switching Times



6-Pin DIP Optoisolator AC Input/Darlington Output

This device consists of two gallium arsenide infrared emitting diodes connected in inverse-parallel, optically coupled to a silicon photodarlington detector which has integral base-emitter resistor.

Applications

- Detection or Monitoring of ac Signals
- Interfacing and coupling systems of different potentials and impedances
- Phase Feedback Controls
- Solid State Relays
- General Purpose Switching Circuits

MAXIMUM RATINGS ($T_A = 25^\circ\text{C}$ unless otherwise noted)

Rating	Symbol	Value	Unit
--------	--------	-------	------

INPUT LED

Forward Current — Continuous	I_F	60	mA
Forward Current — Peak (PW = 100 μs , 120 pps)	$I_{F(pk)}$	1	A
LED Power Dissipation @ $T_A = 25^\circ\text{C}$ Derate above 25°C	P_D	120 1.41	mW mW/ $^\circ\text{C}$

OUTPUT TRANSISTOR

Collector-Emitter Voltage	V_{CEO}	50	Volts
Emitter-Base Voltage	V_{ECO}	7	Volts
Collector Current — Continuous	I_C	150	mA
Detector Power Dissipation @ $T_A = 25^\circ\text{C}$ Derate above 25°C	P_D	150 1.76	mW mW/ $^\circ\text{C}$

TOTAL DEVICE

Input-Output Isolation Voltage (1) (60 Hz, 1 sec. Duration)	V_{ISO}	3750	Vac
Total Device Power Dissipation @ $T_A = 25^\circ\text{C}$ Derate above 25°C	P_D	150 2.94	mW mW/ $^\circ\text{C}$
Ambient Operating Temperature Range (2)	T_A	-55 to +100	$^\circ\text{C}$
Storage Temperature Range	T_{stg}	-55 to +150	$^\circ\text{C}$
Lead Soldering Temperature (1/16" from case, 10 sec. duration)	T_L	260	$^\circ\text{C}$

(1) Input-Output Isolation Voltage, V_{ISO} , is an internal device dielectric breakdown rating. For this test, Pins 1 and 2 are common, and Pins 4, 5 and 6 are common.

(2) Refer to Quality and Reliability Section for test information.

MOC8060

[CTR = 1000% Min]

STYLE 8 PLASTIC



**STANDARD THRU HOLE
CASE 730A-04**



**"T" LEADFORM
WIDE SPACED 0.4"
CASE 730D-05**



**"S"/"F" LEADFORM
SURFACE MOUNT
CASE 730C-04
(STANDARD PROFILE)**



**CASE 730F-04
(LOW PROFILE)**

SCHEMATIC

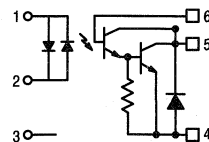

- PIN 1. INPUT LED
2. INPUT LED
3. N.C.
4. EMITTER
5. COLLECTOR
6. BASE**

ELECTRICAL CHARACTERISTICS ($T_A = 25^\circ\text{C}$ unless otherwise noted)

Characteristic	Symbol	Min	Typ	Max	Unit
INPUT LEAD					
Forward Voltage ($I_F = 10\text{ mA}$)	V_F	1.0	1.15	1.5	V
Capacitance ($V = 0, f = 1.0\text{ MHz}$)	C	—	18	—	pF
DARLINGTON OUTPUT					
Collector-Emitter Dark Current ($V_{CE} = 10\text{ V}, T_A = 25^\circ\text{C}$) ($V_{CE} = 10\text{ V}, T_A = 100^\circ\text{C}$)	I_{CEO1}	—	—	0.001	mA
	I_{CEO2}	—	0.1	—	mA
Collector-Emitter Breakdown Voltage ($I_C = 1.0\text{ mA}$)	$V_{(BR)CEO}$	50	65	—	V
Collector-Base Breakdown Voltage ($I_E = 100\text{ }\mu\text{A}$)	$V_{(BR)CBO}$	55	75	—	V
Collector-Emitter Capacitance ($f = 1.0\text{ MHz}, V_{CE} = 0$)	C_{CE}	—	7.0	—	pF
COUPLED					
Output Collector Current ($I_F = 10\text{ mA}, V_{CE} = 10\text{ V}$) ($I_F = 1.0\text{ mA}, V_{CE} = 10\text{ V}$)	I_C	100 5.0	— —	— —	mA
Output Current Symmetry (Note 1) (I_C at $I_F = +10\text{ mA}, V_{CE} = 10\text{ V}$) (I_C at $I_F = -10\text{ mA}, V_{CE} = 10\text{ V}$)		0.33	—	3.0	—
Collector-Emitter Saturation Voltage ($I_C = 100\text{ mA}, I_F = 10\text{ mA}$)	$V_{CE(sat)}$	—	—	2.0	V
Isolation Voltage ($f = 60\text{ Hz}, t = 1\text{ sec.}$)	V_{ISO}	3750	—	—	Vac(rms)
Isolation Resistance ($V_{I-O} = 500\text{ V}$)	R_{ISO}	10^{11}	—	—	Ω
Isolation Capacitance ($V_{I-O} = 0, f = 1.0\text{ MHz}$)	C_{ISO}	—	0.2	—	pF

Note 1: This specification guarantees that the higher of the two I_C readings will be no more than 3 times the lower at $I_F = 10\text{ mA}$.

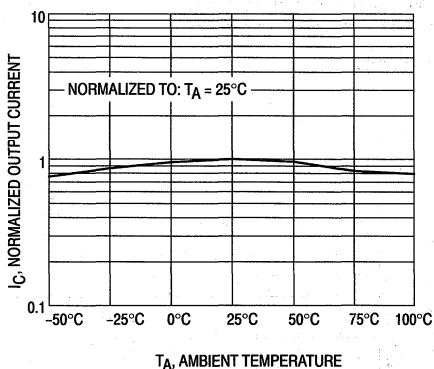

Figure 1. Output Current versus Ambient Temperature

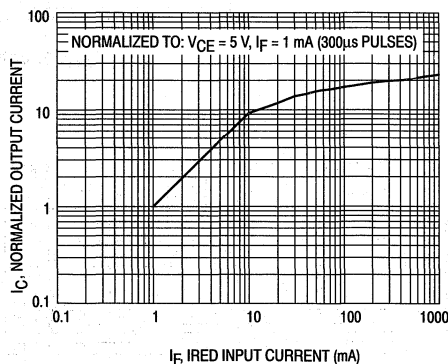

Figure 2. Output Current versus Input Current

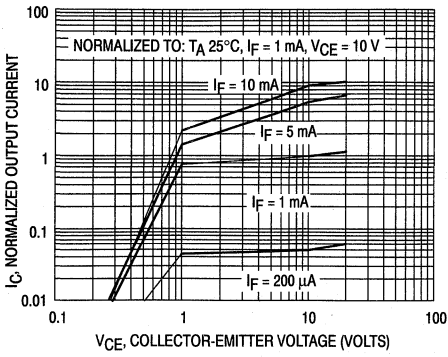

Figure 3. Output Current versus Collector-Emitter Voltage

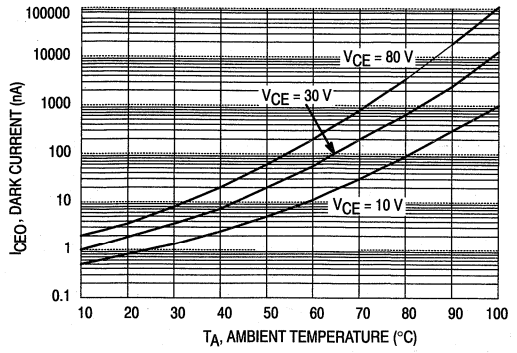

Figure 4. Collector-Emitter Dark Current versus Temperature

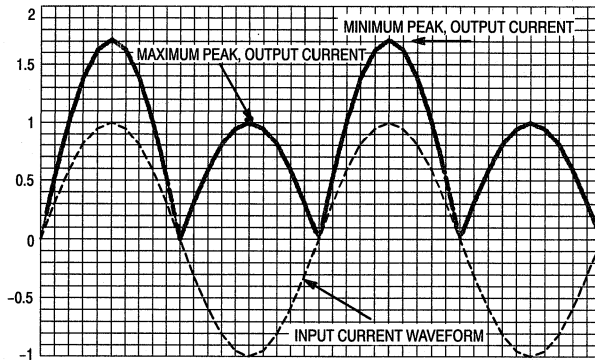

Figure 5. Output Characteristics

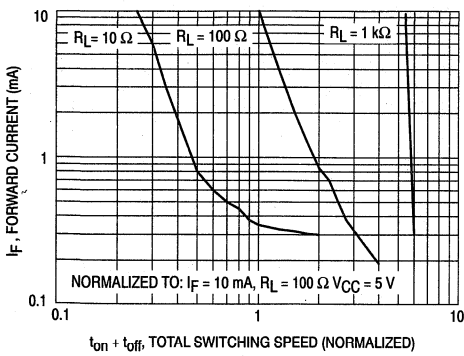

Figure 6. Input Current versus Total Switching Speed

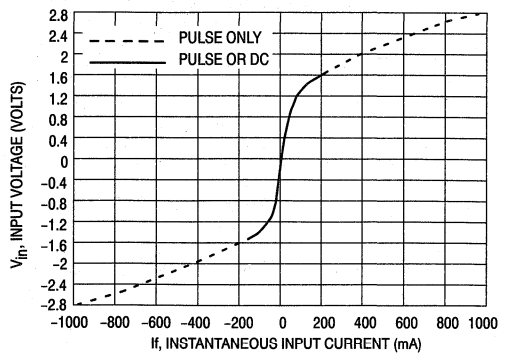

Figure 7. Input Voltage versus Input Current

MOC8060

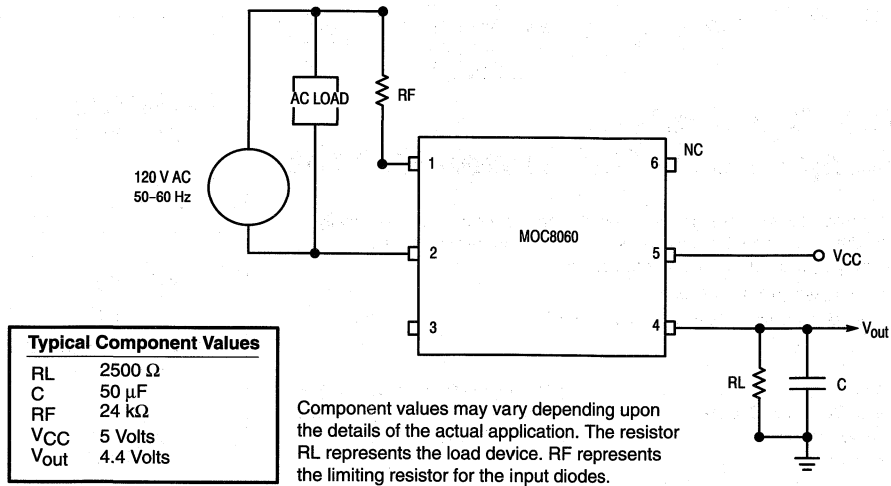

Figure 8. Typical Application Circuit: AC to DC Detector Circuit



6-Pin DIP Optoisolator High Temperature Darlington Output

The MOC8080 device consists of a gallium arsenide infrared emitting diode optically coupled to a monolithic silicon photodarlington detector. They are designed for use in applications requiring high sensitivity at low input currents.

- High Sensitivity to Low Input Drive Current
- Low, Stable Leakage Current at Elevated Temperature

Applications

- Appliances, Measuring Instruments
- General Purpose Switching Circuits
- Programmable Controllers
- Portable Electronics
- Interfacing and coupling systems of different potentials and impedances
- Solid State Relays

MAXIMUM RATINGS (T_A = 25°C unless otherwise noted)

Rating	Symbol	Value	Unit
--------	--------	-------	------

INPUT LED

Reverse Voltage	V _R	6	Volts
Forward Current — Continuous	I _F	60	mA
LED Power Dissipation @ T _A = 25°C with Negligible Power in Output Detector Derate above 25°C	P _D	120	mW
		1.41	mW/°C

OUTPUT DETECTOR

Collector-Emitter Voltage	V _{CEO}	55	Volts
Emitter-Collector Voltage	V _{ECO}	5	Volts
Collector-Base Voltage	V _{CBO}	55	Volts
Collector Current — Continuous	I _C	150	mA
Detector Power Dissipation @ T _A = 25°C with Negligible Power in Input LED Derate above 25°C	P _D	150	mW
		1.76	mW/°C

TOTAL DEVICE

Isolation Surge Voltage (1) (Peak ac Voltage, 60 Hz, 1 sec Duration)	V _{ISO}	7500	Vac
Total Device Power Dissipation @ T _A = 25°C Derate above 25°C	P _D	250 2.94	mW mW/°C
Ambient Operating Temperature Range (2)	T _A	-55 to +100	°C
Storage Temperature Range	T _{stg}	-55 to +150	°C
Soldering Temperature (10 sec, 1/16" from case)	T _L	260	°C

(1) Isolation surge voltage is an internal device dielectric breakdown rating. For this test, Pins 1 and 2 are common, and Pins 4, 5 and 6 are common.

(2) Refer to Quality and Reliability Section for test information.

MOC8080

(CTR = 500% Min)

STYLE 1 PLASTIC



STANDARD THRU HOLE
 CASE 730A-04



"T" LEADFORM
 WIDE SPACED 0.4"
 CASE 730D-05



"S"/"F" LEADFORM
 SURFACE MOUNT
 CASE 730C-04
 (STANDARD PROFILE)



CASE 730F-04
 (LOW PROFILE)

SCHEMATIC

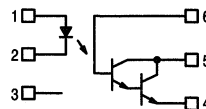

- PIN 1. LED ANODE
- 2. LED CATHODE
- 3. N.C.
- 4. EMITTER
- 5. COLLECTOR
- 6. BASE

MOC8080

ELECTRICAL CHARACTERISTICS (T_A = 25°C unless otherwise noted)

Characteristic	Symbol	Min	Typ	Max	Unit
INPUT LED					
Forward Voltage (I _F = 10 mA)	T _A = 25°C	0.8	1.15	1.5	V
	T _A = -55°C	0.9	1.3	1.7	
	T _A = 100°C	0.7	1.05	1.4	
Reverse Leakage Current (V _R = 3 V)	I _R	—	—	100	μA
Capacitance (V = 0 V, f = 1 MHz)	C	—	18	—	pF

OUTPUT DETECTOR

Collector-Emitter Dark Current (V _{CE} = 10 V)	T _A = 25°C	I _{CEO}	—	5	100	nA
	T _A = 100°C		—	5	100	μA
Collector-Base Dark Current (V _{CB} = 10 V)	T _A = 25°C	I _{CBO}	—	1	20	nA
	T _A = 100°C		—	100	—	
Collector-Emitter Breakdown Voltage (I _C = 1 mA)	V _{(BR)CEO}	55	80	—	V	
Collector-Base Breakdown Voltage (I _C = 100 μA)	V _{(BR)CBO}	55	100	—	V	
Emitter-Collector Breakdown Voltage (I _E = 100 μA)	V _{(BR)ECO}	5	7	—	V	
DC Current Gain (I _C = 5 mA, V _{CE} = 5 V)	h _{FE}	—	16 k	—	—	
Collector-Emitter Capacitance (f = 1 MHz, V _{CE} = 5 V)	C _{CE}	—	3.9	—	pF	
Collector-Base Capacitance (f = 1 MHz, V _{CB} = 5 V)	C _{CB}	—	6.3	—	pF	
Emitter-Base Capacitance (f = 1 MHz, V _{EB} = 5 V)	C _{EB}	—	3.8	—	pF	

COUPLED

Output Collector Current (I _F = 10 mA, V _{CE} = 5 V)	I _C	50	117	—	mA
Collector-Emitter Saturation Voltage (I _C = 1 mA, I _F = 1 mA)	V _{CE(sat)}	—	0.6	1	V
Turn-On Time	t _{on}	—	3.5	—	μs
Turn-Off Time	t _{off}	—	95	—	
Rise Time	t _r	—	1	—	
Fall Time	t _f	—	2	—	
V _{CC} = 10 V, R _L = 100 Ω, I _F = 5 mA					
Isolation Voltage (f = 60 Hz, t = 1 sec) (1)	V _{ISO}	7500	—	—	Vac(pk)
Isolation Resistance (V = 500 V) (1)	R _{ISO}	10 ¹¹	—	—	Ω
Isolation Capacitance (V = 0 V, f = 1 MHz) (1)	C _{ISO}	—	0.2	2	pF

Note: (1) For this test, Pins 1 and 2 are common, and Pins 4, 5 and 6 are common.

TYPICAL CHARACTERISTICS

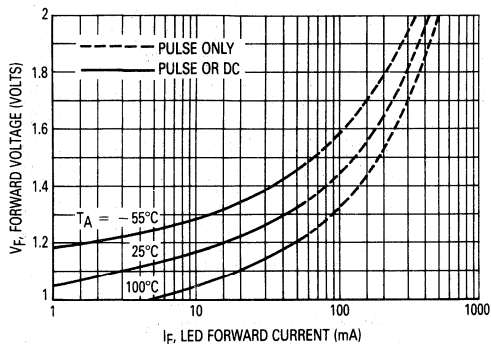

Figure 1. LED Forward Voltage versus Forward Current

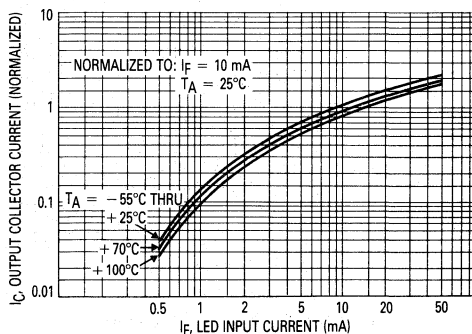

Figure 2. Output Current versus Input Current

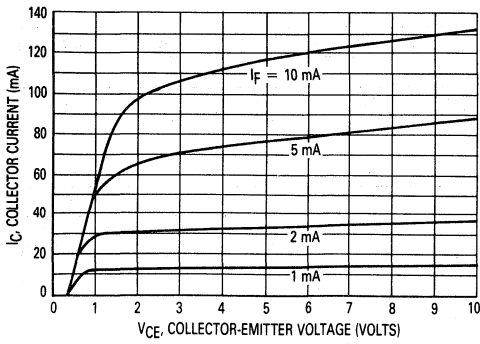

Figure 3. Collector Current versus Collector-Emitter Voltage

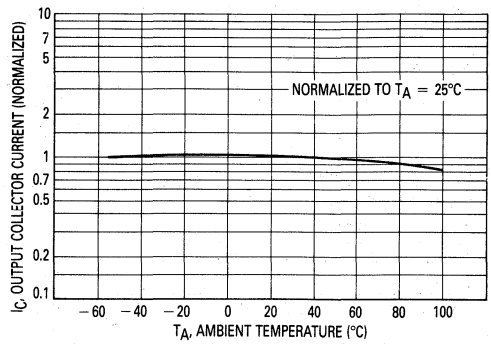

Figure 4. Output Current versus Ambient Temperature

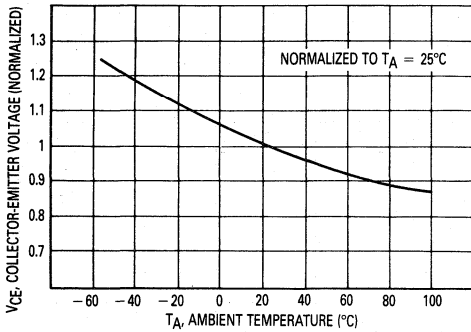

Figure 5. Collector-Emitter Voltage versus Ambient Temperature

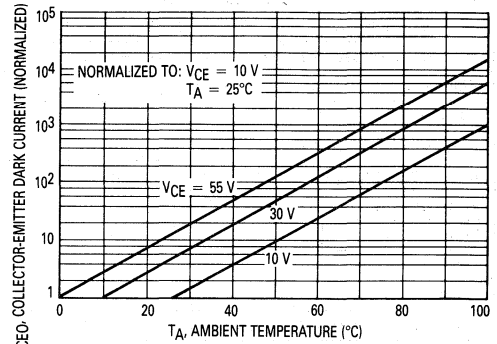

Figure 6. Collector-Emitter Dark Current versus Ambient Temperature

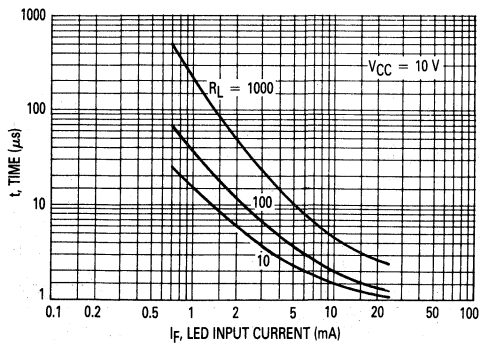

Figure 7. Turn-On Switching Times

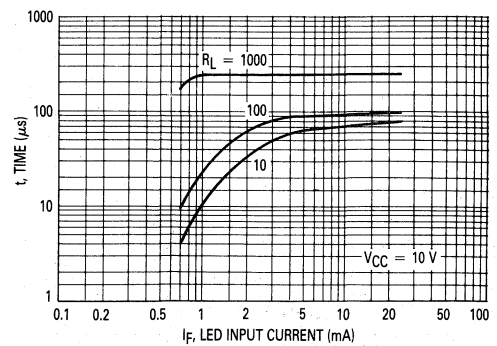

Figure 8. Turn-Off Switching Times

4

MOC8080

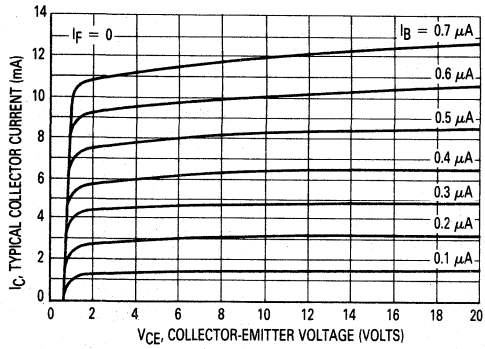

Figure 9. DC Current Gain (Detector Only)

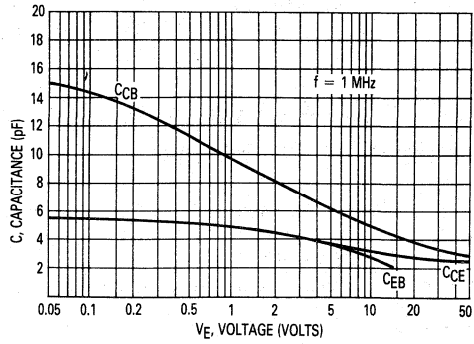

Figure 10. Detector Capacitances versus Voltage

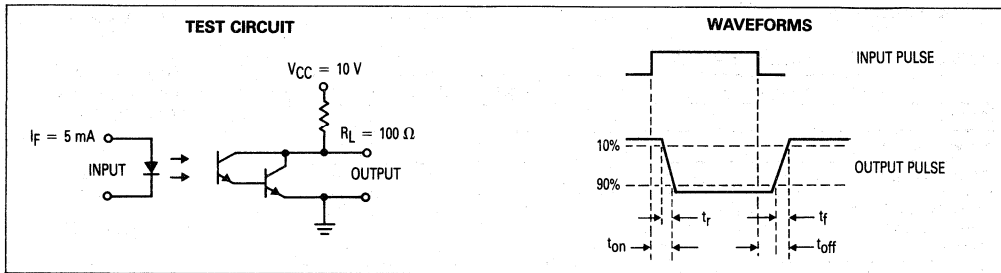
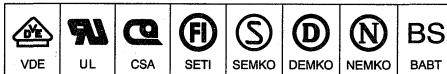

Figure 11. Switching Times

MOTOROLA SEMICONDUCTOR TECHNICAL DATA



6-Pin DIP Optoisolator Transistor Output

The MOC8100 device consists of a gallium arsenide infrared emitting diode optically coupled to a monolithic silicon phototransistor detector. It is designed for applications requiring low LED drive current.

- High Current Transfer Ratio Guaranteed at 1 mA LED Drive Level

Applications

- Appliances, Measuring Instruments
- General Purpose Switching Circuits
- Programmable Controllers
- Portable Electronics
- Interfacing and coupling systems of different potentials and impedances
- Low Power Logic Circuits
- Telecommunications Equipment

MAXIMUM RATINGS (T_A = 25°C unless otherwise noted)

Rating	Symbol	Value	Unit
--------	--------	-------	------

INPUT LED

Reverse Voltage	V _R	6	Volts
Forward Current — Continuous	I _F	60	mA
LED Power Dissipation @ T _A = 25°C with Negligible Power in Output Detector Derate above 25°C	P _D	120	mW
		1.41	mW/°C

OUTPUT TRANSISTOR

Collector-Emitter Voltage	V _{CEO}	30	Volts
Emitter-Base Voltage	V _{EBO}	7	Volts
Collector-Base Voltage	V _{CBO}	70	Volts
Collector Current — Continuous	I _C	150	mA
Detector Power Dissipation @ T _A = 25°C with Negligible Power in Input LED Derate above 25°C	P _D	150	mW
		1.76	mW/°C

TOTAL DEVICE

Isolation Surge Voltage (1) (Peak ac Voltage, 60 Hz, 1 sec Duration)	V _{ISO}	7500	Vac
Total Device Power Dissipation @ T _A = 25°C Derate above 25°C	P _D	250 2.94	mW mW/°C
Ambient Operating Temperature Range (2)	T _A	-55 to +100	°C
Storage Temperature Range	T _{stg}	-55 to +150	°C
Soldering Temperature (10 sec, 1/16" from case)	T _L	260	°C

(1) Isolation surge voltage is an internal device dielectric breakdown rating. For this test, Pins 1 and 2 are common, and Pins 4, 5 and 6 are common.

(2) Refer to Quality and Reliability Section for test information.

MOC8100

[CTR = 50% Min]

STYLE 1 PLASTIC



STANDARD THRU HOLE
CASE 730A-04



"T" LEADFORM
WIDE SPACED 0.4"
CASE 730D-05



"S"/"F" LEADFORM
SURFACE MOUNT
CASE 730C-04
(STANDARD PROFILE)



CASE 730F-04
(LOW PROFILE)

SCHEMATIC

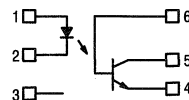

- PIN 1. LED ANODE
- 2. LED CATHODE
- 3. N.C.
- 4. EMITTER
- 5. COLLECTOR
- 6. BASE

MOC8100

ELECTRICAL CHARACTERISTICS ($T_A = 25^\circ\text{C}$ unless otherwise noted)

Characteristic	Symbol	Min	Typ	Max	Unit
INPUT LED					
Forward Voltage ($I_F = 10\text{ mA}$)	V_F	—	$T_A = 0-70^\circ\text{C}$	1.15	Volts
			$T_A = -55^\circ\text{C}$	1.3	
			$T_A = 100^\circ\text{C}$	1.05	
Reverse Leakage Current ($V_R = 6\text{ V}$)	I_R	—	0.05	10	μA
Capacitance ($V = 0\text{ V}$, $f = 1\text{ MHz}$)	C_J	—	18	—	pF

OUTPUT TRANSISTOR

Collector-Emitter Dark Current	I_{CEO}	—	$(V_{CE} = 5\text{ V}, T_A = 25^\circ\text{C})$	3	25	nA
			$(V_{CE} = 30\text{ V}, T_A = 70^\circ\text{C})$	0.05	50	μA
Collector-Base Dark Current ($V_{CB} = 5\text{ V}$)	I_{CBO}	—	0.2	10	nA	
Collector-Emitter Breakdown Voltage ($I_C = 1\text{ mA}$)	$V_{(BR)CEO}$	30	45	—	Volts	
Collector-Base Breakdown Voltage ($I_C = 100\text{ }\mu\text{A}$)	$V_{(BR)CBO}$	70	100	—	Volts	
Emitter-Base Breakdown Voltage ($I_E = 100\text{ }\mu\text{A}$)	$V_{(BR)EBO}$	7	7.8	—	Volts	
DC Current Gain ($I_C = 1\text{ mA}$, $V_{CE} = 5\text{ V}$)	h_{FE}	—	600	—	—	
Collector-Emitter Capacitance ($f = 1\text{ MHz}$, $V_{CE} = 0$)	C_{CE}	—	7	—	pF	
Collector-Base Capacitance ($f = 1\text{ MHz}$, $V_{CB} = 0$)	C_{CB}	—	19	—	pF	
Emitter-Base Capacitance ($f = 1\text{ MHz}$, $V_{EB} = 0$)	C_{EB}	—	9	—	pF	

COUPLED

Output Collector Current ($I_F = 1\text{ mA}$, $V_{CE} = 5\text{ V}$) ($I_F = 1\text{ mA}$, $V_{CE} = 5\text{ V}$, $T_A = 0\text{ to }+70^\circ\text{C}$)	I_C	0.5	1	—	mA
		0.3	0.6	—	
Collector-Emitter Saturation Voltage ($I_C = 100\text{ }\mu\text{A}$, $I_F = 1\text{ mA}$)	$V_{CE(sat)}$	—	0.22	0.5	Volts
Turn-On Time ($I_C = 2\text{ mA}$, $V_{CC} = 10\text{ V}$, $R_L = 100\text{ }\Omega$, Figure 11)	t_{on}	—	9	20	μs
Turn-Off Time ($I_C = 2\text{ mA}$, $V_{CC} = 10\text{ V}$, $R_L = 100\text{ }\Omega$, Figure 11)	t_{off}	—	7	20	μs
Rise Time ($I_C = 2\text{ mA}$, $V_{CC} = 10\text{ V}$, $R_L = 100\text{ }\Omega$, Figure 11)	t_r	—	3.8	—	μs
Fall Time ($I_C = 2\text{ mA}$, $V_{CC} = 10\text{ V}$, $R_L = 100\text{ }\Omega$, Figure 11)	t_f	—	5.6	—	μs
Isolation Voltage ($f = 60\text{ Hz}$, $t = 1\text{ sec}$)	V_{ISO}	—	—	—	$V_{ac(pk)}$
Isolation Resistance ($V = 500\text{ V}$)	R_{ISO}	10^{11}	—	—	Ω
Isolation Capacitance ($V = 0\text{ V}$, $f = 1\text{ MHz}$)	C_{ISO}	—	0.2	2	pF

TYPICAL CHARACTERISTICS

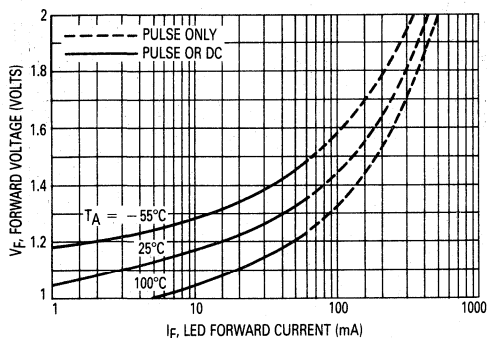

Figure 1. LED Forward Voltage versus Forward Current

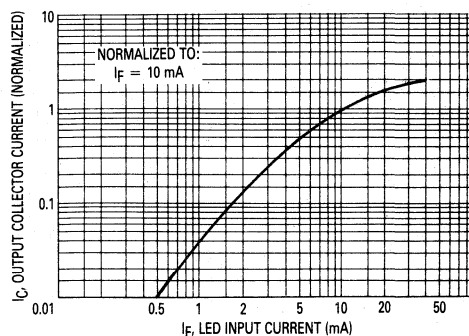

Figure 2. Output Current versus Input Current



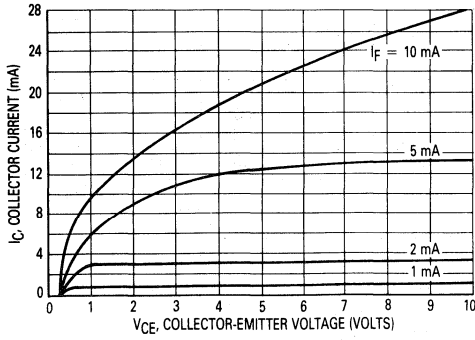

Figure 3. Collector Current versus Collector-Emitter Voltage

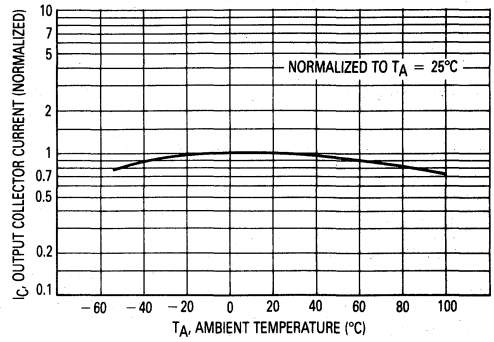

Figure 4. Output Current versus Ambient Temperature

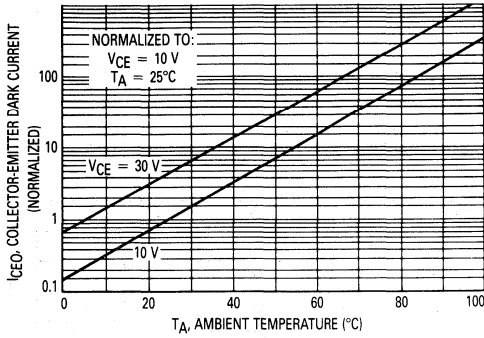

Figure 5. Dark Current versus Ambient Temperature

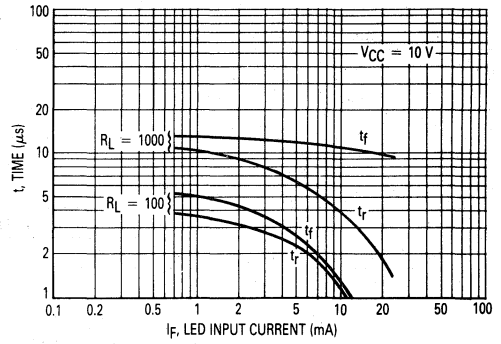

Figure 6. Rise and Fall Times

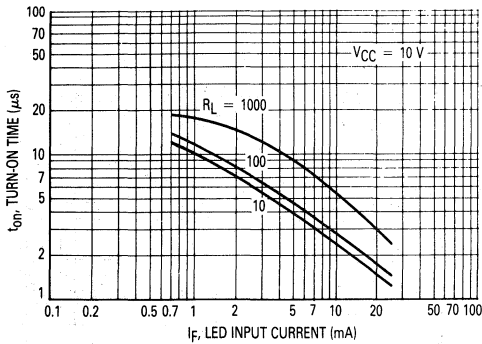

Figure 7. Turn-On Switching Times

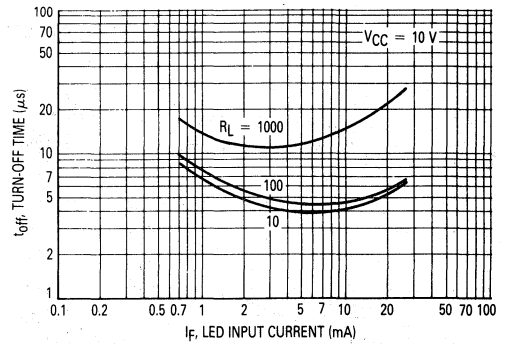

Figure 8. Turn-Off Switching Times

4

MOC8100

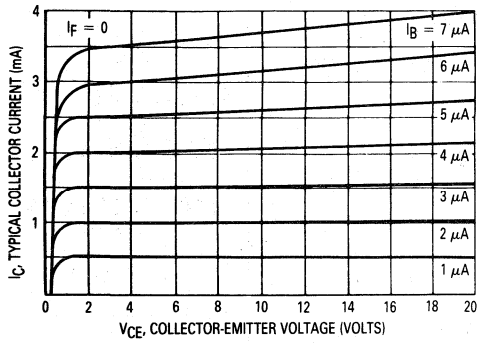

Figure 9. DC Current Gain (Detector Only)

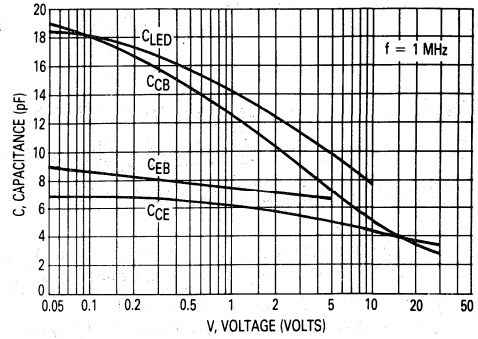

Figure 10. Capacitances versus Voltage

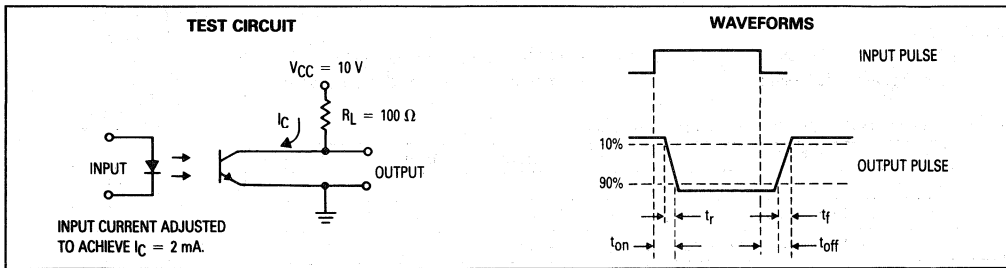

Figure 11. Switching Times



6-Pin DIP Optoisolators For Power Supply Applications (No Base Connection)

The MOC8101, MOC8102, MOC8103 and MOC8104 devices consist of a gallium arsenide LED optically coupled to a silicon phototransistor in a dual-in-line package.

- Closely Matched Current Transfer Ratio (CTR)
- Narrow (CTR) Windows that translate to a Narrow and Predictable Open Loop Gain Window
- Very Low Coupled Capacitance along with No Base Connection for Minimum Noise Susceptibility

Applications

- Switchmode Power Supplies (Feedback Control)
- AC Line/Digital Logic Isolation
- Interfacing and coupling systems of different potentials and impedances

MAXIMUM RATINGS ($T_A = 25^\circ\text{C}$ unless otherwise noted)

Rating	Symbol	Value	Unit
INPUT LED			
Forward Current — Continuous	I_F	60	mA
Forward Current — Peak (PW = 100 μs , 120 pps)	$I_F(\text{pk})$	1	A
Reverse Voltage	V_R	6	Volts
LED Power Dissipation @ $T_A = 25^\circ\text{C}$ Derate above 25°C	P_D	120 1.41	mW mW/ $^\circ\text{C}$

OUTPUT TRANSISTOR

Collector-Emitter Voltage	V_{CEO}	30	Volts
Emitter-Collector Voltage	V_{ECO}	7	Volts
Collector Current — Continuous	I_C	150	mA
Detector Power Dissipation @ $T_A = 25^\circ\text{C}$ Derate above 25°C	P_D	150 1.76	mW mW/ $^\circ\text{C}$

TOTAL DEVICE

Input-Output Isolation Voltage (1) (f = 60 Hz, t = 1 sec.)	V_{ISO}	3750 7500	$V_{ac}(\text{rms})$ $V_{ac}(\text{pk})$
Total Device Power Dissipation @ $T_A = 25^\circ\text{C}$ Derate above 25°C	P_D	250 2.94	mW mW/ $^\circ\text{C}$
Ambient Operating Temperature Range (2)	T_A	-55 to +100	$^\circ\text{C}$
Storage Temperature Range	T_{stg}	-55 to +150	$^\circ\text{C}$
Lead Soldering Temperature (1/16" from case, 10 sec. duration)	T_L	260	$^\circ\text{C}$

(1) Input-Output Isolation Voltage, V_{ISO} , is an internal device dielectric breakdown rating. For this test, Pins 1 and 2 are common, and Pins 4, 5 and 6 are common.

(2) Refer to Quality and Reliability Section for test information.

MOC8101*
[CTR = 50–80%]
MOC8102*
[CTR = 73–117%]
MOC8103
[CTR = 108–173%]
MOC8104
[CTR = 160–256%]
*Motorola Preferred Devices
STYLE 3 PLASTIC



STANDARD THRU HOLE
CASE 730A-04



"T" LEADFORM
WIDE SPACED 0.4"
CASE 730D-05



"S"/"F" LEADFORM
SURFACE MOUNT
CASE 730C-04
(STANDARD PROFILE)



CASE 730F-04
(LOW PROFILE)

SCHEMATIC

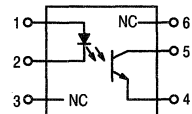

- PIN 1. ANODE
2. CATHODE
3. NO CONNECTION
4. EMITTER
5. COLLECTOR
6. NO CONNECTION

MOC8101, MOC8102, MOC8103, MOC8104

ELECTRICAL CHARACTERISTICS ($T_A = 25^\circ\text{C}$ unless otherwise noted)

Characteristic	Symbol	Min	Typ	Max	Unit
----------------	--------	-----	-----	-----	------

INPUT LED

Forward Voltage ($I_F = 10\text{ mA}$)	V_F	1.0	1.15	1.5	V
Reverse Leakage Current ($V_R = 5.0\text{ V}$)	I_R	—	0.05	10	μA
Capacitance	C	—	18	—	pF

OUTPUT TRANSISTOR

Collector-Emitter Dark Current	$(V_{CE} = 10\text{ V}, T_A = 25^\circ\text{C})$	I_{CE01}	—	1.0	50	nA
	$(V_{CE} = 10\text{ V}, T_A = 100^\circ\text{C})$	I_{CE02}	—	1.0	—	μA
Collector-Emitter Breakdown Voltage ($I_C = 1.0\text{ mA}$)	$V_{(BR)CEO}$	30	45	—	V	
Emitter-Collector Breakdown Voltage ($I_E = 100\text{ }\mu\text{A}$)	$V_{(BR)ECO}$	7.0	7.8	—	V	
Collector-Emitter Capacitance ($f = 1.0\text{ MHz}, V_{CE} = 0$)	C_{CE}	—	7.0	—	pF	

COUPLED

Output Collector Current ($I_F = 10\text{ mA}, V_{CE} = 10\text{ V}$)	MOC8101	I_C	5.0	6.5	8.0	mA
	MOC8102		7.3	9.0	11.7	
	MOC8103		10.8	14	17.3	
	MOC8104		16	20	25.6	
Collector-Emitter Saturation Voltage ($I_C = 500\text{ }\mu\text{A}, I_F = 5.0\text{ mA}$)	$V_{CE(sat)}$	—	0.15	0.4	V	
Turn-On Time ($I_C = 2.0\text{ mA}, V_{CC} = 10\text{ V}, R_L = 100\text{ }\Omega$)	t_{on}	—	7.5	20	μs	
Turn-Off Time ($I_C = 2.0\text{ mA}, V_{CC} = 10\text{ V}, R_L = 100\text{ }\Omega$)	t_{off}	—	5.7	20	μs	
Rise Time ($I_C = 2.0\text{ mA}, V_{CC} = 10\text{ V}, R_L = 100\text{ }\Omega$)	t_r	—	3.2	—	μs	
Fall Time ($I_C = 2.0\text{ mA}, V_{CC} = 10\text{ V}, R_L = 100\text{ }\Omega$)	t_f	—	4.7	—	μs	
Isolation Voltage ($f = 60\text{ Hz}, t = 1.0\text{ sec.}$)	V_{ISO}	3750	—	—	Vac(rms)	
Isolation Resistance ($V_{I-O} = 500\text{ V}$)	R_{ISO}	10^{11}	—	—	Ω	
Isolation Capacitance ($V_{I-O} = 0, f = 1.0\text{ MHz}$)	C_{ISO}	—	0.2	—	pF	

4

TYPICAL CHARACTERISTICS

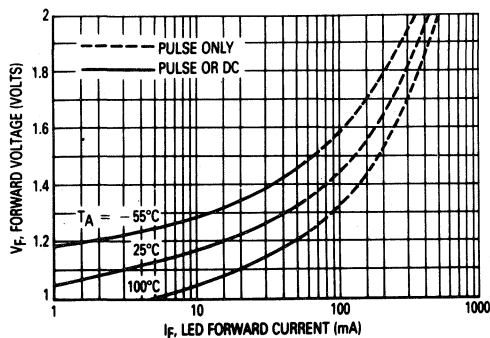

Figure 1. LED Forward Voltage versus Forward Current

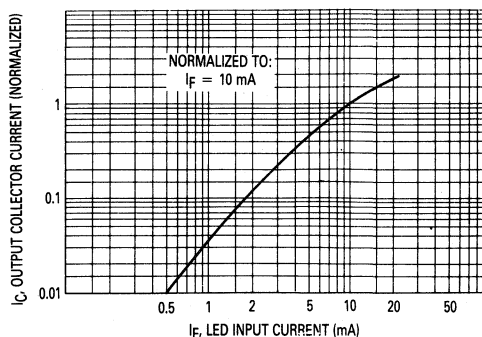

Figure 2. Output Current versus Input Current

MOC8101, MOC8102, MOC8103, MOC8104

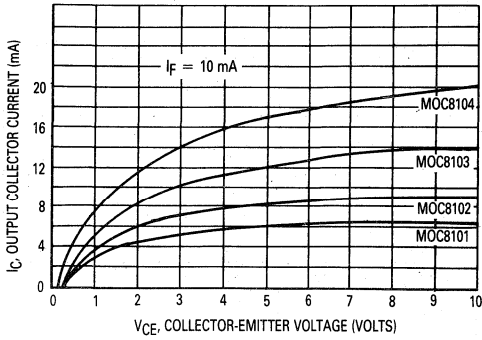

Figure 3. Output Current versus Collector-Emitter Voltage

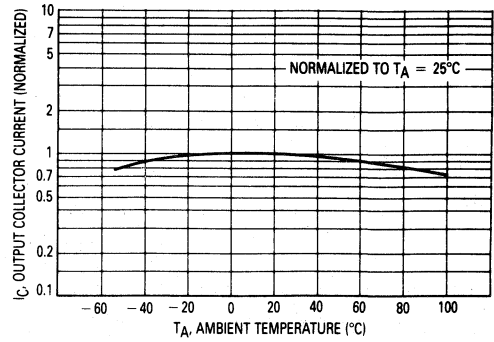

Figure 4. Output Current versus Ambient Temperature

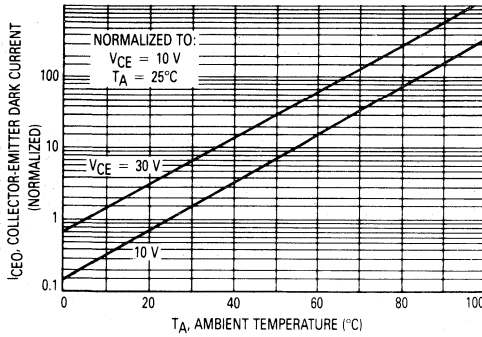

Figure 5. Dark Current versus Ambient Temperature

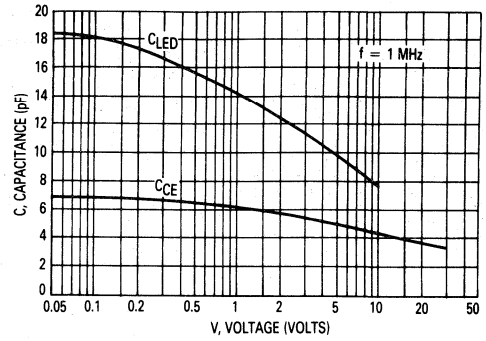
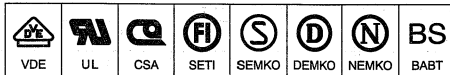

Figure 6. Capacitance versus Voltage

4

MOTOROLA SEMICONDUCTOR TECHNICAL DATA



6-Pin DIP Optoisolators Transistor Output (No Base Connection)

The MOC8111, MOC8112 and MOC8113 devices consist of a gallium arsenide infrared emitting diode optically coupled to a monolithic silicon phototransistor detector. The internal base-to-Pin 6 connection has been eliminated for improved noise immunity.

Applications

- Appliances, Measuring Instruments
- Regulation and Feedback Control
- Programmable Controllers
- Interfacing and coupling systems of different potentials and impedances
- General Purpose Switching Circuits

MAXIMUM RATINGS ($T_A = 25^\circ\text{C}$ unless otherwise noted)

Rating	Symbol	Value	Unit
INPUT LED			
Reverse Voltage	V_R	6	Volts
Forward Current — Continuous	I_F	60	mA
LED Power Dissipation @ $T_A = 25^\circ\text{C}$ with Negligible Power in Output Detector Derate above 25°C	P_D	120	mW
		1.41	$\text{mW}/^\circ\text{C}$

OUTPUT TRANSISTOR

Collector-Emitter Voltage	V_{CEO}	30	Volts
Emitter-Collector Voltage	V_{ECO}	7	Volts
Collector Current — Continuous	I_C	150	mA
Detector Power Dissipation @ $T_A = 25^\circ\text{C}$ with Negligible Power in Input LED Derate above 25°C	P_D	150	mW
		1.76	$\text{mW}/^\circ\text{C}$

TOTAL DEVICE

Isolation Surge Voltage (1) (Peak ac Voltage, 60 Hz, 1 sec Duration)	V_{ISO}	7500	Vac
Total Device Power Dissipation @ $T_A = 25^\circ\text{C}$ Derate above 25°C	P_D	250 2.94	mW $\text{mW}/^\circ\text{C}$
Ambient Operating Temperature Range (2)	T_A	-55 to +100	$^\circ\text{C}$
Storage Temperature Range	T_{stg}	-55 to +150	$^\circ\text{C}$
Soldering Temperature (10 sec, 1/16" from case)	T_L	260	$^\circ\text{C}$

(1) Isolation surge voltage is an internal device dielectric breakdown rating. For this test, Pins 1 and 2 are common, and Pins 4, 5 and 6 are common.

(2) Refer to Quality and Reliability Section for test information.

MOC8111*

[CTR = 20% Min]

MOC8112

[CTR = 50% Min]

MOC8113

[CTR = 100% Min]

*Motorola Preferred Device
STYLE 3 PLASTIC



STANDARD THRU HOLE
CASE 730A-04



"T" LEADFORM
WIDE SPACED 0.4"
CASE 730D-05



"S"/"F" LEADFORM
SURFACE MOUNT
CASE 730C-04
(STANDARD PROFILE)



CASE 730F-04
(LOW PROFILE)

SCHEMATIC

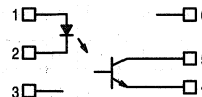

- PIN 1. LED ANODE
- 2. LED CATHODE
- 3. N.C.
- 4. EMITTER
- 5. COLLECTOR
- 6. N.C.

MOC8111, MOC8112, MOC8113

ELECTRICAL CHARACTERISTICS ($T_A = 25^\circ\text{C}$ unless otherwise noted)

Characteristic	Symbol	Min	Typ	Max	Unit
INPUT LED					
Forward Voltage ($I_F = 10\text{ mA}$)	V_F	—	1.15	1.5	Volts
		—	1.3	—	
		—	1.05	—	
Reverse Leakage Current ($V_R = 6\text{ V}$)	I_R	—	0.05	10	μA
Capacitance ($V = 0, f = 1\text{ MHz}$)	C_J	—	18	—	pF
OUTPUT TRANSISTOR					
Collector-Emitter Dark Current	I_{CEO}	—	1	50	nA
Collector-Emitter Breakdown Voltage ($I_C = 1\text{ mA}$)	$V_{(BR)CEO}$	30	45	—	Volts
Emitter-Collector Breakdown Voltage ($I_E = 100\ \mu\text{A}$)	$V_{(BR)ECO}$	7	7.8	—	Volts
Collector-Emitter Capacitance ($f = 1\text{ MHz}, V_{CE} = 0$)	C_{CE}	—	7	—	pF
COUPLED					
Output Collector Current ($I_F = 10\text{ mA}, V_{CE} = 10\text{ V}$)	I_C	2	5	—	mA
		5	10	—	
		10	20	—	
Collector-Emitter Saturation Voltage ($I_C = 500\ \mu\text{A}, I_F = 10\text{ mA}$)	$V_{CE(sat)}$	—	0.15	0.4	Volts
Turn-On Time ($I_C = 2\text{ mA}, V_{CC} = 10\text{ V}, R_L = 100\ \Omega$, Figure 10)	t_{on}	—	7.5	20	μs
Turn-Off Time ($I_C = 2\text{ mA}, V_{CC} = 10\text{ V}, R_L = 100\ \Omega$, Figure 10)	t_{off}	—	5.7	20	μs
Rise Time ($I_C = 2\text{ mA}, V_{CC} = 10\text{ V}, R_L = 100\ \Omega$, Figure 10)	t_r	—	3.2	—	μs
Fall Time ($I_C = 2\text{ mA}, V_{CC} = 10\text{ V}, R_L = 100\ \Omega$, Figure 10)	t_f	—	4.7	—	μs
Isolation Voltage ($f = 60\text{ Hz}, t = 1\text{ sec}$)	V_{ISO}	7500	—	—	Vac(pk)
Isolation Resistance ($V = 500\text{ V}$)	R_{ISO}	10^{11}	—	—	Ω
Isolation Capacitance ($V = 0, f = 1\text{ MHz}$)	C_{ISO}	—	0.2	—	pF

TYPICAL CHARACTERISTICS

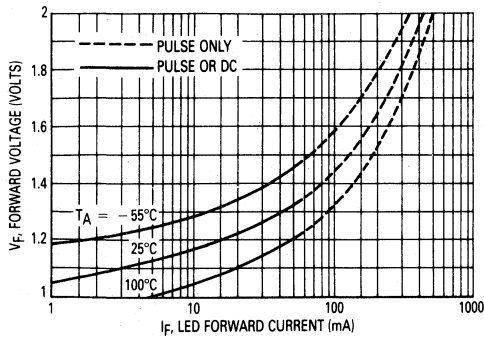

Figure 1. LED Forward Voltage versus Forward Current

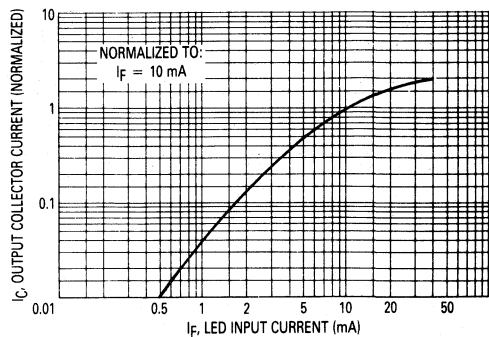

Figure 2. Output Current versus Input Current

MOC8111, MOC8112, MOC8113

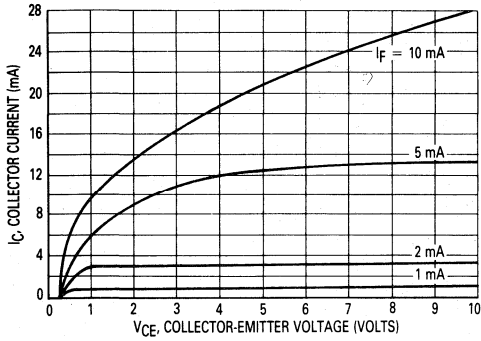

Figure 3. Collector Current versus Collector-Emitter Voltage

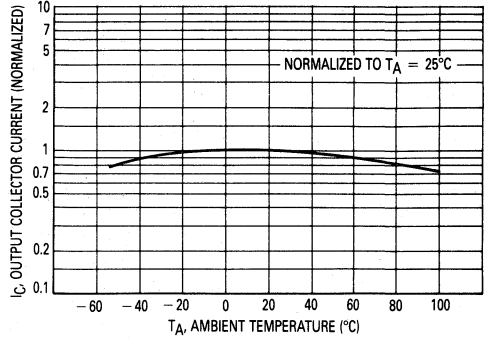

Figure 4. Output Current versus Ambient Temperature

4

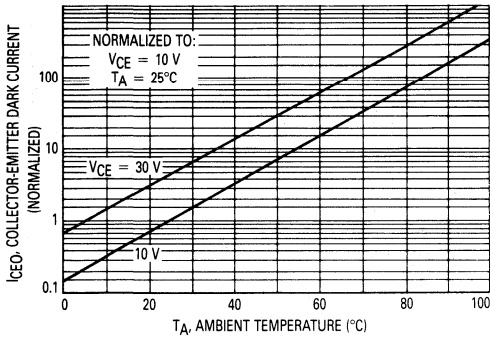

Figure 5. Dark Current versus Ambient Temperature

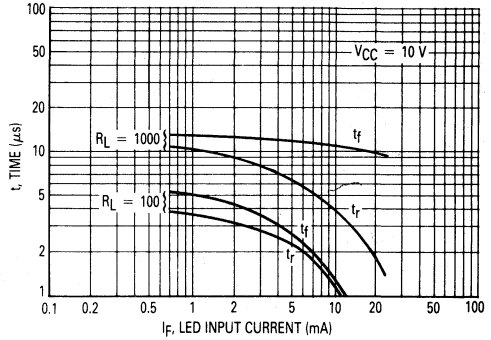

Figure 6. Rise and Fall Times

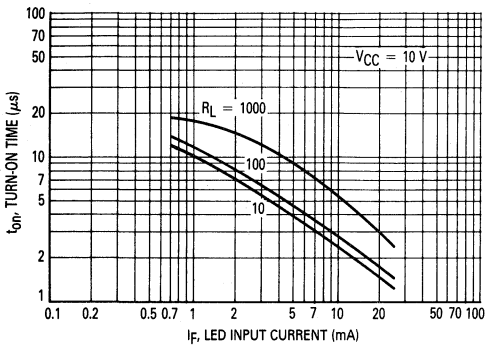

Figure 7. Turn-On Switching Times

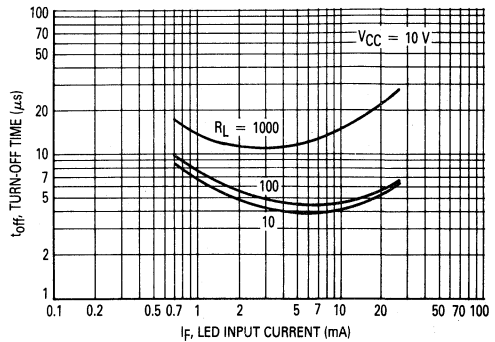

Figure 8. Turn-Off Switching Times

MOC8111, MOC8112, MOC8113

4

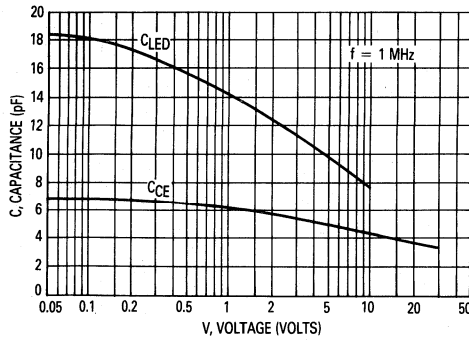

Figure 9. Capacitances versus Voltage

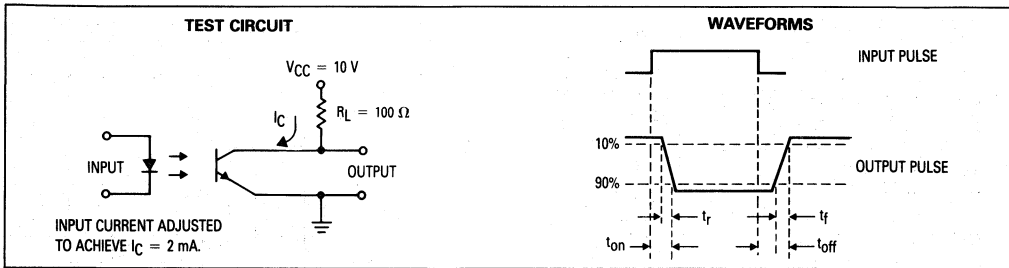

Figure 10. Switching Times

MOTOROLA SEMICONDUCTOR TECHNICAL DATA



6-Pin DIP Optoisolators High Voltage Transistor Output (400 Volts)

The MOC8204, MOC8205 and MOC8206 devices consist of gallium arsenide infrared emitting diodes optically coupled to high voltage, silicon, phototransistor detectors in a standard 6-pin DIP package. They are designed for applications requiring high voltage output and are particularly useful in copy machines and solid state relays.

Applications

- Copy Machines
- Interfacing and coupling systems of different potentials and impedances
- Monitor and Detection Circuits
- Solid State Relays

MAXIMUM RATINGS ($T_A = 25^\circ\text{C}$ unless otherwise noted)

Rating	Symbol	Value	Unit
INPUT LED			
Forward Current — Continuous	I_F	60	mA
Forward Current — Peak Pulse Width = 1 μs , 330 pps	I_F	1.2	Amp
LED Power Dissipation @ $T_A = 25^\circ\text{C}$ Derate above 25°C	P_D	120 1.41	mW mW/ $^\circ\text{C}$
OUTPUT TRANSISTOR			
Collector-Emitter Voltage	V_{CER}	400	Volts
Emitter-Collector Voltage	V_{ECO}	7	Volts
Collector-Base Voltage	V_{CBO}	400	mA
Collector Current (Continuous)	I_C	100	mA
Detector Power Dissipation @ $T_A = 25^\circ\text{C}$ Derate above 25°C	P_D	150 1.76	mW mW/ $^\circ\text{C}$

TOTAL DEVICE

Total Device Power Dissipation @ $T_A = 25^\circ\text{C}$ Derate above 25°C	P_D	250 2.94	mW mW/ $^\circ\text{C}$
Operating Temperature Range (2)	T_J	-55 to +100	$^\circ\text{C}$
Storage Temperature Range	T_{stg}	-55 to +150	$^\circ\text{C}$
Soldering Temperature (10 s)	T_L	260	$^\circ\text{C}$
Isolation Surge Voltage Peak ac Voltage, 60 Hz, 1 Second Duration (1)	V_{ISO}	7500	Vac(pk)

(1) Isolation surge voltage is an internal device dielectric breakdown rating. For this test, Pins 1 and 2 are common, and Pins 4, 5 and 6 are common.

(2) Refer to Quality and Reliability Section for test information.

MOC8204*

[CTR = 20% Min]

MOC8205

[CTR = 10% Min]

MOC8206

[CTR = 5% Min]

*Motorola Preferred Device
STYLE 1 PLASTIC



STANDARD THRU HOLE
CASE 730A-04



"T" LEADFORM
WIDE SPACED 0.4"
CASE 730D-05



"S"/"F" LEADFORM
SURFACE MOUNT
CASE 730C-04
(STANDARD PROFILE)



CASE 730F-04
(LOW PROFILE)

SCHEMATIC

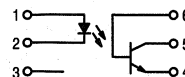

- PIN 1. ANODE
- CATHODE
- N.C.
- EMITTER
- COLLECTOR
- BASE

MOC8204, MOC8205, MOC8206

ELECTRICAL CHARACTERISTICS

Characteristic	Symbol	Min	Typ	Max	Unit
----------------	--------	-----	-----	-----	------

INPUT LED ($T_A = 25^\circ\text{C}$ unless otherwise noted)

Reverse Leakage Current ($V_R = 6\text{ V}$)	I_R	—	—	10	μA
Forward Voltage ($I_F = 10\text{ mA}$)	V_F	—	1.2	1.5	Volts
Capacitance ($V = 0\text{ V}, f = 1\text{ MHz}$)	C_J	—	18	—	pF

OUTPUT TRANSISTOR ($T_A = 25^\circ\text{C}$ and $I_F = 0$ unless otherwise noted)

Collector-Emitter Dark Current ($R_{BE} = 1\text{ M}\Omega$) ($V_{CE} = 300\text{ V}$)	I_{CER}	—	—	100	nA
		$T_A = 25^\circ\text{C}$	—	—	μA
		$T_A = 100^\circ\text{C}$	—	250	
Collector-Base Breakdown Voltage ($I_C = 100\text{ }\mu\text{A}$)	$V_{(BR)CBO}$	400	—	—	Volts
Collector-Emitter Breakdown Voltage ($I_C = 1\text{ mA}, R_{BE} = 1\text{ M}\Omega$)	$V_{(BR)CER}$	400	—	—	Volts
Emitter-Base Breakdown Voltage ($I_E = 100\text{ }\mu\text{A}$)	$V_{(BR)EBO}$	7	—	—	Volts

COUPLED ($T_A = 25^\circ\text{C}$ unless otherwise noted)

Current Transfer Ratio ($V_{CE} = 10\text{ V}, I_F = 10\text{ mA}, R_{BE} = 1\text{ M}\Omega$)	MOC8204 MOC8205 MOC8206	CTR	20 10 5	— — —	— — —	%
Surge Isolation Voltage (Input to Output) (1) Peak ac Voltage, 60 Hz, 1 sec		V_{ISO}	7500	—	—	Volts
Isolation Resistance (1) ($V = 500\text{ V}$)		R_{ISO}	—	10^{11}	—	Ohms
Collector-Emitter Saturation Voltage ($I_C = 0.5\text{ mA}, I_F = 10\text{ mA}, R_{BE} = 1\text{ M}\Omega$)		$V_{CE(sat)}$	—	—	0.4	Volts
Isolation Capacitance (1) ($V = 0\text{ V}, f = 1\text{ MHz}$)		C_{ISO}	—	0.2	—	pF
Turn-On Time	$V_{CC} = 10\text{ V}, I_C = 2\text{ mA}, R_L = 100\text{ }\Omega$	t_{on}	—	5	—	μs
Turn-Off Time		t_{off}	—	5	—	

NOTE: 1. For this test LED Pins 1 and 2 are common and phototransistor Pins 4, 5, and 6 are common.

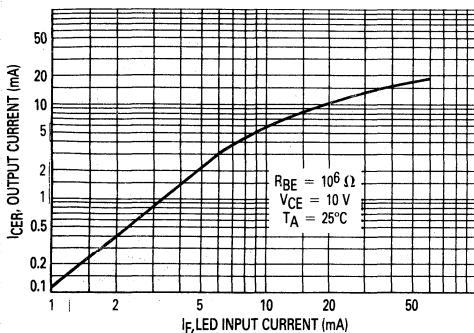

Figure 1. Output Current versus LED Input Current

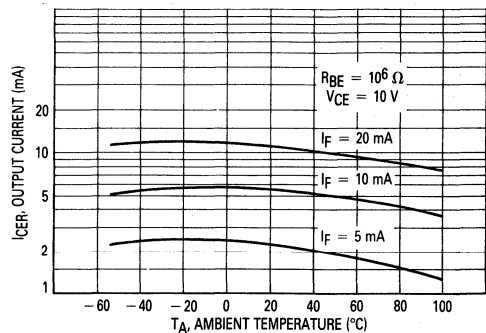

Figure 2. Output Current versus Temperature

MOC8204, MOC8205, MOC8206

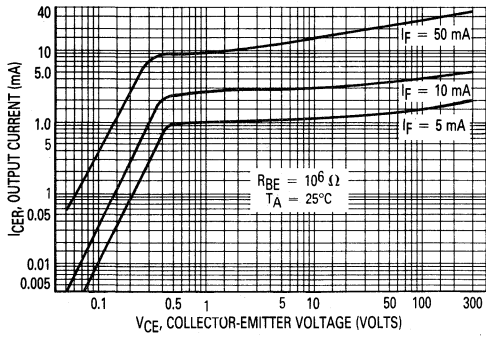

Figure 3. Output Characteristics

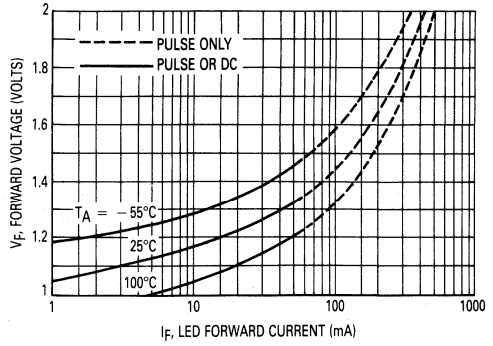

Figure 4. Forward Characteristics

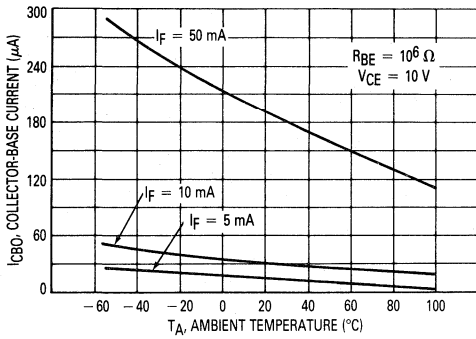

Figure 5. Collector-Base Current versus Temperature

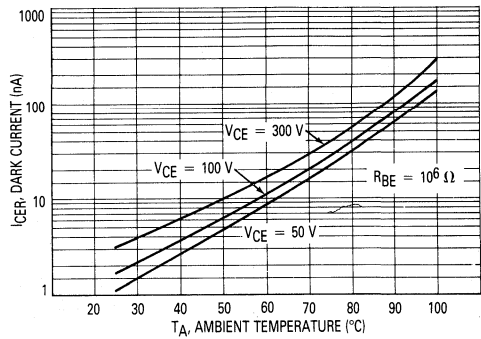
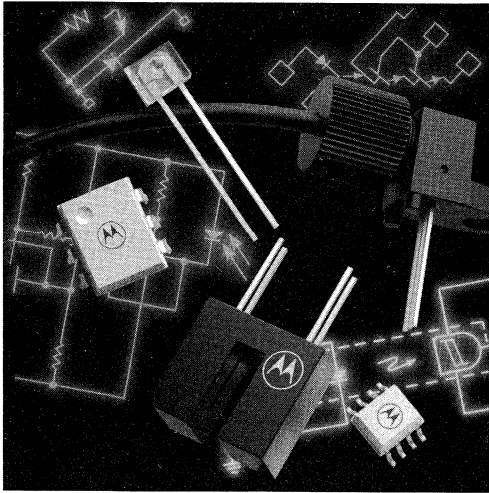

Figure 6. Dark Current versus Temperature



Section Five

SOIC-8 Small Outline Optoisolators

5

MOC205	5-2
MOC211	5-5
MOC215	5-8
MOC221	5-11

Small Outline Optoisolators Transistor Output

These devices consist of a gallium arsenide infrared emitting diode optically coupled to a monolithic silicon phototransistor detector, in a surface mountable, small outline, plastic package. They are ideally suited for high density applications, and eliminate the need for through-the-board mounting.

- Convenient Plastic SOIC-8 Surface Mountable Package Style
- Closely Matched Current Transfer Ratios
- Minimum $V_{(BR)CEO}$ of 70 Volts Guaranteed
- Standard SOIC-8 Footprint, with .050" Lead Spacing
- Shipped in Tape and Reel, which Conforms to EIA Standard RS481A
- Compatible with Dual Wave, Vapor Phase and IR Reflow Soldering
- High Input-Output Isolation of 2500 Vac (rms) Guaranteed
- UL Recognized  File #E54915

Ordering Information:

- To obtain MOC205, 206, 207 in Tape and Reel, add R1 or R2 suffix to device numbers as follows:
 R1-500 units on 7" reel
 R2-2500 units on 13" reel
- To obtain MOC205, 206, 207 in quantities of 75 (shipped in sleeves) — No Suffix

Marking Information:

- MOC205 = 205
- MOC206 = 206
- MOC207 = 207

Applications:

- Feedback Control Circuits
- Interfacing and coupling systems of different potentials and impedances
- General Purpose Switching Circuits
- Monitor and Detection Circuits

MAXIMUM RATINGS ($T_A = 25^\circ\text{C}$ unless otherwise noted)

Rating	Symbol	Value	Unit
--------	--------	-------	------

INPUT LED

Forward Current — Continuous	I_F	60	mA
Forward Current — Peak (PW = 100 μs , 120 pps)	$I_F(\text{pk})$	1.0	A
Reverse Voltage	V_R	6.0	V
LED Power Dissipation @ $T_A = 25^\circ\text{C}$ Derate above 25°C	P_D	90 0.8	mW mW/ $^\circ\text{C}$

OUTPUT TRANSISTOR

Collector-Emitter Voltage	V_{CEO}	70	V
Collector-Base Voltage	V_{CBO}	70	V
Emitter-Collector Voltage	V_{ECO}	7.0	V
Collector Current — Continuous	I_C	150	mA
Detector Power Dissipation @ $T_A = 25^\circ\text{C}$ Derate above 25°C	P_D	150 1.76	mW mW/ $^\circ\text{C}$

(continued)

MOC205

[CTR = 40-80%]

MOC206

[CTR = 63-125%]

MOC207

[CTR = 100-200%]

Motorola Preferred Devices
 STYLE 1 PLASTIC

SMALL OUTLINE OPTOISOLATORS TRANSISTOR OUTPUT

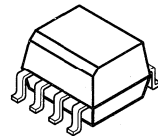

CASE 846-01

SCHEMATIC

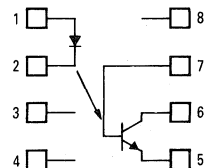

- 1: LED ANODE
- 2: LED CATHODE
- 3: NO CONNECTION
- 4: NO CONNECTION
- 5: EMITTER
- 6: COLLECTOR
- 7: BASE
- 8: NO CONNECTION

MOC205, MOC206, MOC207

MAXIMUM RATINGS — continued ($T_A = 25^\circ\text{C}$ unless otherwise noted)

Rating	Symbol	Value	Unit
Input-Output Isolation Voltage (1) (60 Hz, 1.0 sec. duration)	V_{ISO}	2500	Vac(rms)
Total Device Power Dissipation @ $T_A = 25^\circ\text{C}$ Derate above 25°C	P_D	150 2.94	mW mW/ $^\circ\text{C}$
Ambient Operating Temperature Range	T_A	-55 to +100	$^\circ\text{C}$
Storage Temperature Range	T_{stg}	-55 to +150	$^\circ\text{C}$
Lead Soldering Temperature (1/16" from case, 10 sec. duration)	—	260	$^\circ\text{C}$

ELECTRICAL CHARACTERISTICS ($T_A = 25^\circ\text{C}$ unless otherwise noted)

Characteristic	Symbol	Min	Typ	Max	Unit
----------------	--------	-----	-----	-----	------

INPUT LED

Forward Voltage ($I_F = 10\text{ mA}$)	V_F	—	1.15	1.5	V
Reverse Leakage Current ($V_R = 6.0\text{ V}$)	I_R	—	0.1	100	μA
Capacitance	C	—	18	—	pF

OUTPUT TRANSISTOR

Collector-Emitter Dark Current	$(V_{CE} = 10\text{ V}, T_A = 25^\circ\text{C})$	I_{CEO1}	—	1.0	50	nA
	$(V_{CE} = 10\text{ V}, T_A = 100^\circ\text{C})$	I_{CEO2}	—	1.0	—	μA
Collector-Emitter Breakdown Voltage ($I_C = 100\ \mu\text{A}$)	$V_{(BR)CEO}$	70	120	—	V	
Emitter-Collector Breakdown Voltage ($I_E = 100\ \mu\text{A}$)	$V_{(BR)ECO}$	7.0	7.8	—	V	
Collector-Emitter Capacitance ($f = 1.0\text{ MHz}, V_{CE} = 0$)	C_{CE}	—	7.0	—	pF	

COUPLED

Output Collector Current ($I_F = 10\text{ mA}, V_{CE} = 10\text{ V}$)	MOC205	I_C	4.0	6.0	8.0	mA
	MOC206		6.3	9.4	12.5	
	MOC207		10	15	20	
Collector-Emitter Saturation Voltage ($I_C = 2.0\text{ mA}, I_F = 10\text{ mA}$)		$V_{CE(sat)}$	—	0.15	0.4	V
Turn-On Time ($I_C = 2.0\text{ mA}, V_{CC} = 10\text{ V}, R_L = 100\ \Omega$)		t_{on}	—	3.0	—	μs
Turn-Off Time ($I_C = 2.0\text{ mA}, V_{CC} = 10\text{ V}, R_L = 100\ \Omega$)		t_{off}	—	2.8	—	μs
Rise Time ($I_C = 2.0\text{ mA}, V_{CC} = 10\text{ V}, R_L = 100\ \Omega$)		t_r	—	1.6	—	μs
Fall Time ($I_C = 2.0\text{ mA}, V_{CC} = 10\text{ V}, R_L = 100\ \Omega$)		t_f	—	2.2	—	μs
Isolation Voltage ($f = 60\text{ Hz}, t = 1.0\text{ sec.}$)		V_{ISO}	2500	—	—	Vac(rms)
Isolation Resistance ($V_{I-O} = 500\text{ V}$)		R_{ISO}	10^{11}	—	—	Ω
Isolation Capacitance ($V_{I-O} = 0, f = 1.0\text{ MHz}$)		C_{ISO}	—	0.2	—	pF

(1) Input-Output Isolation Voltage, V_{ISO} , is an internal device dielectric breakdown rating. For this test, pins 1 and 2 are common, and pins 5, 6 and 7 are common.

TYPICAL CHARACTERISTICS

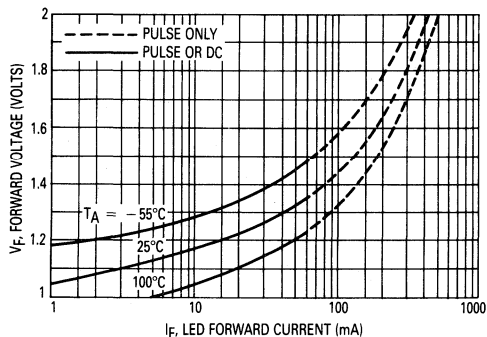

Figure 1. LED Forward Voltage versus Forward Current

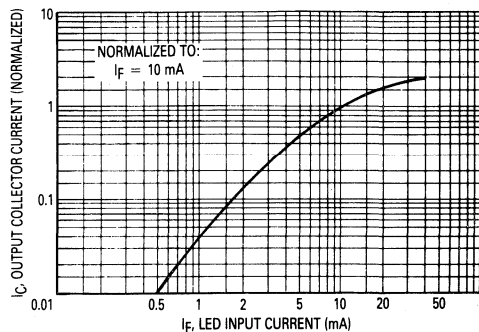

Figure 2. Output Current versus Input Current

MOC205, MOC206, MOC207

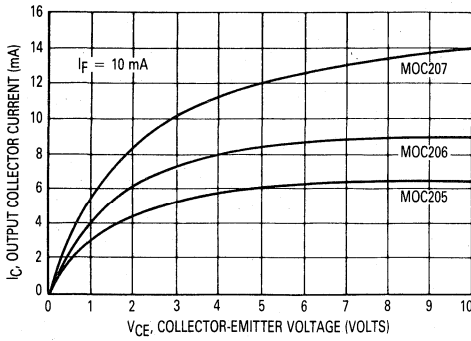

Figure 3. Output Current versus Collector-Emitter Voltage

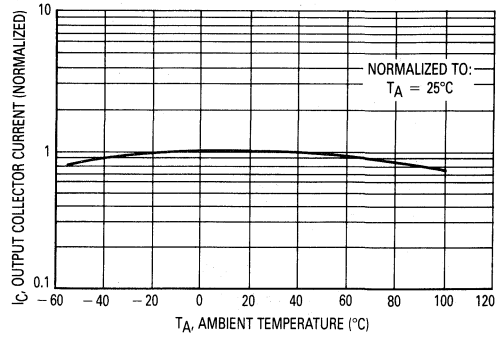

Figure 4. Output Current versus Ambient Temperature

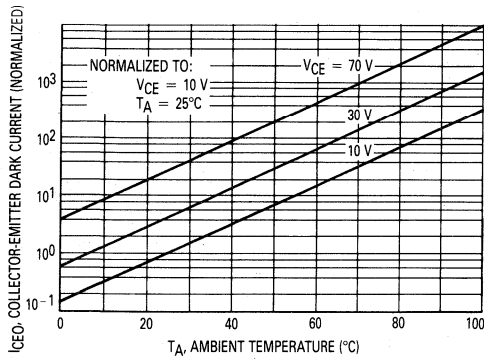

Figure 5. Dark Current versus Ambient Temperature

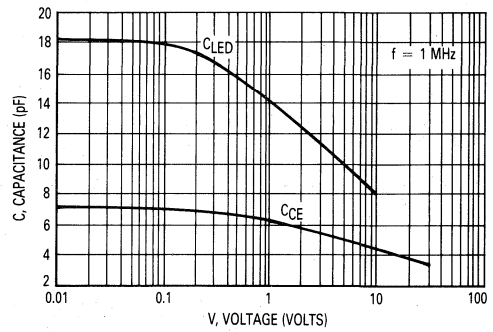



Figure 6. Capacitance versus Voltage

5

Small Outline Optoisolators Transistor Output

These devices consist of a gallium arsenide infrared emitting diode optically coupled to a monolithic silicon phototransistor detector, in a surface mountable, small outline, plastic package. They are ideally suited for high density applications, and eliminate the need for through-the-board mounting.

- Convenient Plastic SOIC-8 Surface Mountable Package Style
- Standard SOIC-8 Footprint, with .050" Lead Spacing
- Shipped in Tape and Reel, which Conforms to EIA Standard RS481A
- Compatible with Dual Wave, Vapor Phase and IR Reflow Soldering
- High Input-Output Isolation of 2500 Vac (rms) Guaranteed
- UL Recognized  File #E54915

Ordering Information:

- To obtain MOC211, 212, 213 in Tape and Reel, add R1 or R2 suffix to device numbers as follows:
 R1-500 units on 7" reel
 R2-2500 units on 13" reel
- To obtain MOC211, 212, 213 in quantities of 75 (shipped in sleeves) — No Suffix

Marking Information:

- MOC211 = 211
- MOC212 = 212
- MOC213 = 213

Applications:

- General Purpose Switching Circuits
- Interfacing and coupling systems of different potentials and impedances
- Regulation Feedback Circuits
- Monitor and Detection Circuits

MAXIMUM RATINGS (T_A = 25°C unless otherwise noted)

Rating	Symbol	Value	Unit
INPUT LED			
Forward Current — Continuous	I _F	60	mA
Forward Current — Peak (PW = 100 μs, 120 pps)	I _{F(pk)}	1.0	A
Reverse Voltage	V _R	6.0	V
LED Power Dissipation @ T _A = 25°C Derate above 25°C	P _D	90 0.8	mW mW/°C
OUTPUT TRANSISTOR			
Collector-Emitter Voltage	V _{CEO}	30	V
Collector-Base Voltage	V _{CB0}	70	V
Emitter-Collector Voltage	V _{ECO}	7.0	V
Collector Current — Continuous	I _C	150	mA
Detector Power Dissipation @ T _A = 25°C Derate above 25°C	P _D	150 1.76	mW mW/°C

(continued)

MOC211

[CTR = 20% Min]

MOC212

[CTR = 50% Min]

MOC213

[CTR = 100% Min]

Motorola Preferred Devices
 STYLE 1 PLASTIC

**SMALL OUTLINE
 OPTOISOLATORS
 TRANSISTOR OUTPUT**

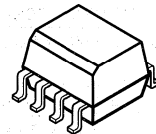

CASE 846-01

SCHEMATIC

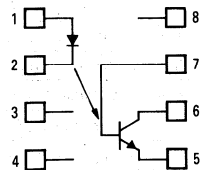

- 1: LED ANODE
- 2: LED CATHODE
- 3: NO CONNECTION
- 4: NO CONNECTION
- 5: EMITTER
- 6: COLLECTOR
- 7: BASE
- 8: NO CONNECTION

MOC211, MOC212, MOC213

MAXIMUM RATINGS — continued ($T_A = 25^\circ\text{C}$ unless otherwise noted)

Rating	Symbol	Value	Unit
TOTAL DEVICE			
Input-Output Isolation Voltage (1) (60 Hz, 1.0 sec. duration)	V_{ISO}	2500	$V_{ac}(rms)$
Total Device Power Dissipation @ $T_A = 25^\circ\text{C}$ Derate above 25°C	P_D	150 2.94	mW mW/ $^\circ\text{C}$
Ambient Operating Temperature Range	T_A	-55 to +100	$^\circ\text{C}$
Storage Temperature Range	T_{stg}	-55 to +150	$^\circ\text{C}$
Lead Soldering Temperature (1/16" from case, 10 sec. duration)	—	260	$^\circ\text{C}$

ELECTRICAL CHARACTERISTICS ($T_A = 25^\circ\text{C}$ unless otherwise noted)

Characteristic	Symbol	Min	Typ	Max	Unit
INPUT LED					
Forward Voltage ($I_F = 10\text{ mA}$)	V_F	—	1.15	1.5	V
Reverse Leakage Current ($V_R = 6.0\text{ V}$)	I_R	—	0.1	100	μA
Capacitance	C	—	18	—	pF

OUTPUT TRANSISTOR

Collector-Emitter Dark Current ($V_{CE} = 10\text{ V}$, $T_A = 25^\circ\text{C}$)	I_{CEO1}	—	1.0	50	nA
	I_{CEO2}	—	1.0	—	μA
Collector-Emitter Breakdown Voltage ($I_C = 100\ \mu\text{A}$)	$V_{(BR)CEO}$	30	90	—	V
Emitter-Collector Breakdown Voltage ($I_E = 100\ \mu\text{A}$)	$V_{(BR)ECO}$	7.0	7.8	—	V
Collector-Emitter Capacitance ($f = 1.0\text{ MHz}$, $V_{CE} = 0$)	C_{CE}	—	7.0	—	pF

COUPLED

Output Collector Current ($I_F = 10\text{ mA}$, $V_{CE} = 10\text{ V}$)	MOC211 MOC212 MOC213	I_C	2.0 5.0 10	6.5 9.0 14	— — —	mA
Collector-Emitter Saturation Voltage ($I_C = 2.0\text{ mA}$, $I_F = 10\text{ mA}$)		$V_{CE(sat)}$	—	0.15	0.4	V
Turn-On Time ($I_C = 2.0\text{ mA}$, $V_{CC} = 10\text{ V}$, $R_L = 100\ \Omega$)		t_{on}	—	7.5	—	μs
Turn-Off Time ($I_C = 2.0\text{ mA}$, $V_{CC} = 10\text{ V}$, $R_L = 100\ \Omega$)		t_{off}	—	5.7	—	μs
Rise Time ($I_C = 2.0\text{ mA}$, $V_{CC} = 10\text{ V}$, $R_L = 100\ \Omega$)		t_r	—	3.2	—	μs
Fall Time ($I_C = 2.0\text{ mA}$, $V_{CC} = 10\text{ V}$, $R_L = 100\ \Omega$)		t_f	—	4.7	—	μs
Isolation Voltage ($f = 60\text{ Hz}$, $t = 1.0\text{ sec.}$)		V_{ISO}	2500	—	—	$V_{ac}(rms)$
Isolation Resistance ($V_{I-O} = 500\text{ V}$)		R_{ISO}	10^{11}	—	—	Ω
Isolation Capacitance ($V_{I-O} = 0$, $f = 1.0\text{ MHz}$)		C_{ISO}	—	0.2	—	pF

(1) Input-Output Isolation Voltage, V_{ISO} , is an internal device dielectric breakdown rating. For this test, pins 1 and 2 are common, and pins 5, 6 and 7 are common.

TYPICAL CHARACTERISTICS

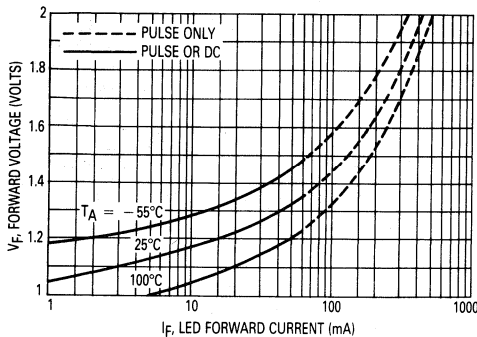

Figure 1. LED Forward Voltage versus Forward Current

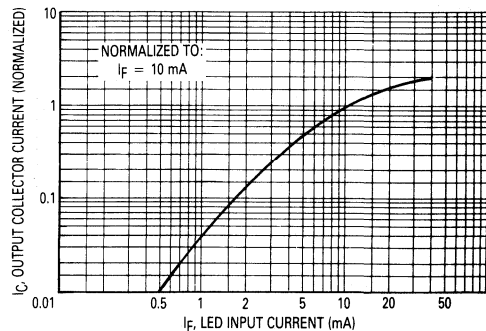

Figure 2. Output Current versus Input Current

MOC211, MOC212, MOC213

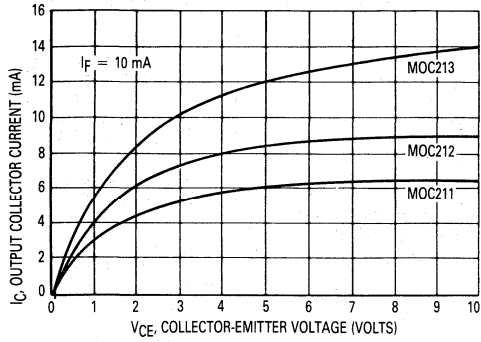

Figure 3. Output Current versus Collector-Emitter Voltage

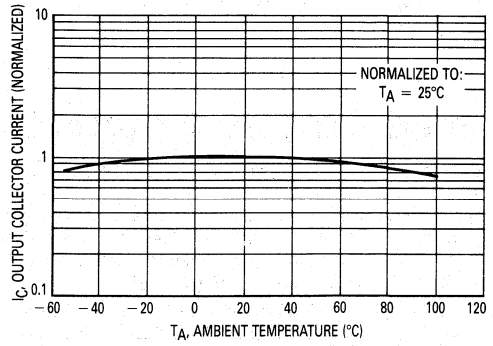

Figure 4. Output Current versus Ambient Temperature

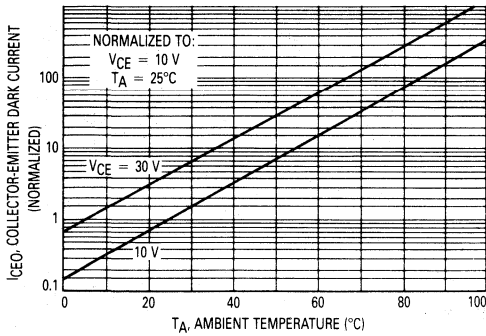

Figure 5. Dark Current versus Ambient Temperature

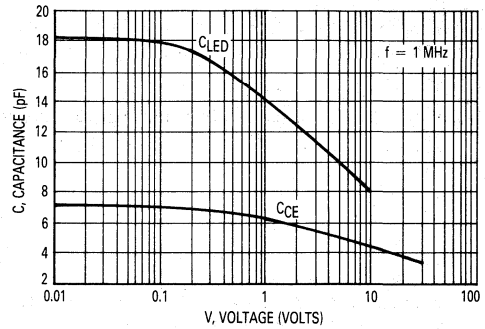



Figure 6. Capacitance versus Voltage

Small Outline Optoisolators Transistor Output (Low Input Current)

These devices consist of a gallium arsenide infrared emitting diode optically coupled to a monolithic silicon phototransistor detector, in a surface mountable, small outline, plastic package. They are ideally suited for high density applications, and eliminate the need for through-the-board mounting.

- Convenient Plastic SOIC-8 Surface Mountable Package Style
- Low LED Input Current Required, for Easier Logic Interfacing
- Standard SOIC-8 Footprint, with .050" Lead Spacing
- Shipped in Tape and Reel, which Conforms to EIA Standard RS481A
- Compatible with Dual Wave, Vapor Phase and IR Reflow Soldering
- High Input-Output Isolation of 2500 Vac (rms) Guaranteed
- UL Recognized  File #E54915

Ordering Information:

- To obtain MOC215, 216, 217 in Tape and Reel, add R1 or R2 suffix to device numbers as follows:
 R1-500 units on 7" reel
 R2-2500 units on 13" reel
- To obtain MOC215, 216, 217 in quantities of 75 (shipped in sleeves) — No Suffix

Marking Information:

- MOC215 = 215
- MOC216 = 216
- MOC217 = 217

Applications:

- Low power Logic Circuits
- Interfacing and coupling systems of different potentials and impedances
- Telecommunications equipment
- Portable electronics

MAXIMUM RATINGS ($T_A = 25^\circ\text{C}$ unless otherwise noted)

Rating	Symbol	Value	Unit
INPUT LED			
Forward Current — Continuous	I_F	60	mA
Forward Current — Peak (PW = 100 μs , 120 pps)	$I_F(\text{pk})$	1.0	A
Reverse Voltage	V_R	6.0	V
LED Power Dissipation @ $T_A = 25^\circ\text{C}$ Derate above 25°C	P_D	90 0.8	mW mW/ $^\circ\text{C}$
OUTPUT TRANSISTOR			
Collector-Emitter Voltage	V_{CEO}	30	V
Collector-Base Voltage	V_{CBO}	70	V
Emitter-Collector Voltage	V_{ECO}	7.0	V
Collector Current — Continuous	I_C	150	mA
Detector Power Dissipation @ $T_A = 25^\circ\text{C}$ Derate above 25°C	P_D	150 1.76	mW mW/ $^\circ\text{C}$

(continued)

MOC215

[CTR = 20% Min]

MOC216

[CTR = 50% Min]

MOC217

[CTR = 100% Min]

Motorola Preferred Devices
 STYLE 1 PLASTIC

SMALL OUTLINE OPTOISOLATORS TRANSISTOR OUTPUT

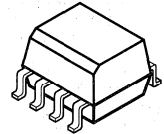

CASE 846-01

SCHEMATIC

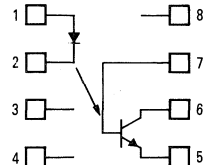

- 1: LED ANODE
- 2: LED CATHODE
- 3: NO CONNECTION
- 4: NO CONNECTION
- 5: EMITTER
- 6: COLLECTOR
- 7: BASE
- 8: NO CONNECTION

MOC215, MOC216, MOC217

MAXIMUM RATINGS — continued ($T_A = 25^\circ\text{C}$ unless otherwise noted)

Rating	Symbol	Value	Unit
TOTAL DEVICE			
Input-Output Isolation Voltage (1 (60 Hz, 1.0 sec. duration)	V_{ISO}	2500	Vac(rms)
Total Device Power Dissipation @ $T_A = 25^\circ\text{C}$ Derate above 25°C	P_D	150 2.94	mW mW/ $^\circ\text{C}$
Ambient Operating Temperature Range	T_A	-55 to +100	$^\circ\text{C}$
Storage Temperature Range	T_{stg}	-55 to +150	$^\circ\text{C}$
Lead Soldering Temperature (1/16" from case, 10 sec. duration)	—	260	$^\circ\text{C}$

ELECTRICAL CHARACTERISTICS ($T_A = 25^\circ\text{C}$ unless otherwise noted)

Characteristic	Symbol	Min	Typ	Max	Unit
----------------	--------	-----	-----	-----	------

INPUT LED

Forward Voltage ($I_F = 1.0\text{ mA}$)	V_F	—	1.05	1.3	V
Reverse Leakage Current ($V_R = 6.0\text{ V}$)	I_R	—	0.1	100	μA
Capacitance	C	—	18	—	pF

OUTPUT TRANSISTOR

Collector-Emitter Dark Current	$(V_{CE} = 5.0\text{ V}, T_A = 25^\circ\text{C})$	I_{CEO1}	—	1.0	50	nA
	$(V_{CE} = 5.0\text{ V}, T_A = 100^\circ\text{C})$	I_{CEO2}	—	1.0	—	μA
Collector-Emitter Breakdown Voltage ($I_C = 100\ \mu\text{A}$)	$V_{(BR)CEO}$	30	90	—	V	
Emitter-Collector Breakdown Voltage ($I_E = 100\ \mu\text{A}$)	$V_{(BR)ECO}$	7.0	7.8	—	V	
Collector-Emitter Capacitance ($f = 1.0\text{ MHz}, V_{CE} = 0$)	C_{CE}	—	7.0	—	pF	

COUPLED

Output Collector Current ($I_F = 1.0\text{ mA}, V_{CE} = 5.0\text{ V}$)	MOC215	I_C	200	500	—	μA
	MOC216		500	800	—	μA
	MOC217		1.0	1.3	—	mA
Collector-Emitter Saturation Voltage ($I_C = 100\ \mu\text{A}, I_F = 1.0\text{ mA}$)	$V_{CE(sat)}$	—	0.35	0.4	V	
Turn-On Time ($I_C = 2.0\text{ mA}, V_{CC} = 10\text{ V}, R_L = 100\ \Omega$)	t_{on}	—	7.5	—	μs	
Turn-Off Time ($I_C = 2.0\text{ mA}, V_{CC} = 10\text{ V}, R_L = 100\ \Omega$)	t_{off}	—	5.7	—	μs	
Rise Time ($I_C = 2.0\text{ mA}, V_{CC} = 10\text{ V}, R_L = 100\ \Omega$)	t_r	—	3.2	—	μs	
Fall Time ($I_C = 2.0\text{ mA}, V_{CC} = 10\text{ V}, R_L = 100\ \Omega$)	t_f	—	4.7	—	μs	
Isolation Voltage ($f = 60\text{ Hz}, t = 1.0\text{ sec.}$)	V_{ISO}	2500	—	—	Vac(rms)	
Isolation Resistance ($V_{I-O} = 500\text{ V}$)	R_{ISO}	10^{11}	—	—	Ω	
Isolation Capacitance ($V_{I-O} = 0, f = 1.0\text{ MHz}$)	C_{ISO}	—	0.2	—	pF	

(1) Input-Output Isolation Voltage, V_{ISO} , is an internal device dielectric breakdown rating. For this test, pins 1 and 2 are common, and pins 5, 6 and 7 are common.

TYPICAL CHARACTERISTICS

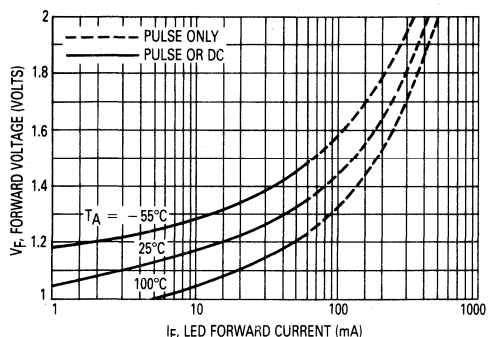

Figure 1. LED Forward Voltage versus Forward Current

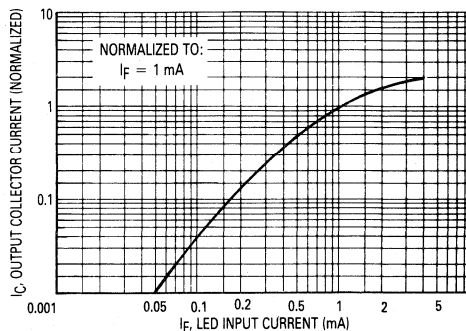

Figure 2. Output Current versus Input Current

MOC215, MOC216, MOC217

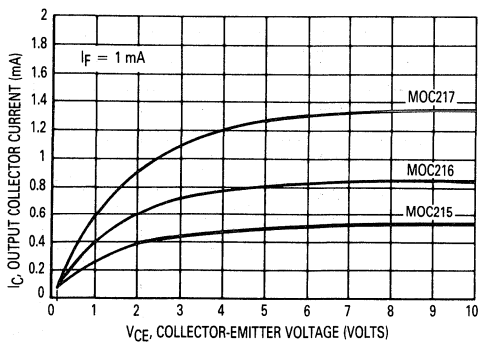

Figure 3. Output Current versus Collector-Emitter Voltage

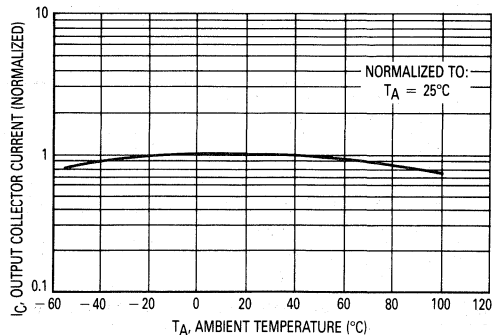

Figure 4. Output Current versus Ambient Temperature

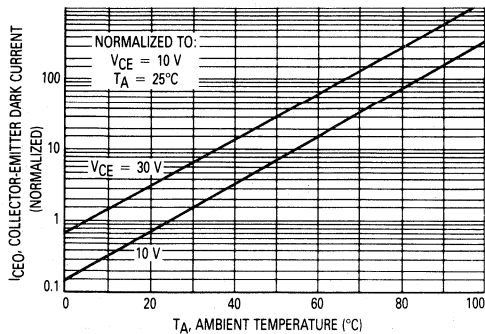

Figure 5. Dark Current versus Ambient Temperature

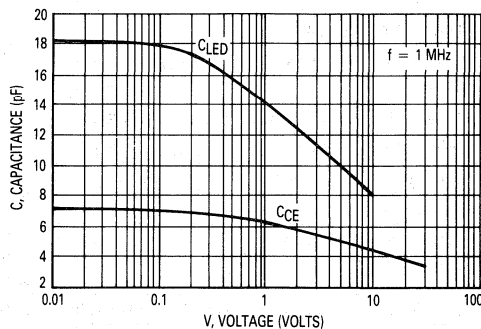



Figure 6. Capacitance versus Voltage

5

Small Outline Optoisolators Darlington Output

These devices consist of a gallium arsenide infrared emitting diode optically coupled to a monolithic silicon photodarlington detector, in a surface mountable, small outline, plastic package. They are ideally suited for high density applications, and eliminate the need for through-the-board mounting.

- Convenient Plastic SOIC-8 Surface Mountable Package Style
- High Current Transfer Ratio (CTR) at Low LED Input Current, for Easier Logic Interfacing
- Standard SOIC-8 Footprint, with .050" Lead Spacing
- Shipped in Tape and Reel, which Conforms to EIA Standard RS481A
- Compatible with Dual Wave, Vapor Phase and IR Reflow Soldering
- High Input-Output Isolation of 2500 Vac (rms) Guaranteed
- UL Recognized  File #E54915

Ordering Information:

- To obtain MOC221, 222, 223 in Tape and Reel, add R1 or R2 suffix to device numbers as follows:
 R1-500 units on 7" reel
 R2-2500 units on 13" reel
- To obtain MOC221, 222, 223 in quantities of 75 (shipped in sleeves) — No Suffix

Marking Information:

- MOC221 = 221
- MOC222 = 222
- MOC223 = 223

Applications:

- Low power Logic Circuits
- Interfacing and coupling systems of different potentials and impedances
- Telecommunications equipment
- Portable electronics

MAXIMUM RATINGS (T_A = 25°C unless otherwise noted)

Rating	Symbol	Value	Unit
INPUT LED			
Forward Current — Continuous	I _F	60	mA
Forward Current — Peak (PW = 100 μs, 120 pps)	I _{F(pk)}	1.0	A
Reverse Voltage	V _R	6.0	V
LED Power Dissipation @ T _A = 25°C Derate above 25°C	P _D	90 0.8	mW mW/°C
OUTPUT DARLINGTON			
Collector-Emitter Voltage	V _{CEO}	30	V
Collector-Base Voltage	V _{CBO}	70	V
Emitter-Collector Voltage	V _{ECO}	7.0	V
Collector Current — Continuous	I _C	150	mA
Detector Power Dissipation @ T _A = 25°C Derate above 25°C	P _D	150 1.76	mW mW/°C

(continued)

MOC221

[CTR = 100% Min]

MOC222

[CTR = 200% Min]

MOC223

[CTR = 500% Min]

Motorola Preferred Devices
 STYLE 1 PLASTIC

SMALL OUTLINE OPTOISOLATORS DARLINGTON OUTPUT

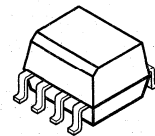

CASE 846-01

SCHEMATIC

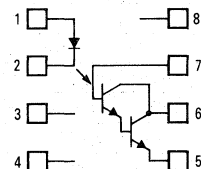

- 1: LED ANODE
- 2: LED CATHODE
- 3: NO CONNECTION
- 4: NO CONNECTION
- 5: EMITTER
- 6: COLLECTOR
- 7: BASE
- 8: NO CONNECTION

MOC221, MOC222, MOC223

MAXIMUM RATINGS — continued ($T_A = 25^\circ\text{C}$ unless otherwise noted)

Rating	Symbol	Value	Unit
TOTAL DEVICE			
Input-Output Isolation Voltage (1) (60 Hz, 1.0 sec. duration)	V_{ISO}	2500	Vac(rms)
Total Device Power Dissipation @ $T_A = 25^\circ\text{C}$ Derate above 25°C	P_D	150 2.94	mW mW/ $^\circ\text{C}$
Ambient Operating Temperature Range	T_A	-55 to +100	$^\circ\text{C}$
Storage Temperature Range	T_{stg}	-55 to +150	$^\circ\text{C}$
Lead Soldering Temperature (1/16" from case, 10 sec. duration)	—	260	$^\circ\text{C}$

ELECTRICAL CHARACTERISTICS ($T_A = 25^\circ\text{C}$ unless otherwise noted)

Characteristic	Symbol	Min	Typ	Max	Unit
INPUT LED					
Forward Voltage ($I_F = 1.0\text{ mA}$)	V_F	—	1.05	1.3	V
Reverse Leakage Current ($V_R = 6.0\text{ V}$)	I_R	—	0.1	100	μA
Capacitance	C	—	18	—	pF

OUTPUT DARLINGTON

Collector-Emitter Dark Current ($V_{CE} = 5.0\text{ V}, T_A = 25^\circ\text{C}$)	I_{CEO1}	—	1.0	50	nA
	($V_{CE} = 5.0\text{ V}, T_A = 100^\circ\text{C}$)	I_{CEO2}	—	1.0	—
Collector-Emitter Breakdown Voltage ($I_C = 100\ \mu\text{A}$)	$V_{(BR)CEO}$	30	90	—	V
Emitter-Collector Breakdown Voltage ($I_E = 100\ \mu\text{A}$)	$V_{(BR)ECO}$	7.0	7.8	—	V
Collector-Emitter Capacitance ($f = 1.0\text{ MHz}, V_{CE} = 0$)	C_{CE}	—	5.5	—	pF

COUPLED

Output Collector Current ($I_F = 1.0\text{ mA}, V_{CE} = 5.0\text{ V}$)	MOC221 MOC222 MOC223	I_C	1.0 2.0 5.0	2.0 4.0 10	— — —	mA
Collector-Emitter Saturation Voltage ($I_C = 500\ \mu\text{A}, I_F = 1.0\text{ mA}$)		$V_{CE(sat)}$	—	—	1.0	V
Turn-On Time ($I_F = 5.0\text{ mA}, V_{CC} = 10\text{ V}, R_L = 100\ \Omega$)		t_{on}	—	3.5	—	μs
Turn-Off Time ($I_F = 5.0\text{ mA}, V_{CC} = 10\text{ V}, R_L = 100\ \Omega$)		t_{off}	—	95	—	μs
Rise Time ($I_F = 5.0\text{ mA}, V_{CC} = 10\text{ V}, R_L = 100\ \Omega$)		t_r	—	1.0	—	μs
Fall Time ($I_F = 5.0\text{ mA}, V_{CC} = 10\text{ V}, R_L = 100\ \Omega$)		t_f	—	2.0	—	μs
Isolation Voltage ($f = 60\text{ Hz}, t = 1.0\text{ sec.}$)		V_{ISO}	2500	—	—	Vac(rms)
Isolation Resistance ($V_{I-O} = 500\text{ V}$)		R_{ISO}	10^{11}	—	—	Ω
Isolation Capacitance ($V_{I-O} = 0, f = 1.0\text{ MHz}$)		C_{ISO}	—	0.2	—	pF

(1) Input-Output Isolation Voltage, V_{ISO} , is an internal device dielectric breakdown rating. For this test, pins 1 and 2 are common, and pins 5, 6 and 7 are common.

TYPICAL CHARACTERISTICS

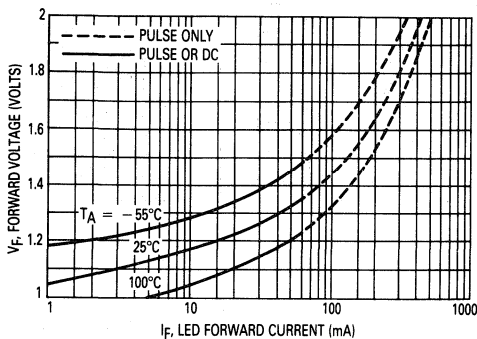

Figure 1. LED Forward Voltage versus Forward Current

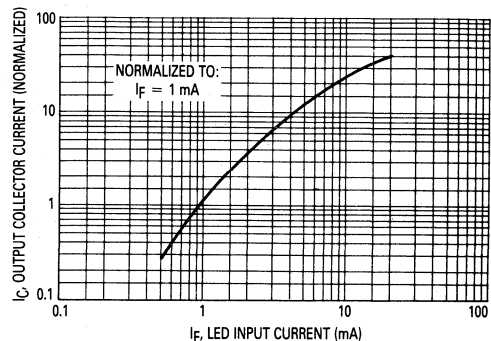

Figure 2. Output Current versus Input Current

MOC221, MOC222, MOC223

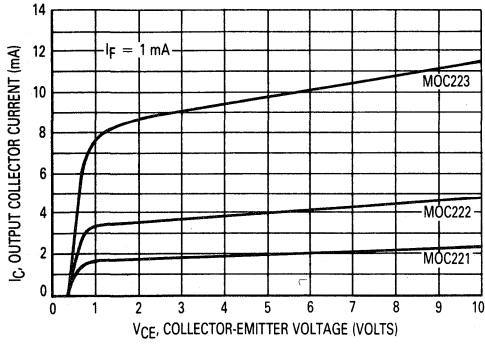

Figure 3. Output Current versus Collector-Emitter Voltage

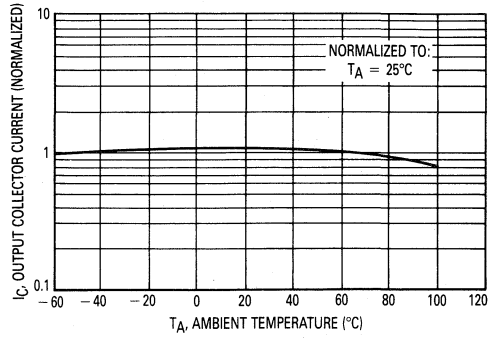

Figure 4. Output Current versus Ambient Temperature

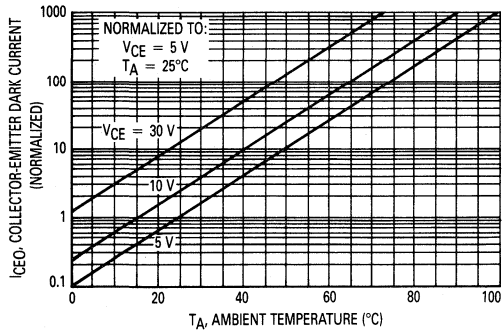

Figure 5. Dark Current versus Ambient Temperature

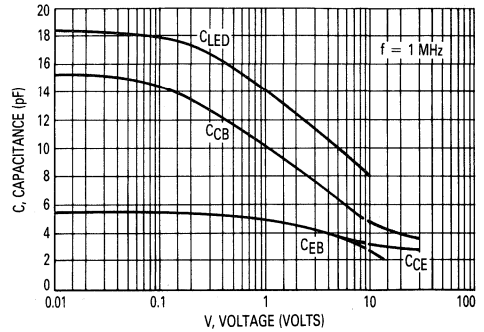
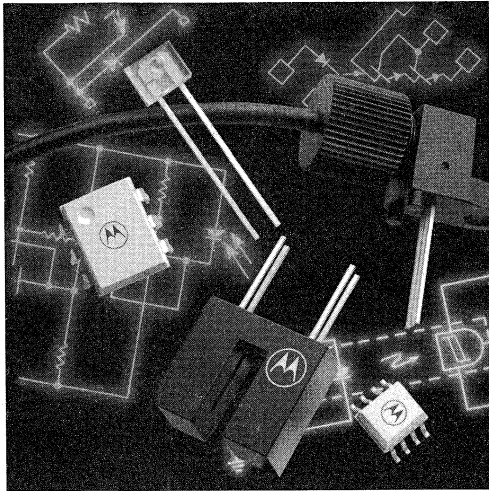

Figure 6. Capacitance versus Voltage



Section Six

POWER OPTO™ Isolators

General Information	6-2
MOC2A40-10/F	6-3
MOC2A40-5/F	6-3
MOC2A60-10/F	6-8
MOC2A60-5/F	6-8
Applications Information	6-13
AN1511	6-13

POWER OPTO™

ISOLATORS

General Information

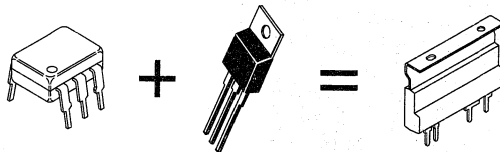

Equivalent Discrete Semiconductors

The MOC2A40 and MOC2A60 Series are the first members of the POWER OPTO™ Isolator family from Motorola. The MOC2A40/MOC2A60 are 2 Amp @ 40°C/400 Vac [pk]/Zero-Crossing/Optically Coupled Triacs. These isolated AC output devices are ruggedized to survive the harsh operating environments inherent in Industrial Controller applications. Additionally, their thermally optimized SIP package profile allows for high density stacking on .200" centers, and can handle 2 Amps @ 40°C (Free-Air Rating) without the need for heatsinks, thermal grease, etc.

6

General Characteristics

- 2 Amp @ 40°C, Zero-Cross, Optically Coupled Triac.
- 3,750 Vac (rms) Isolation Voltage.
- Zero-Voltage Turn-on. Zero-current Turn-off.
- 60 Amp Single Cycle Surge Withstand Capability.
- Meets NEMA 2-230 & IEEE 472 Noise Immunity Standards.
- Guaranteed 400 V μ sec dv/dt (Static).
- Low 0.96 V (Typical) On-State Voltage.
- Thermally Efficient Package yields 8.0°C/W R θ JC.
- Single In-Line Package Mounts on .200" Centers for High Density Applications.
- U.L. Recognized. C.S.A. approved, V.D.E. (in process).

Types of Applications and Loads

- Programmable Logic Controllers
- Distributive Process Controls
- Industrial Controls & Automation Systems
- Temperature Controllers
- HVAC & Energy Management Systems
- Gaming Machines
- Vending Machines
- Gas Pumps
- Photocopiers
- AC Motor Starters
- EM Contactors
- AC Solenoids/Valves

Customer Benefits

- A World Class POWER OPTO™ Isolator
- Meets Isolation Requirements for V.D.E.
- Protects Loads from High In-rush Currents
- Robust Surge Withstand Performance
- Stability against Noise-Induced False Turn-on
- Good Inductive Load Switching Capability
- Generates 30–50% Less Heat than Competitive Devices
- No Heatsink, Grease or Hardware Required
- Allows for Optimal Channel Density in Programmable Controller Applications
- Global Regulatory Approvals

Literature

- Data Sheets **MOC2A40-10/D & MOC2A60-10/D**
- Sample Pack **KITMOC2A40-10/D KITMOC2A60-5/D**
- Evaluation Board **DEVB109**

**MOTOROLA
SEMICONDUCTOR
TECHNICAL DATA**

**POWER OPTO™ Isolator
2 Amp Zero-Cross Triac Output**

This device consists of a gallium arsenide infrared emitting diode optically coupled to a zero-cross triac driver circuit and a power triac. It is capable of driving a load of up to 2 amp (rms) directly, on line voltages from 20 to 140 volts ac (rms).

- Provides Normally Open Solid State A.C. Output With 2 Amp Rating
- 60 Amp Single Cycle Surge Capability
- Zero-Voltage Turn-on and Zero-Current Turn-off
- High Input-Output Isolation of 3750 vac (rms)
- Static dv/dt Rating of 400 Volts/μs Guaranteed
- 2 Amp Pilot Duty Rating Per UL508 ¶117 (Overload Test) and ¶118 (Endurance Test) [File No. 129224]
- CSA Approved [File No. CA77170-1]. VDE Approval in Process
- Exceeds NEMA 2-230 and IEEE472 Noise Immunity Test Requirements (See Fig.15)

DEVICE RATINGS (T_A = 25°C unless otherwise noted)

Rating	Symbol	Value	Unit
INPUT LED			
Forward Current — Maximum Continuous	I _F	50	mA
Forward Current — Maximum Peak (PW = 100μs, 120 pps)	I _{F(pk)}	1.0	A
Reverse Voltage — Maximum	V _R	6.0	V

OUTPUT TRIAC

Off-State Output Terminal Voltage — Maximum [1]	V _{DRM}	400	Vac(pk)
Recommended Operating Voltage Range (f = 47 – 63 Hz)	V _T	20 to 140	Vac(rms)
On-State Current Range (Free Air, Power Factor ≥ 0.3)	I _{T(rms)}	0.01 to 2.0	A
Non-Repitive Peak Overcurrent — Max (f = 60 Hz, t = 1.0 sec)	I _{TSM1}	24	A
Non-Repitive Single Cycle Surge Current — Maximum Peak (t = 16.7 ms)	I _{TSM2}	60	A
Main Terminal Fusing Current (t = 8.3 ms)	I ² _T	15	A ² sec
Load Power Factor Range	PF	0.3 to 1.0	—
Junction Temperature Range	T _J	- 40 to 125	°C

TOTAL DEVICE

Input-Output Isolation Voltage — Maximum [2] 47 – 63 Hz, 1 sec Duration	V _{ISO}	3750	Vac(rms)
Thermal Resistance — Power Triac Junction to Case (See Fig. 16)	R _{θJC}	8.0	°C/W
Ambient Operating Temperature Range	T _{oper}	- 40 to +100	°C
Storage Temperature Range	T _{stg}	- 40 to +150	°C
Lead Soldering Temperature — Maximum (1/16" From Case, 10 sec Duration)	—	260	°C

Notes:

- [1] Test voltages must be applied within dv/dt rating.
[2] Input-Output isolation voltage, V_{ISO}, is an internal device dielectric breakdown rating. For this test, pins 2, 3 and the heat tab are common, and pins 7 and 9 are common.

Preferred devices are Motorola recommended choices for future use and best overall value.

MOC2A40-10
MOC2A40-5

Motorola Preferred Devices

**OPTOISOLATOR
2 AMP ZERO CROSS
TRIAC OUTPUT
400 VOLTS**

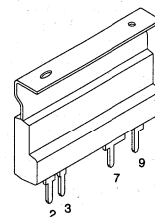

**CASE 417-02
PLASTIC PACKAGE
STYLE 2**

DEVICE SCHEMATIC

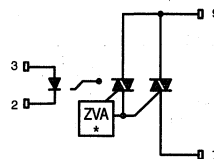

* Zero Voltage Activate Circuit

- 1, 4, 5, 6, 8, No Pin
- 2, LED Cathode
- 3, LED Anode
- 7, Main Terminal
- 9, Main Terminal

5K
MOC2A60-5 # 1,74

MOC2A40-10 • MOC2A40-5

ELECTRICAL CHARACTERISTICS (T_A = 25°C unless otherwise noted)

Characteristic	Symbol	Min	Typ	Max	Unit
INPUT LED					
Forward Voltage (I _F = 10 mA)	V _F	1.00	1.17	1.50	V
Reverse Leakage Current (V _R = 6.0 V)	I _R	—	1.0	100	μA
Capacitance	C	—	18	—	pF
OUTPUT TRIAC					
Off-State Leakage, Either Direction (I _F = 0, V _{DRM} = 400 V) T _A = 25°C T _A = 100°C	I _{DRM1} I _{DRM2}	— —	— —	10 1.0	μA mA
Critical Rate of Rise of Off-State Voltage (Static) V _{in} = 200 vac(pk) [1] [2]	dv/dt(s)	400	—	—	V/μs
Holding Current, Either Direction (I _F = 0, V _D = 12 V, I _T = 200 mA)	I _H	—	300	—	μA
COUPLED					
LED Trigger Current Required to Latch Output Either Direction (Main Terminal Voltage = 2.0 V) [3] [4]	MOC2A40-10 MOC2A40-5 I _{FT(on)} I _{FT(on)}	— —	7.0 3.5	10 5.0	mA mA
On-State Voltage, Either Direction (I _F = Rated I _{FT(on)} , I _{TM} = 2.0 A)	V _{TM}	—	0.96	1.3	V
Inhibit Voltage, Either Direction (I _F = Rated I _{FT(on)}) [5] (Main Terminal Voltage above which device will not Trigger)	V _{INH}	—	8.0	10	V
Commutating dv/dt (Rated V _{DRM} , I _T = 30 mA – 2.0 A(rms), T _A = -40 ± 100°C, f = 60 Hz) [2]	dv/dt (c)	5.0	—	—	V/μs
Common-mode Input-Output dv/dt [2]	dv/dt(cm)	—	40,000	—	V/μs
Input-Output Capacitance (V = 0, f = 1.0 MHz)	C _{ISO}	—	1.3	—	pF
Isolation Resistance (V _{I-O} = 500 V)	R _{ISO}	10 ⁹	10 ¹⁴	—	Ω

Notes:

- [1] Per EIA/NARM standard RS-443, with V_p = 200 V, which is the instantaneous peak of the maximum operating voltage.
- [2] Additional dv/dt information, including test methods, can be found in Motorola applications note AN1048/D, Figure 43.
- [3] All devices are guaranteed to trigger at an I_F value less than or equal to the max I_{FT}. Therefore, the recommended operating I_F lies between the device's maximum I_{FT} (on) limit and the Maximum Rating of 50 mA.
- [4] Current-limiting resistor required in series with LED.
- [5] Also known as "Zero Voltage Turn-On".

TYPICAL CHARACTERISTICS

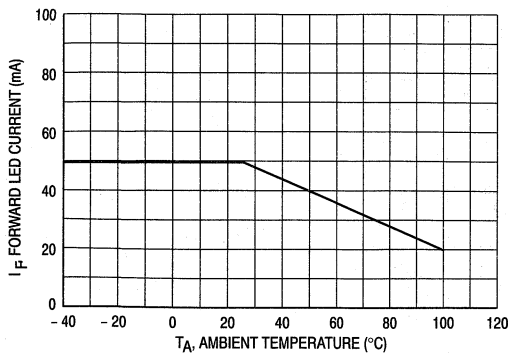

Figure 1. Maximum Allowable Forward LED Current versus Ambient Temperature

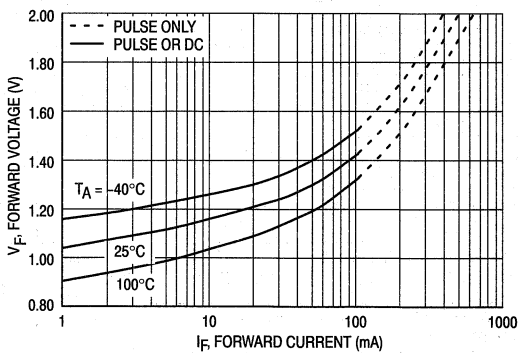

Figure 2. LED Forward Voltage versus LED Forward Current

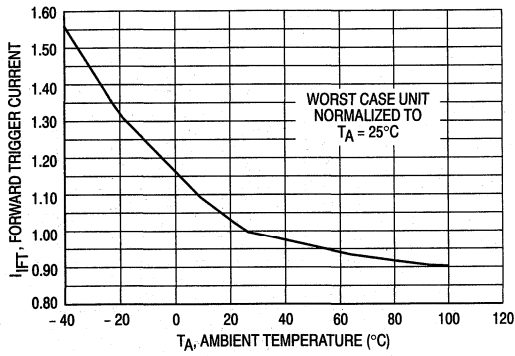

Figure 3. Forward LED Trigger Current versus Ambient Temperature

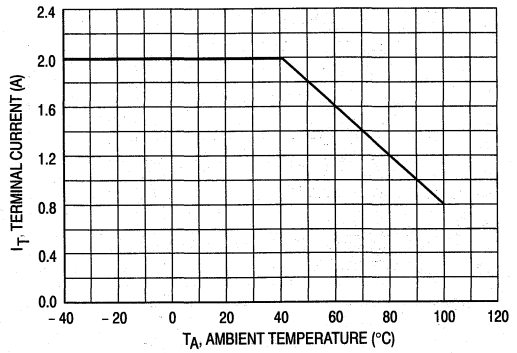

Figure 4. Maximum Allowable On-State RMS Output Current (Free Air) versus Ambient Temperature

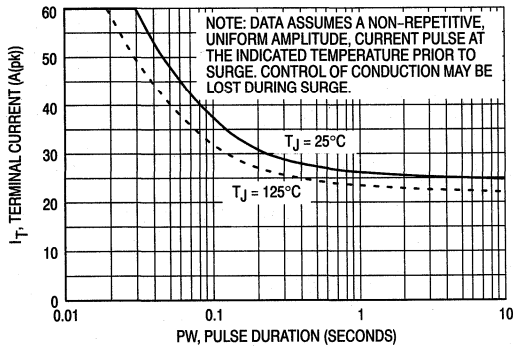

Figure 5. Maximum Allowable Surge Current versus Pulse Duration

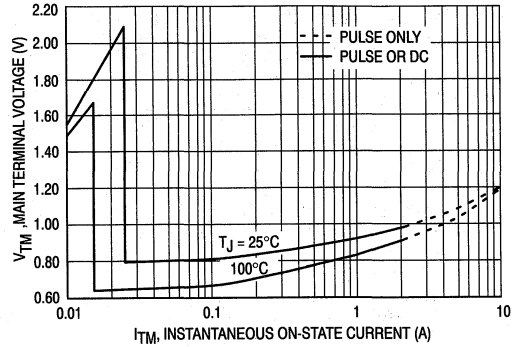

Figure 6. On-State Voltage Drop versus Output Terminal Current

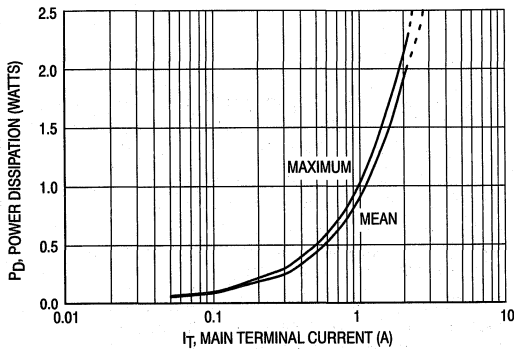

Figure 7. Power Dissipation versus Main Terminal Current

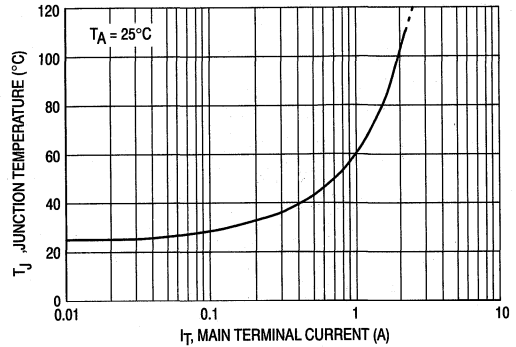

Figure 8. Junction Temperature versus Main Terminal RMS Current (Free Air)

6

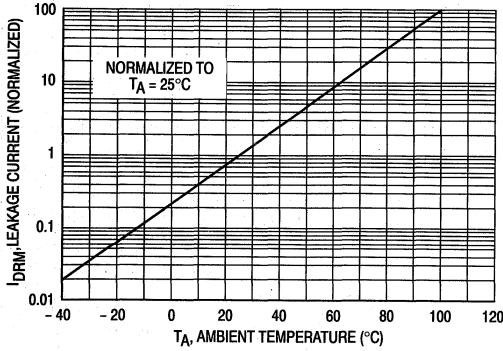

Figure 9. Leakage With LED Off versus Ambient Temperature

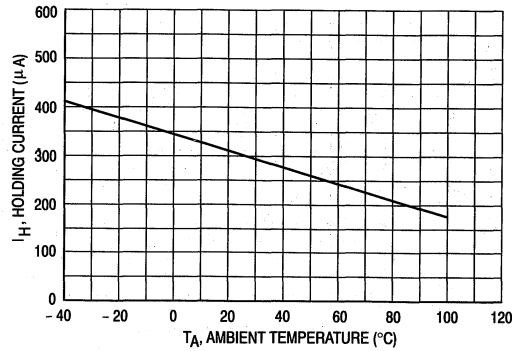

Figure 10. Holding Current versus Ambient Temperature

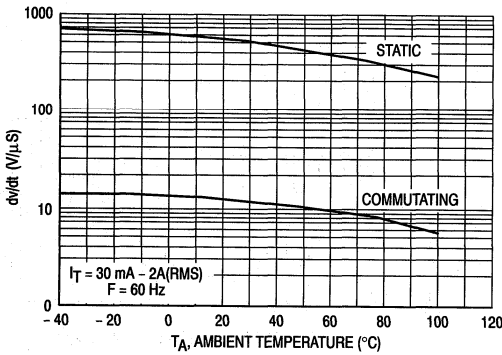

Figure 11. dv/dt versus Ambient Temperature

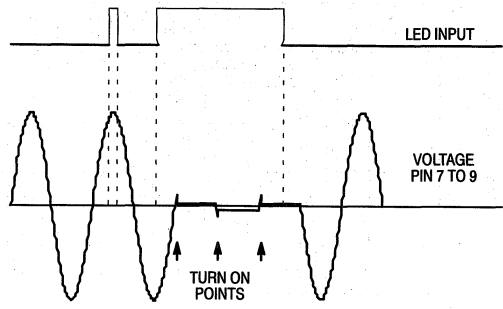

Figure 12. Operating Waveforms

*ZERO VOLTAGE ACTIVATE CIRCUIT

Select the value of R1 according to the following formulas:

- [1] $R1 = (V_{CC} - V_F) / \text{Max. } I_{FT} \text{ (on) per spec.}$
- [2] $R1 = (V_{CC} - V_F) / 0.050$

Typical values for C1 and R2 are 0.01 μF and 39 Ω , respectively. You may adjust these values for specific applications. The maximum recommended value of C1 is 0.022 μF . See application note AN1048 for additional information on component values.

The MOV may or may not be needed depending upon the characteristics of the applied ac line voltage. For applications where line spikes may exceed the 400 V rating of the MOC2A40, an MOV is required.

Figure 13. Typical Application Circuit

6

Use care to maintain the minimum spacings as shown. Safety and regulatory requirements dictate a minimum of 8.0 mm between the closest points between input and output conducting paths, Pins 3 and 7. Also, 0.070 inches distance is required between the two output Pins, 7 and 9.

Keep pad sizes on Pins 7 and 9 as large as possible for optimal performance.

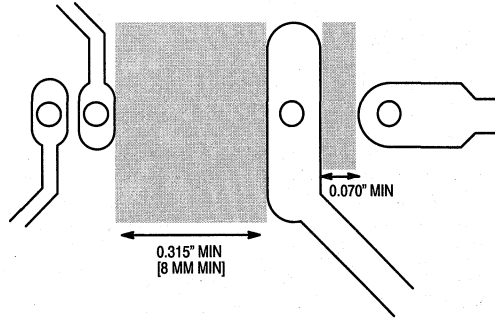

Figure 14. PC Board Layout Recommendations

Each device, when installed in the circuit shown in Figure 15, shall be capable of passing the following conducted noise tests:

- IEEE 472 (2.5 KV)
- Lamp Dimmer (NEMA Part DC33, § 3.4.2.1)
- NEMA ICS 2-230.45 Showering Arc
- MIL-STD-461A CS01, CS02 and CS06

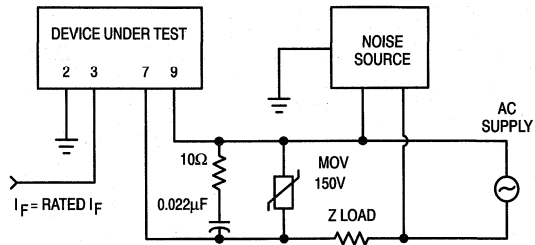
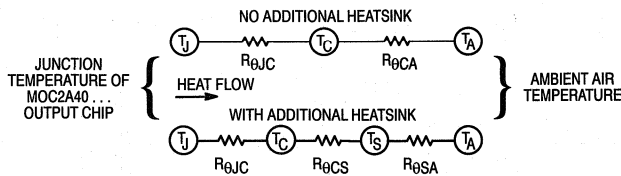

Figure 15. Test Circuit for Conducted Noise Tests



Terms in the model signify:

- T_A = Ambient temperature
- T_S = Optional additional heat sink temperature
- T_C = Case temperature
- T_J = Junction temperature
- P_D = Power dissipation
- $R_{\theta SA}$ = Thermal resistance, heat sink to ambient
- $R_{\theta CA}$ = Thermal resistance, case to ambient
- $R_{\theta CS}$ = Thermal resistance, heat sink to case
- $R_{\theta JC}$ = Thermal resistance, junction to case

Values for thermal resistance components are: $R_{\theta CA} = 36^\circ\text{C/W/in}$ maximum
 $R_{\theta JC} = 8.0^\circ\text{C/W}$ maximum

The design of any additional heatsink will determine the values of $R_{\theta SA}$ and $R_{\theta CS}$.

$$T_C - T_A = P_D (R_{\theta CA})$$

$$= P_D (R_{\theta JC}) + R_{\theta SA}, \text{ where } P_D = \text{Power Dissipation in Watts.}$$

Figure 16. Approximate Thermal Circuit Model

Thermal measurements of $R_{\theta JC}$ are referenced to the point on the heat tab indicated with an 'X'. Measurements should be taken with device orientated along its vertical axis.

MOTOROLA SEMICONDUCTOR TECHNICAL DATA

Advance Information POWER OPTO™ Isolator 2 Amp Zero-Cross Triac Output

This device consists of a gallium arsenide infrared emitting diode optically coupled to a zero-cross triac driver circuit and a power triac. It is capable of driving a load of up to 2 amp (rms) directly, on line voltages from 20 to 280 volts ac (rms).

- Provides Normally Open Solid State A.C. Output With 2 Amp Rating
- 60 Amp Single Cycle Surge Capability
- Zero-Voltage Turn-on and Zero-Current Turn-off
- High Input-Output Isolation of 3750 vac (rms)
- Static dv/dt Rating of 400 Volts/μs Guaranteed
- 2 Amp Pilot Duty Rating Per UL508 ¶117 (Overload Test) and ¶118 (Endurance Test)  [File No. 129224]
- CSA Approved [File No. CA77170-1]. VDE Approval in Process
- Exceeds NEMA 2-230 and IEEE472 Noise Immunity Test Requirements (See Fig.15)

DEVICE RATINGS (T_A = 25°C unless otherwise noted)

Rating	Symbol	Value	Unit
INPUT LED			
Forward Current — Maximum Continuous	I _F	50	mA
Forward Current — Maximum Peak (PW = 100μs, 120 pps)	I _{F(pk)}	1.0	A
Reverse Voltage — Maximum	V _R	6.0	V

OUTPUT TRIAC

Off-State Output Terminal Voltage — Maximum [1]	V _{DRM}	600	Vac(pk)
Recommended Operating Voltage Range (f = 47 – 63 Hz)	V _T	20 to 280	Vac(rms)
On-State Current Range (Free Air, Power Factor ≥ 0.3)	I _{T(rms)}	0.01 to 2.0	A
Non-Repetitive Peak Overcurrent — Max (f = 60 Hz, t = 1.0 sec)	I _{TSM1}	24	A
Non-Repetitive Single Cycle Surge Current — Maximum Peak (t = 16.7 ms)	I _{TSM2}	60	A
Main Terminal Fusing Current (t = 8.3 ms)	i ² _T	15	A ² sec
Load Power Factor Range	PF	0.3 to 1.0	—
Junction Temperature Range	T _J	-40 to 125	°C

TOTAL DEVICE

Input-Output Isolation Voltage — Maximum [2] 47 – 63 Hz, 1 sec Duration	V _{ISO}	3750	Vac(rms)
Thermal Resistance — Power Triac Junction to Case (See Fig. 16)	R _{θJC}	8.0	°C/W
Ambient Operating Temperature Range	T _{oper}	-40 to +100	°C
Storage Temperature Range	T _{stg}	-40 to +150	°C
Lead Soldering Temperature — Maximum (1/16" From Case, 10 sec Duration)	—	260	°C

Notes:

[1] Test voltages must be applied within dv/dt rating.

[2] Input-Output Isolation voltage, V_{ISO}, is an internal device dielectric breakdown rating. For this test, pins 2, 3 and the heat tab are common, and pins 7 and 9 are common.

This document contains information on a new product. Specifications and information herein are subject to change without notice.

POWER OPTO is a trademark of Motorola Inc.

Preferred devices are Motorola recommended choices for future use and best overall value.

MOC2A60-10 MOC2A60-5

Motorola Preferred Devices

OPTOISOLATOR 2 AMP ZERO CROSS TRIAC OUTPUT 600 VOLTS

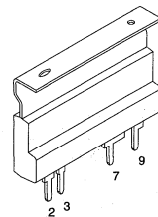

CASE 417-02
PLASTIC PACKAGE
STYLE 2

DEVICE SCHEMATIC

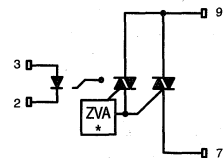

* Zero Voltage Activate Circuit

- 1, 4, 5, 6, 8, No Pin
- 2, LED Cathode
- 3, LED Anode
- 7, Main Terminal
- 9, Main Terminal

MOC2A60-10 • MOC2A60-5

ELECTRICAL CHARACTERISTICS (T_A = 25°C unless otherwise noted)

Characteristic	Symbol	Min	Typ	Max	Unit
----------------	--------	-----	-----	-----	------

INPUT LED

Forward Voltage (I _F = 10 mA)	V _F	1.00	1.17	1.50	V
Reverse Leakage Current (V _R = 6.0 V)	I _R	—	1.0	100	μA
Capacitance	C	—	18	—	pF

OUTPUT TRIAC

Off-State Leakage, Either Direction (I _F = 0, V _{DRM} = 600 V)	T _A = 25°C	I _{DRM1}	—	—	10	μA
	T _A = 100°C	I _{DRM2}	—	—	1.0	mA
Critical Rate of Rise of Off-State Voltage (Static) V _{in} = 200 vac(pk) [1] [2]	dv/dt(s)	400	—	—	V/μs	
Holding Current, Either Direction (I _F = 0, V _D = 12 V, I _T = 200 mA)	I _H	—	300	—	μA	

COUPLED

LED Trigger Current Required to Latch Output Either Direction (Main Terminal Voltage = 2.0 V) [3] [4]	MOC2A60-10 MOC2A60-5	I _{FT} (on)	—	7.0	10	mA
On-State Voltage, Either Direction (I _F = Rated I _{FT} (on), I _{TM} = 2.0 A)		V _{TM}	—	0.96	1.3	V
Inhibit Voltage, Either Direction (I _F = Rated I _{FT} (on)) [5] (Main Terminal Voltage above which device will not Trigger)		V _{INH}	—	8.0	10	V
Commutating dv/dt (Rated V _{DRM} , I _T = 30 mA – 2.0 A(rms), T _A = –40 ± 100°C, f = 60 Hz) [2]		dv/dt (c)	5.0	—	—	V/μs
Common-mode Input-Output dv/dt [2]		dv/dt(cm)	—	40,000	—	V/μs
Input-Output Capacitance (V = 0, f = 1.0 MHz)		C _{ISO}	—	1.3	—	pF
Isolation Resistance (V _{L-O} = 500 V)		R _{ISO}	10 ⁹	10 ¹⁴	—	Ω

Notes:

- [1] Per EIA/NARM standard RS-443, with V_P = 200 V, which is the instantaneous peak of the maximum operating voltage.
- [2] Additional dv/dt information, including test methods, can be found in Motorola applications note AN1048/D, Figure 43.
- [3] All devices are guaranteed to trigger at an I_F value less than or equal to the max I_{FT}. Therefore, the recommended operating I_F lies between the device's maximum I_{FT}(on) limit and the Maximum Rating of 50 mA.
- [4] Current-limiting resistor required in series with LED.
- [5] Also known as "Zero Voltage Turn-On".

6

TYPICAL CHARACTERISTICS

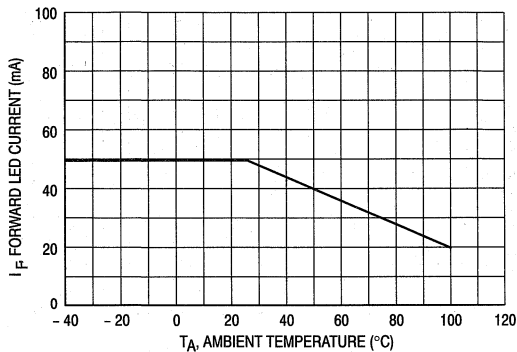

Figure 1. Maximum Allowable Forward LED Current versus Ambient Temperature

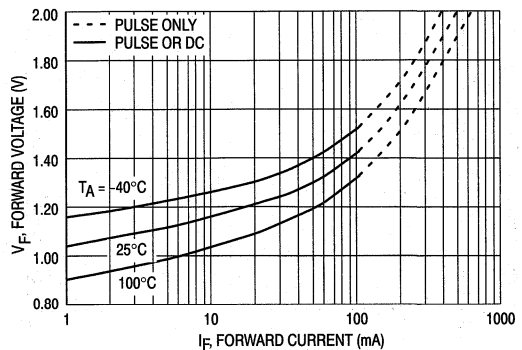

Figure 2. LED Forward Voltage versus LED Forward Current

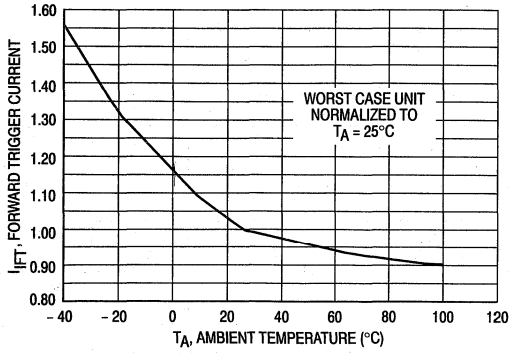

Figure 3. Forward LED Trigger Current versus Ambient Temperature

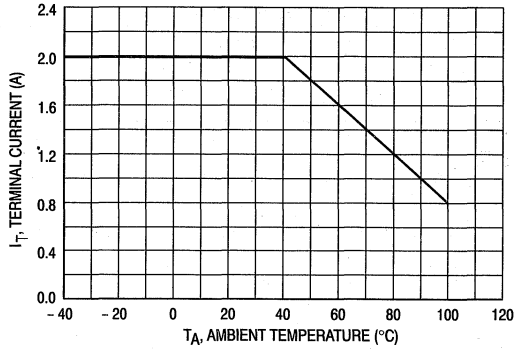

Figure 4. Maximum Allowable On-State RMS Output Current (Free Air) versus Ambient Temperature

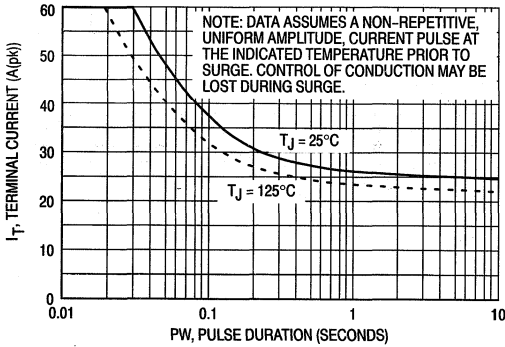

Figure 5. Maximum Allowable Surge Current versus Pulse Duration

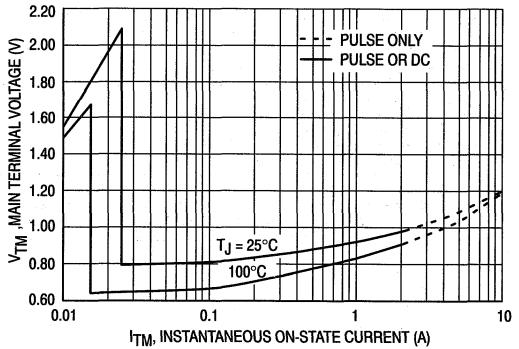

Figure 6. On-State Voltage Drop versus Output Terminal Current

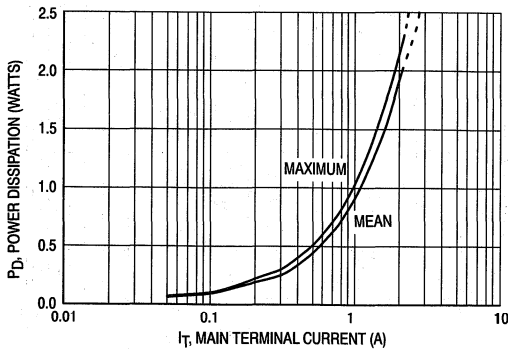

Figure 7. Power Dissipation versus Main Terminal Current

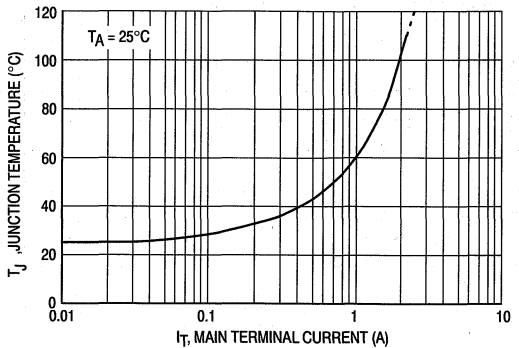

Figure 8. Junction Temperature versus Main Terminal RMS Current (Free Air)

6

MOC2A60-10 • MOC2A60-5

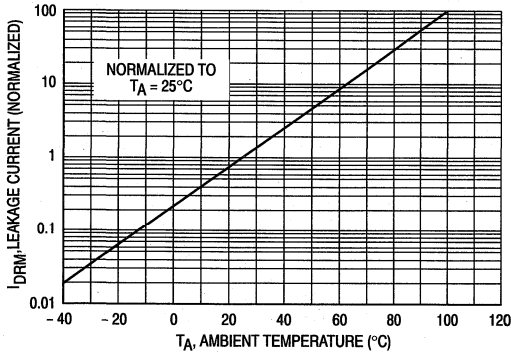

Figure 9. Leakage With LED Off versus Ambient Temperature

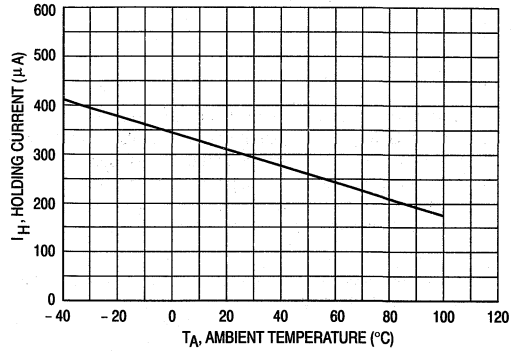

Figure 10. Holding Current versus Ambient Temperature

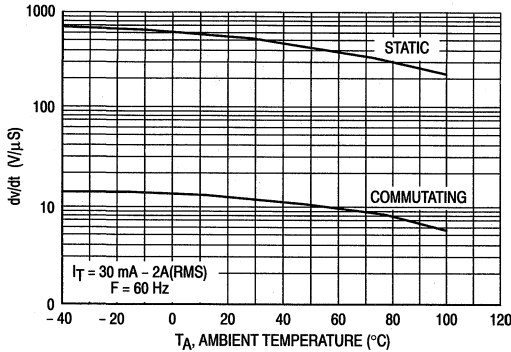

Figure 11. dv/dt versus Ambient Temperature

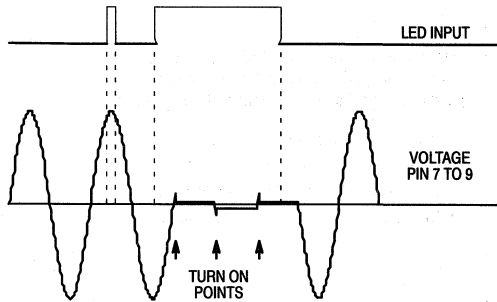

Figure 12. Operating Waveforms

6

*ZERO VOLTAGE ACTIVATE CIRCUIT

Select the value of R1 according to the following formulas:

- [1] $R1 = (VCC - VF) / \text{Max. } I_{FT} \text{ (on) per spec.}$
- [2] $R1 = (VCC - VF) / 0.050$

Typical values for C1 and R2 are 0.01 µF and 39 Ω, respectively. You may adjust these values for specific applications. The maximum recommended value of C1 is 0.022 µF. See application note AN1048 for additional information on component values.

The MOV may or may not be needed depending upon the characteristics of the applied ac line voltage. For applications where line spikes may exceed the 600 V rating of the MOC2A60, an MOV is required.

Figure 13. Typical Application Circuit

Use care to maintain the minimum spacings as shown. Safety and regulatory requirements dictate a minimum of 8.0 mm between the closest points between input and output conducting paths, Pins 3 and 7. Also, 0.070 inches distance is required between the two output Pins, 7 and 9.

Keep pad sizes on Pins 7 and 9 as large as possible for optimal performance.

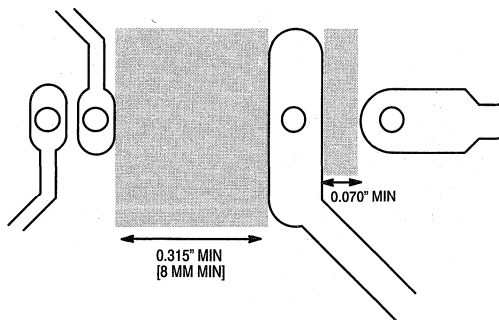

Figure 14. PC Board Layout Recommendations

Each device, when installed in the circuit shown in Figure 15, shall be capable of passing the following conducted noise tests:

- IEEE 472 (2.5 KV)
- Lamp Dimmer (NEMA Part DC33, § 3.4.2.1)
- NEMA ICS 2-230.45 Showering Arc
- MIL-STD-461A CS01, CS02 and CS06

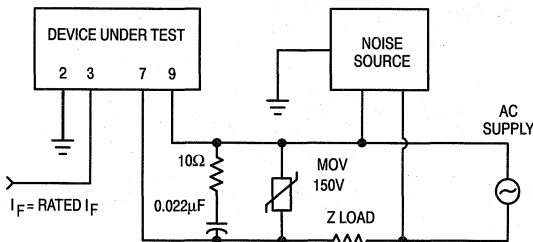
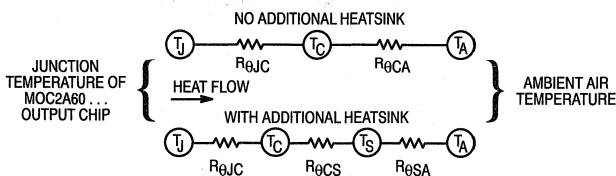

Figure 15. Test Circuit for Conducted Noise Tests



Terms in the model signify:

- T_A = Ambient temperature
- T_S = Optional additional heat sink temperature
- T_C = Case temperature
- T_J = Junction temperature
- P_D = Power dissipation
- $R_{\theta SA}$ = Thermal resistance, heat sink to ambient
- $R_{\theta CA}$ = Thermal resistance, case to ambient
- $R_{\theta CS}$ = Thermal resistance, heat sink to case
- $R_{\theta JC}$ = Thermal resistance, junction to case

Values for thermal resistance components are: $R_{\theta CA} = 36^\circ\text{C/W/in}$ maximum
 $R_{\theta JC} = 8.0^\circ\text{C/W}$ maximum

The design of any additional heatsink will determine the values of $R_{\theta SA}$ and $R_{\theta CS}$.

$$T_C - T_A = P_D (R_{\theta CA})$$

$$= P_D (R_{\theta JC} + R_{\theta SA}), \text{ where } P_D = \text{Power Dissipation in Watts.}$$

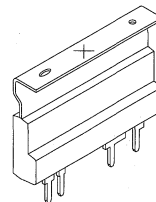

Thermal measurements of $R_{\theta JC}$ are referenced to the point on the heat tab indicated with an 'X'. Measurements should be taken with device orientated along its vertical axis.

Figure 16. Approximate Thermal Circuit Model

6

Applications of the MOC2A40 and MOC2A60 Series POWER OPTO™ ISOLATORS

Prepared by: Horst Gempe
Discrete Applications Engineering

INTRODUCTION

Electronic controls of AC power loads based on microprocessor controllers, digital or linear sensor circuits are increasing in popularity. Consequently, there is an increasing need for a simple and robust interface between the low voltage control circuitry and the AC line and loads. This interface must galvanically isolate the AC power line and its superimposed transients from the noise sensitive, low-voltage dc control circuits. It also must be simple to use, regulatory approved,

consume little PC board space and be able to switch the most common loads such as small motors, power relays, incandescent lights and resistive loads without generating excessive heat.

The MOC2A40 and MOC2A60 POWER OPTO Isolator families meet all the above requirements and offer an ideal system solution.

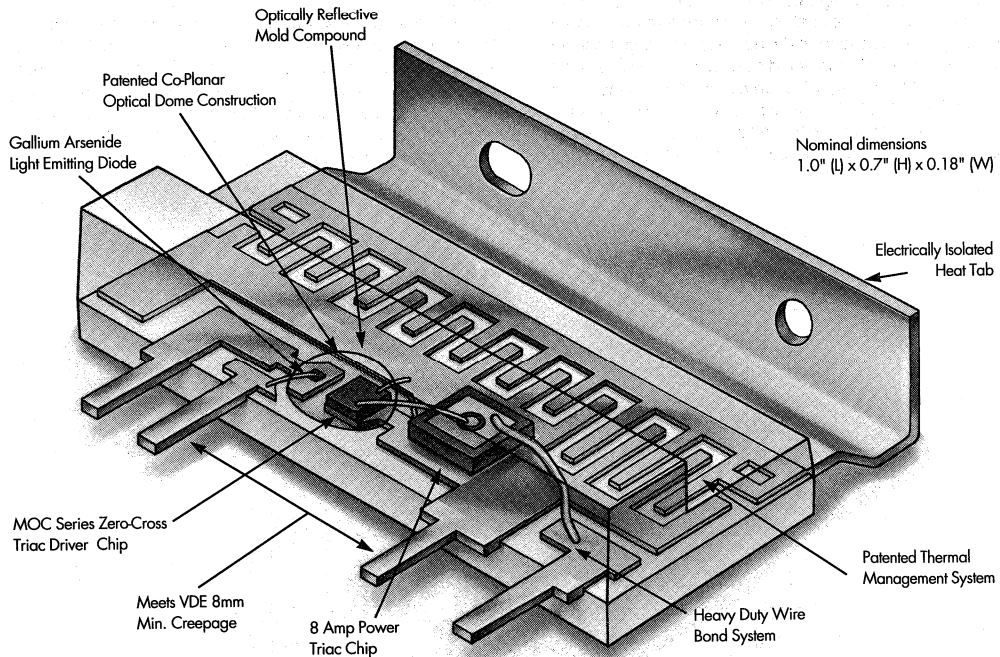

Figure 1. Internal Construction of the POWER OPTO Isolator

POWER OPTO is a trademark of Motorola, Inc.

PRODUCT DESCRIPTION

The Motorola AC POWER OPTO Isolator is a hybrid device containing three individual active semiconductor chips. Figure 1 shows the internal structure of this device. An infrared light emitting diode on the input side converts the input current signal of several milliamps into an infrared radiation of 940 nm. This is transferred through a transparent isolation barrier onto the photo sensitive area of an AC compatible detector which controls the gate of a power triac. This creates galvanic isolation between the dc input control circuit and the output AC line voltage potential. The light sensitive detector contains a AC zero voltage detector which allows turn on of the detector chip by the LED only when the AC line voltage is below the specified inhibit voltage of ± 10 V. This feature guarantees turn on of the load close to the AC line zero cross point and prevents excessive inrush surge currents for most loads. High inrush currents are still experienced for loads such as motor startup and inductors which saturate at turn-on. For this reason, a guaranteed inrush surge current capability of 60 A is provided. This extremely high surge capability can be attributed to the rugged 120 x 120 mil power triac chip which is mounted on a large internal copper heat spreader. A patented interdigitated interface between the internal heat spreader and the devices integral heat tab provides optimized heat transfer and meets the regulatory requirements for safe (reinforced) isolation. This regulatory requirement mandates an external 8.0 mm creepage and clearance between the input and output leads and the isolated heat tab of the device. A 0.4 mm thick isolation barrier which must be able to withstand a surge voltage of 3750 V_{RMS} is also mandated. The isolation barrier between dc input and the AC output leads is formed by the silicone optical dome. The isolation barrier for the integral

heat sink is formed by the package epoxy which isolates the interlaced internal heat spreader from the external heat tab. A heavy duty 15 mil aluminum wire bond on the output side of the power triac ensures high surge capability.

Equivalent Electrical Circuit Diagram

Figure 2 shows in detail the internal circuitry of the MOC2A40 and MOC2A60 POWER OPTO Isolator families. Details of the of the triac driver ICs internal circuitry is shown and discussed to explain the theory of operation for these devices.

LED D1 emits light which is received by the detector light sensitive integrated circuit which is commonly named triac driver. PNP transistor, Q1, and light sensitive NPN transistor, Q2, form a light sensitive SCR with a gate resistor R1. Diode, D2, and FET, Q3, form the inhibiting network. The leakage current of D2 transfers the main terminal voltage to the FET gate and Zener diode, D3, clamps this voltage to about 15 V to prevent gate oxide breakdown when the main terminal voltage rises with the line voltage. A voltage on the main terminals above the gate threshold voltage of Q3 switches FET Q3 on, which shorts the photo sensitive gate and inhibits it to latch on. Q1', Q2', Q3', R1', D2', D3' form the same circuit as described above.

The two circuits are connected inverse parallel and may be described as two inverse parallel light sensitive photo SCRs with zero cross voltage detectors. This circuit can be further simplified and described as an optically controlled small signal triac with an AC zero cross detection circuit. The triac driver controls the gate of the main triac. Resistor R2 limits the current through the triac driver.

6

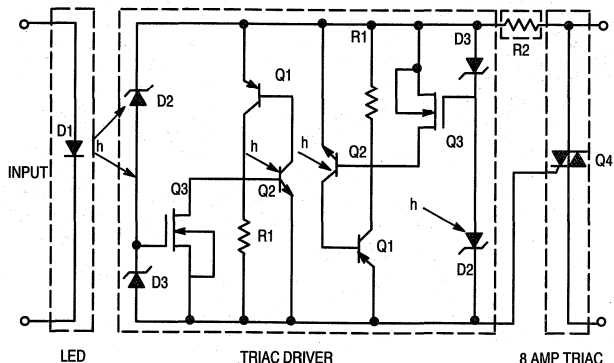

Figure 2. 2 Amp Optocoupler Circuit

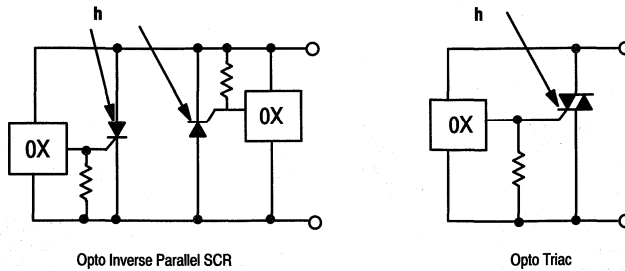

Figure 3. Triac Driver Simplified Circuits

OPERATION

An LED current of several mA will generate a photo current of several tens of micro amps in the collector base junctions of the NPN transistors of the triac driver chip. The SCR formed by the NPN-PNP transistor combination latches on when the photo generated current is present and the line voltage is below the inhibit voltage window, or in other words, within the zero cross window. Once the triac driver is latched on it allows sufficient current flow to the gate of the main triac which in turn latches on and carries the load current.

If the LED is turned on at a time when the line voltage exceeds the inhibit voltage, the driver is effectively disabled and will wait to latch on until the line voltage falls below the inhibit voltage. The driver and triac, however, are not able to switch on at absolute zero line voltage because they need a minimum voltage and current to be able to latch on. For example, if the LED is switched on when the line voltage is zero, the LED flux generates a photo current in the detector of several tens of micro amps, but the triac driver is not able to latch on until the line voltage rises to the driver's minimum main terminal voltage of about 1.0 V and a latching current of

several 100 μ A is present. A further increase in line voltage is necessary to trigger the main triac because its minimum gate voltage requirement in respect to MT1 voltage is also about 1.0 V and has to be added to the voltage drop across the triac driver. The main triac is able to turn on when at least 2.0 V are across its main terminals and enough gate current is generated to meet the triacs gate trigger current requirement. This is the earliest possible turn-on point within the zero-cross window. Conversely, the maximum inhibit voltage represents the last possible opportunity to turn on within the zero-cross window.

When the main triac is triggered, the voltage across its main terminals collapses to about 1.0 V. Figure 4 shows the zero voltage turn-on characteristic of a POWER OPTO Isolator as observed with an oscilloscope by monitoring the voltage across the main terminals of the device. Figure 5 shows a curve tracer plot which gives information about the voltage and current characteristic.

6

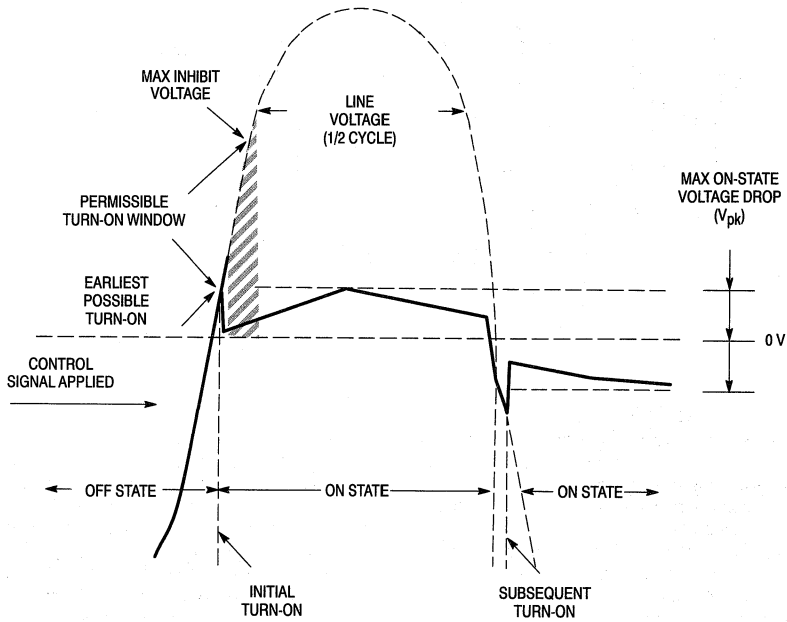

Figure 4. Zero-Voltage Turn-On Voltage Characteristics

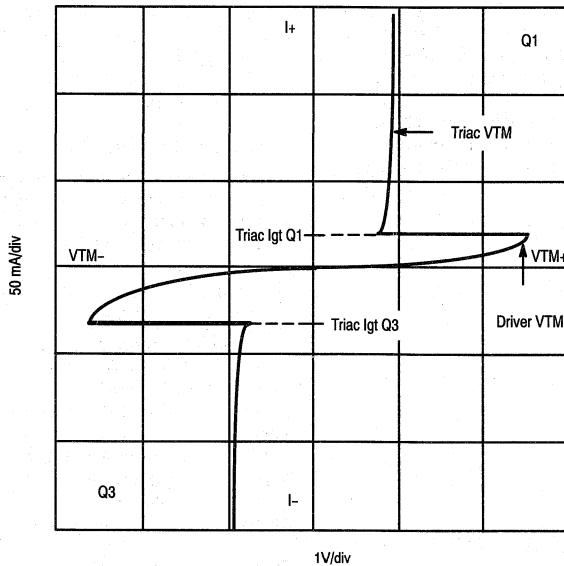

Figure 5. Curve Tracer Voltage versus Current Plot

After the power triac is turned on, the triac driver conducts only several hundred micro amps when the LED is still on but switches off and stays off when the LED current is removed. The main triac remains latched on until the load current falls below the triac's holding current. After this transition point, the driver will exclusively conduct the load current until the current falls below several 100 micro amps. At this point only the photo generated current of several tens of micro amps remains. Triac driver and main triac are switched off and are retrigged every half cycle until the LED is turned off. As the LED is switched off the triac driver is switched off, and the main triac falls out of conduction when the load current falls below the main triac's holding current (typically 20 mA).

The fact that the triac driver has an extremely low holding current allows the minimum load currents to be below the main triac trigger and holding current. In this triac driver only mode, the main triac never conducts and the load is only carried by the triac driver. In this low current triac driver only mode, commutating dv/dt is no longer a function of the main triac commutating capability, but is dependent on the triac driver's commutating dv/dt capability. This is only about 0.5 V/ μ s and should be considered marginal. Therefore, the use of a snubber is absolutely mandatory when switching loads in triac driver only mode is anticipated.

APPLICATIONS

Snubber Requirements

The application of the 2 amp POWER OPTO Isolators is very simple. Most loads ranging from 30 mA up to 2 A rms, including complex loads as discussed below, may be controlled without the use of a snubber network. Snubbers are required when the static and commutating dv/dt either generated by the load switched by the POWER OPTO Isolators or generated elsewhere on the AC line exceed the device's dv/dt ratings. In industrial environments where large inductive loads are switched on and off by contactors, transients may be generated which surpass the device's static dv/dt rating or the maximum V_{DRM} rating. For these cases a snubber consisting of a resistor and a capacitor will attenuate the rate of rise of the transient. A voltage clipping device (Metal Oxide Varistor MOV) which limits the amplitude of the transients should be used when the amplitude of the transients exceed the device's V_{DRM} ratings. Snubber and transient suppressors are connected across the main terminals of the POWER OPTO Isolator as shown in Figure 6.

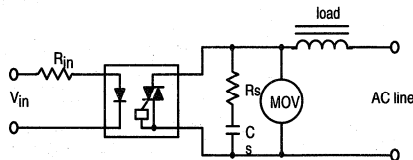

Figure 6. Application with Snubber and MOV

Typical values for the snubber capacitor C's and snubber resistor R's are 0.01 μF and 39 Ω respectively. These values may be adjusted for specific applications. See Application Note AN1048 for detailed information about snubber design considerations.

The placement of the load has no influence on the optocoupler's performance. It may be switched from the line neutral to the phase (hot) side or from the phase to neutral.

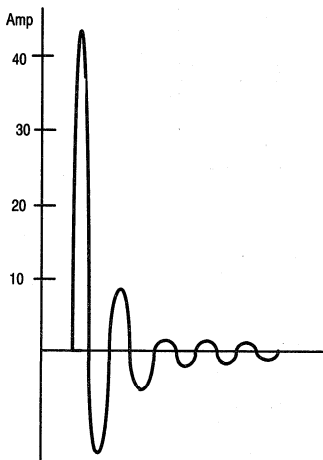

Figure 7. Size No. 4 Contactor Inrush Current

Input Current Requirement

It is very important to supply the data sheet specified input current to the device. Less input current may prevent turn-on of either both light sensitive SCRs or worse, be able to turn on only one SCR due to slight differences in I_{FT} for the positive and negative AC half wave. This situation causes half-waving of the load. Most inductive loads draw excessive current under this condition which may destroy either the load or the optocoupler. Low temperature operation requires increased input LED current as shown on the data sheet's I_{FT} vs. Temperature graph .

For example:

The I_{FT} for a MOC2A40-10 at 25°C is 10 mA, but is at -40°C 15.5 mA (I_{FT} @ 25°C*factor 1.55 as shown on the graph).

This minimum control current requirement dictates the value of the input current limiting resistor R_{in} for a given input voltage.

$$R_{in(max)} = \frac{V_{in} - V_{F(LED)}}{I_{FT(on)}}$$

$$R_{in(min)} = \frac{V_{in} - V_{FL(LED)}}{I_{Fmax}}$$

V_{in} = Input Voltage

V_{F(LED)} = voltage drop across LED = 1.3 V

I_{FT(on)} = specified LED trigger current * factor for low temperature operation

I_{F(max)} = maximum continues LED forward current (50mA)

Complex Loads

Surge Currents in Inductive Loads

Inductive loads may cause very high inrush surge currents because their magnetic core is forced into saturation as observed with transformers or the inductance is low at the initial startup which is typical for relays, solenoids and motors.

Example 1: Size No. 4 Contactor Control

The MOC2A40 has demonstrated its ability to handle large inrush currents by driving a size No. 4 contactor out to 2 million cycles without failure. The device is cycled one second on and one second off. The 115 V_{rms} input coil generates a 50 A peak in the first half cycle, and 20 A peak in the second half cycle as shown in Figure 7. The RMS steady state current is below 1 A. A MOC2A40 in free air is able to control this load without additional heat sinking and without the use of a snubber.

Two million device cycles without failure represent a reliability of M.T.B.F of >19.8 million device cycles.

Example 2: Transformer Inrush Current

It is mandatory in this application to make certain that the inrush current does not exceed the maximum 60 A specified surge current of the device. Residual core magnetization combined with zero cross turn-on may force the transformer into saturation with only the winding resistance left as effective load current limitation. For example, a 150 VA transformer with a 1.5 Ω winding resistance may draw in the first half-cycle up to 80 A of surge current. This excessive surge current can be avoided by using a NTC thermistor in series with the load as shown in Figure 8. A negative temperature coefficient thermistor has a relative high initial resistance when cold, which fast becomes lower due to self-heating in the steady-state operation.

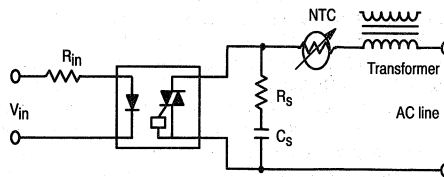

Figure 8. Thermistor Limits Excessive Inrush Current

Example 3: Surge Currents in Capacitive Loads

A rectifier bridge or a single diode in combination with a large capacitor in the micro Farad range represent a very low impedance at startup when the capacitor is being charged. When this type of load is switched on at the peak of the line

6

voltage, the inrush peak current is only limited by the wiring resistance and the ESR of the capacitor. However, the maximum inrush current I_p at zero voltage turn-on is limited by the AC line frequency and the peak line voltage and can be calculated as $I_p = C \cdot 2\pi \cdot f \cdot V_p$, where C is the capacitance in Farad, f the line frequency in Herz and V_p the peak line voltage. For an AC line voltage of 120 V_{rms} 60 Hz and a capacitor of 100 μ F, the surge current I_p is 6.4 A.

The above calculation for I_p applies to absolute zero voltage turn-on. Turn-on within the zero cross window voltage range of the POWER OPTO Isolators generates considerable higher inrush currents. A 100 μ F capacitor switched on at 5.0 V already produced an inrush current of 25 A. Accidental turn-on of the device at the peak of the line voltage charging a 100 μ F capacitor without current limitation leads to certain destruction of the power triac. Turn on outside the zero-cross window may be caused by line transients exceeding the devices VTM or dv/dt ratings. A inrush current limiting resistor or NTC Thermistor connected in series to the AC side of the rectifier and the POWER OPTO Isolators output can prevent this potential problem.

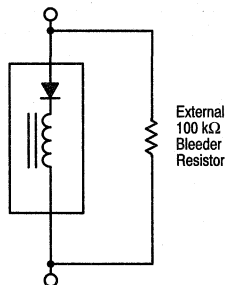

Figure 9. AC-DC Solenoid with Integral Diode

Example 4: AC-DC Solenoid with Internal Rectifier Diode

Some AC-DC relays and solenoids are made ac-dc compatible by using an internal rectifier diode in series with the coil. This poses a problem to a zero-crossing switch because the rectifier diode allows a dc build up across the input terminals. This DC forces the zero-cross switch into the inhibit mode which prevents the load from being switched on. A 100 K bleeder resistor across the input terminals of this type of load prevents dc build up thus allowing proper control. The wattage rating of this resistor is

$$P = \frac{V_{rms}^2}{R} \quad \text{where } P = 1/2 \text{ W for } 220 \text{ V}_{rms} \text{ and } 1/4 \text{ W for } 115 \text{ V}_{rms}$$

Example 5: Controlling an Inductive Load in a Rectifier Bridge

This configuration may cause triac switch off difficulties when the L/R time constant of the inductor to be switched is longer than 1/2 cycle of the line AC. In this case, the load current is not sinusoidal but constant, which causes the

current to be switched off rapidly as the line voltage changes polarity. The resulting high commutating di/dt may prevent the triac from turning off. The effect of this commutating dv/dt can be minimized by using a snubber across the device in combination with a commutating softening inductor L_s as shown in Figure 10. L_s is a small high permeability "square loop" inductor which can be constructed by using a ferrite toroid of 3/4" outside diameter with 33 turns of a number 18 gauge wire. Its core saturates when the load current is high but adds a high inductance when the load current falls below the holding current of the triac. This arrangement slows the rapid di/dt and delays the reapplication of the line voltage which improves the dv/dt capability of the triac.

Thermal Management

To insure proper and reliable operation of the isolated 2 A power switch, it is mandatory to operate the junction of the power triac within or below the maximum specified junction temperature. Temperatures above 125°C may lead to a possible loss of control (permanent latch on) and shortened life of the semiconductors. Junction over temperature problems can be avoided in the application when the devices thermal ratings are properly observed.

Free Standing Power Rating

The 2 Amp POWER OPTO Isolator device families are designed to be able to switch 2 A of AC rms and dissipate 2 W at an ambient free air temperature of up to 40°C without any additional heat sink. The single device rating only applies when free air circulation around the device – i.e. – natural air convection is allowed. There are major differences in effective air convection and the resulting temperature drop between the junction-to-air, depending on the amount and position of the devices on the PC board, and the PC board itself in respect to the natural air flow. Other power dissipating devices in close vicinity of the power switch will raise the ambient temperature which means less power can be dissipated by the switch. This also holds true for enclosures which inhibit or restrict the free air flow around the power switch and result in an increased ambient temperature. The maximum allowed power dissipation versus the increase of ambient temperature is shown in Figure 11. A horizontally positioned PC board with the device in its center will restrict natural air convection, while a vertical positioned PC board with the device positioned along the vertical axis will result in an optimized air convection. Free air flow around the epoxy body of the device and its heat sink creates a thermal air convection that cools the power semiconductor junction. Pin 7 conducts some of the generated heat to the PC board because it is part of the internal power semiconductor heat spreader. This heat transfer can be enhanced when one allows a large metalized area on the PC board at the vicinity of this pin for increased heat spreading.

Thermal Resistances of the Device

The heat of the power semiconductor junction is conducted to the internal heat spreader where it is then distributed to the epoxy body and the integral and electrically isolated heat tab of the device. Some of the heat in the heat spreader is transferred to the printed circuit board through main terminal pin 7.

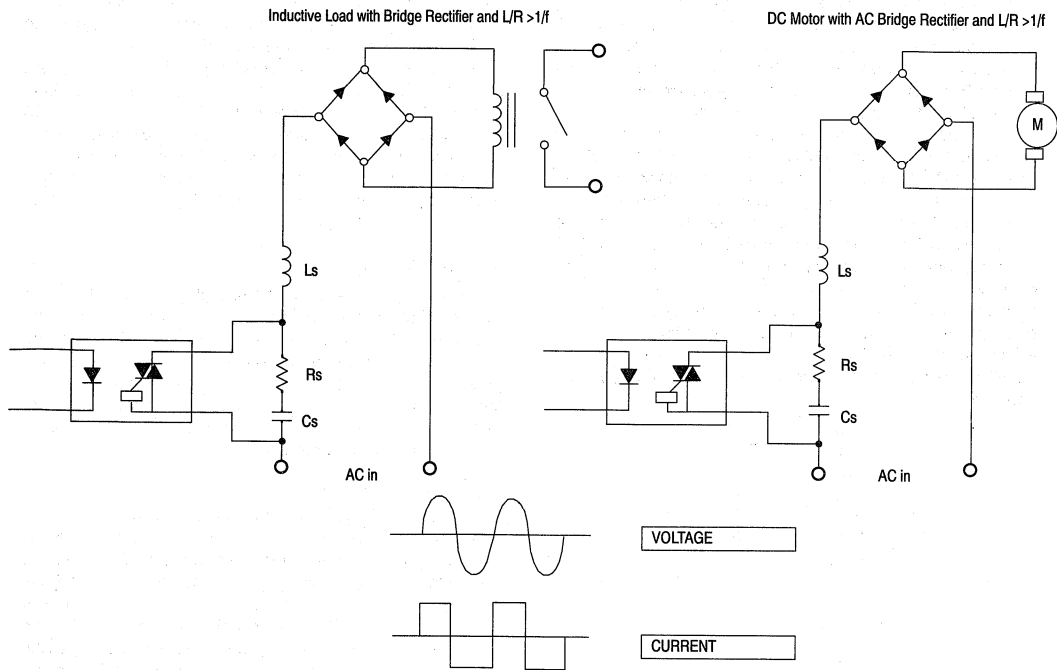

Figure 10. Inductive Loads with Bridge Rectifier

The epoxy body, integral heat sink and the PC board transfer this heat to the ambient air. Each heat path has its own thermal resistance. All these thermal resistances are in parallel and grouped together in the device's thermal rating of $R_{\theta JA}$ which is 40°C/W for a free-standing, single device mounted on a PC board.

Thermal resistances are as follows:

- $R_{\theta JA}$ Thermal resistance from junction to ambient
air = 40°C/W
- $R_{\theta JC}$ Thermal resistance junction to case
(epoxy body back side and heat tab) = 8°C/W
- $R_{\theta JT}$ Thermal resistance junction to heat tab only
 $\sim 14^{\circ}\text{C/W}$. (This is not specified in the data sheet)
- $R_{\theta J p7}$ Junction to pin 7 (thermocouple on pin 7)
 $\sim 10^{\circ}\text{C/W}$ (This is not specified in the data sheet).
- $R_{\theta SA}$ Thermal resistance of additional
heat sink to ambient.

The junction temperature for a free standing single device is calculated as follows:

$$T_J = (VTM \cdot I_{rms} \cdot R_{\theta JA}) + T_A.$$

Power dissipation equals $P = VTM \cdot I_{rms}$ which is approximately 1 W per Ampere RMS flowing through the main terminals of the device. For exact calculation use the data sheet VTM value for a given current.

The maximum power dissipation for a free standing device is

$$P_{(max)} = \frac{T_{J(max)} - T_A}{R_{\theta JA}}$$

For example, the maximum power dissipation for a free standing MOC2A40 at an ambient temperature of 70°C is

$$P_{(max)} = \frac{125^{\circ}\text{C} - 70^{\circ}\text{C}}{40^{\circ}\text{C/W}} = 1.375 \text{ W or } I_{(max)} \text{ is } 1.37 \text{ A.}$$

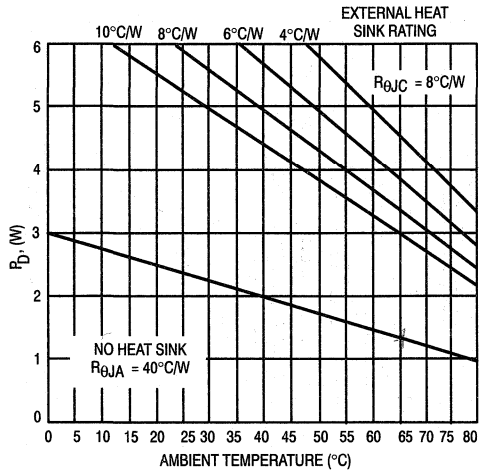

Figure 11. Power Derating versus Ambient Temperature

Material	Conductivity Watts In °C	Resistivity °C In/Watt
Air (100°C)	0.001	1,000
Aluminum	5.63	0.178
Alumina (Al Oxide)	0.55	1.82
Brass	2.97	0.337
Copper	9.93	0.101
Epoxy (Conductive)	0.02	50.0
Iron (Pure)	1.90	0.526
Nickel	1.52	0.658
Nickel Silver	0.84	1.19
Phosphor Bronze	1.80	0.555
Steel (1045)	1.27	0.787
Steel, Stainless (347)	0.41	2.44
Tin	1.60	0.625
Zinc	2.87	0.348

Figure 12. Thermal Resistance of Common Materials Used for Heat Sinking

Devices with Additional Heat Sink

All AC POWER OPTO Isolators contain an 8 A triac chip, but the maximum allowable switching current is limited by the heat dissipation of the package. Significant increase in switching current and the consequent power dissipation is possible by the use of an additional heat sink.

Since the integral sink and the epoxy body of these devices transfer heat, the best results are seen when the devices' entire back side is held in contact with the external heat sink, and thermal grease is used. This mounting method results in optimized heat conduction with the lowest practical possible thermal resistance of 8°C/W which is specified as RθJC. This includes the thermal resistance of the interface between the device and the heat sink.

Connecting the heat tab only to the external heat sink results in an thermal resistance RθJT of 14°C/W which includes the thermal interface resistance between the integral heat sink to the external heat sink.

The external heat sink can be of an extruded type which is commercially available, a flat aluminum plate or simply a part of a sheet metal frame or housing to which the device is held by a steel spring clip. External heat sinks are characterized by RθSA which is the thermal resistance from the heat sink to the ambient air. The lower the rating of the heat sink in terms of °C/W the better its thermal efficiency is. Figure 12 shows the thermal resistance of common heat sink materials. This thermal resistance must be added to the optocouplers thermal resistance RθJC or RθJT where applicable.

There are no electrical safety considerations because the device's heat sink is electrically isolated and regulatory approved.

It is possible to calculate the devices junction temperature T_J as follows, T_J = ((VTM*Irms*(RθJC + RθCA)) + T_A.

We are also able to calculate the maximum current and power dissipation allowed as follows,

$$P_{(max)} = \frac{T_J(max) - T_A}{R_{\theta JC} + R_{\theta CA}}$$

For example, a MOC2A40 device is mounted with its entire back side to a flat aluminum heat sink with a thermal rating RθSA of 5°C/W. Thermal grease is used on the interface and the ambient temperature is maximum 70°C.

$$P_{(max)} = \frac{125^{\circ}C - 70^{\circ}C}{8^{\circ}C/W + 5^{\circ}C/W} = 4.23 \text{ W}$$

The same external heat sink is used but only the device's heat tab is connected to aluminum heat sink which increases the thermal resistance from the semiconductor junction to the external heat sink. Note the considerable loss of power handling capability.

$$P_{(max)} = \frac{125^{\circ}C - 70^{\circ}C}{14^{\circ}C/W + 5^{\circ}C/W} = 2.89 \text{ W}$$

Figure 11 shows the maximum allowed power dissipation for a single free standing device without heat sink and for devices with various external heat sinks versus the ambient temperature.

6

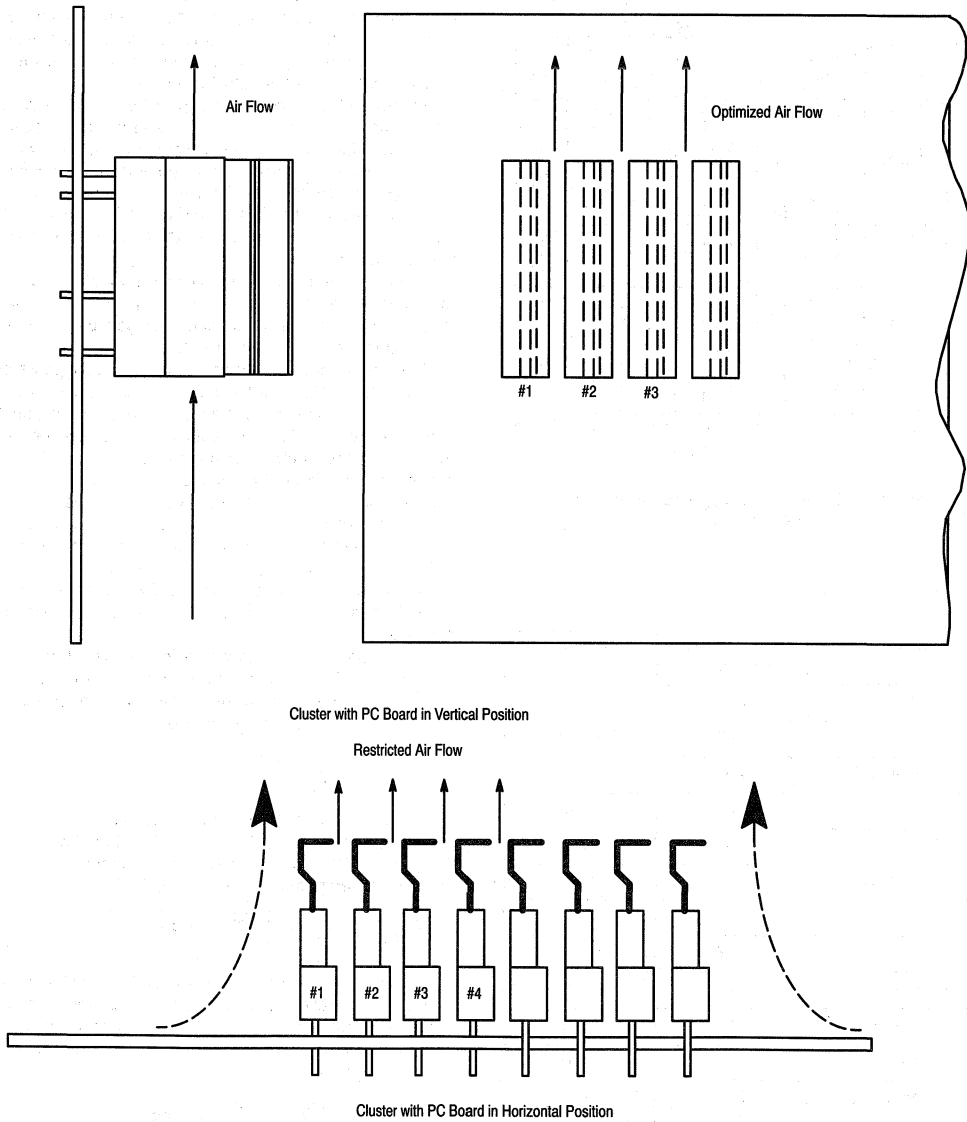

Figure 13. Clusters of Devices on a PC Board

Devices Stacked in Clusters with Minimal Spacing of 200 Mil

One of the great advantages of the 2A optocoupler family is its small footprint on a PC board. This enables the user to cluster many devices in one row with only 200 mil spacing from lead to lead as shown in Figure 13. Devices in this close approximation influence each other thermally by heat transfer through the epoxy bodies, the integral heat sinks and by heat conduction through pin 7 to the PC board. Prudence would suggest that clustered devices are running much hotter than a single free standing device and the maximum power handling must be derated when all devices within this cluster are switched on. It can be also predicted that devices in the center of the cluster run much hotter than the devices at each end. This also means the individual devices within the cluster are not able to dissipate the full rated power but must be thermally derated. The following study with clusters show the impact of this derating. Of course, the position of this cluster in respect to the natural air convection is also very important. Clusters on a horizontal positioned circuit board run much hotter than devices on a vertical oriented circuit board. Vertical orientation of the devices and the circuit board allow optimized heat flow due to the "chimney" effect. Figure 14 shows the heat distribution for each individual device in a cluster of 10 devices for vertical and horizontal circuit board positions. All devices are conducting 1 A of current which is about 1 W of power

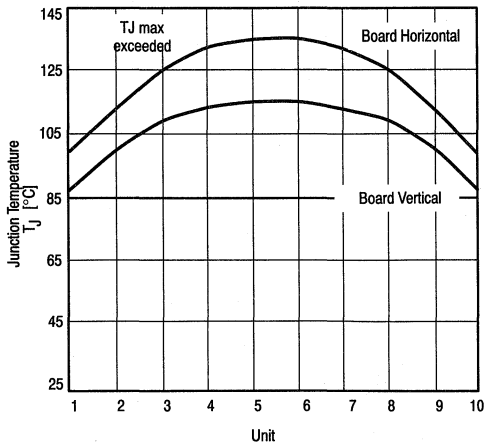

Figure 14. Cluster T_J Junction Temperature Distribution in a Cluster of 10 T_A = 25°C, All Devices on with I = 1 Arms

dissipation. As predicted, the devices in the center of the cluster show the highest temperature, while the devices at the end run cooler but are still much hotter than the stand alone rating would predict. The graph also demonstrates the importance of free air flow versus restricted air flow caused by a horizontal positioned PC board. It is important to note that the junction temperature of the center devices on the vertical positioned board exceeds the maximum rating of 125°C with a input power of only 1 watt! The dissipated power for these devices has to be lowered in order to stay within their maximum junction temperature rating.

It is now of interest to know the maximum power dissipation allowed for devices in various sized clusters or the maximum power allowed for devices within a large cluster versus the amount of devices switched on at the same time. The graph in Figure 15 is taken from a cluster of 25 devices where the X axis shows the number of units which are turned on with the same power dissipation and the Y axis shows the resulting maximum allowed power dissipation for each unit. The power is first applied to device#1 then to device#1 and device #2 then to device#1 and 2 and 3, and so on. The junction temperature of the hottest unit in the cluster (which is always in the center of the units turned on within the cluster) is the limiting factor. It is also interesting to note that the power derating is not a linear function of the cluster size but asymptotically levels out to a steady value for cluster sizes exceeding 20 devices.

6

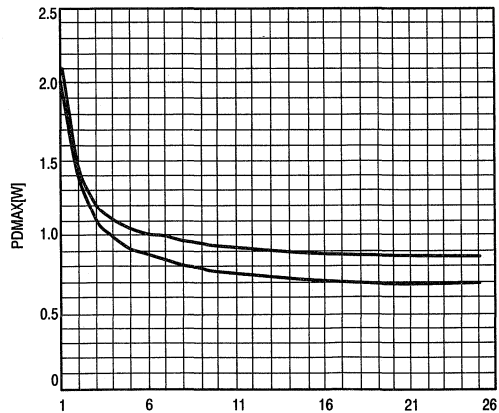
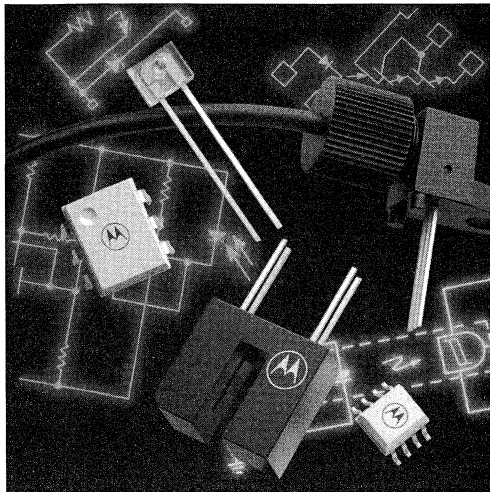

Figure 15. Maximum Allowed Power Dissipation per Device Versus Cluster Size

Section Seven



Discrete Emitters/Detectors

MLED81	7-2
MLED91	7-4
MLED96	7-7
MLED97	7-9
MLED930	7-11
MOC9000	7-13
MRD300	7-16
MRD360	7-19
MRD500	7-22
MRD821	7-25
MRD901	7-28
MRD911	7-30
MRD921	7-32
MRD950	7-35
MRD5009	7-39

Infrared LED

Features:

- Low Cost
- Popular T-1 $\frac{1}{4}$ Package
- Ideal Beam Angle for Most Remote Control Applications in Conjunction with MRD821
- Uses Stable Long-Life LED Technology
- Clear Epoxy Package

Applications:

Remote Controls and Long Distance Interruptive Sensing

MAXIMUM RATINGS

Rating	Symbol	Value	Unit
Reverse Voltage	V_R	5	Volts
Forward Current — Continuous	I_F	100	mA
Forward Current — Peak Pulse	I_F	1	A
Total Power Dissipation @ $T_A = 25^\circ\text{C}$ Derate above 25°C	P_D	100 2.2	mW mW/ $^\circ\text{C}$
Ambient Operating Temperature Range	T_A	-30 to +70	$^\circ\text{C}$
Storage Temperature	T_{stg}	-30 to +80	$^\circ\text{C}$
Lead Soldering Temperature, 5 seconds max, 1/16 inch from case	—	260	$^\circ\text{C}$

MLED81

Motorola Preferred Device

**INFRARED
LED
940 nm**



CASE 279B-01
STYLE 1



ELECTRICAL CHARACTERISTICS ($T_A = 25^\circ\text{C}$ unless otherwise noted)

Characteristic	Symbol	Min	Typ	Max	Unit
Reverse Leakage Current ($V_R = 3\text{ V}$)	I_R	—	10	—	nA
Reverse Leakage Current ($V_R = 5\text{ V}$)	I_R	—	1	10	μA
Forward Voltage ($I_F = 100\text{ mA}$)	V_F	—	1.35	1.7	V
Temperature Coefficient of Forward Voltage	ΔV_F	—	-1.6	—	mV/K
Capacitance ($f = 1\text{ MHz}$)	C	—	25	—	pF

OPTICAL CHARACTERISTICS ($T_A = 25^\circ\text{C}$ unless otherwise noted)

Characteristic	Symbol	Min	Typ	Max	Unit
Peak Wavelength ($I_F = 100\text{ mA}$)	λ_p	—	940	—	nm
Spectral Half-Power Bandwidth	$\Delta\lambda$	—	50	—	nm
Total Power Output ($I_F = 100\text{ mA}$)	Φ_e	—	16	—	mW
Temperature Coefficient of Total Power Output	$\Delta\Phi_e$	—	-0.25	—	%/K
Axial Radiant Intensity ($I_F = 100\text{ mA}$)	I_e	10	15	—	mW/sr
Temperature Coefficient of Axial Radiant Intensity	ΔI_e	—	-0.25	—	%/K
Power Half-Angle	ϕ	—	± 30	—	$^\circ$

MLED81

TYPICAL CHARACTERISTICS

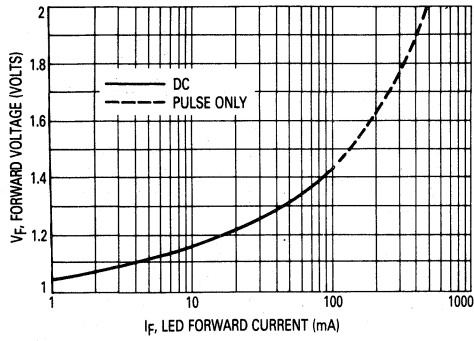

Figure 1. LED Forward Voltage versus Forward Current

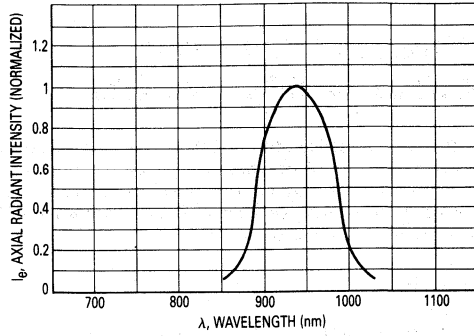

Figure 2. Relative Spectral Emission

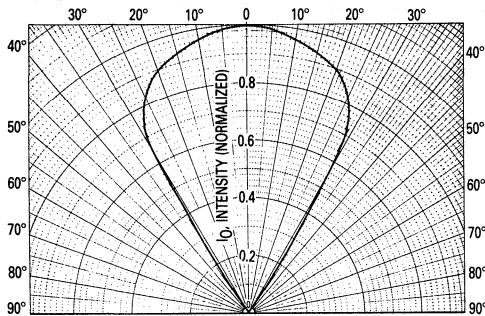

Figure 3. Spatial Radiation Pattern

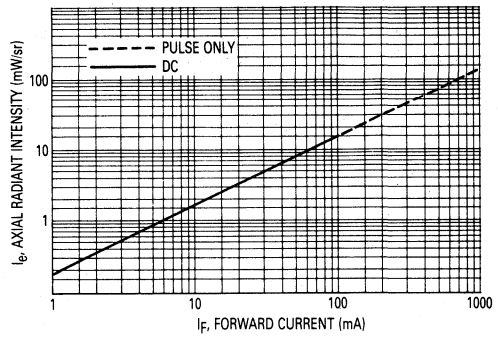

Figure 4. Intensity versus Forward Current

Advance Information
Infrared 940 nm LED

The MLED91 series 940 nm LEDs are multi-purpose devices capable for use in numerous applications. These Gallium Arsenide devices are manufactured to tight tolerances for maximum performance and long lifetime. The devices can be purchased in tape and reel format (in compliance with the EIA 468-A specification) to meet auto-insertion needs.

Features:

- Low Cost
- Well Suited for Use with Any MRD900 Series Optical Detector
- Low Degradation
- New Mold Technology Improves Performance Under Variable Environmental Conditions
- New Lens Design Offers Improved Optical Performance
- EIA 468-A Compliant Tape and Reel Option Available (MLED91RLRE and MLED91ARLRE)

Applications:

- Low Bit Rate Communication Systems
- Keyboards
- Coin Handlers
- Paper Handlers
- Touch Screens
- Shaft Encoders
- General Purpose Interruptive and Reflective Event Sensors

**MLED91
Series**

Motorola Preferred Devices

940 nm LED

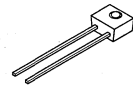

CASE 422A-01
Style 1

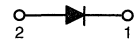

MAXIMUM RATINGS

Rating	Symbol	Value	Unit
Reverse Breakdown Voltage	V_R	6.0	Volts
Continuous Forward Current	I_F	100	mA
Peak Pulse Forward Current	I_F	1.0	A
Device Power Dissipation @ $T_A = 25^\circ\text{C}$ (1) Derate above 55°C	P_D	100 mW 2.0	mW mW/ $^\circ\text{C}$
Ambient Operating Temperature	T_{Op}	-40 to 100	$^\circ\text{C}$
Storage Temperature	T_{stg}	-40 to 100	$^\circ\text{C}$
Lead Soldering Temperature (2)	T_L	260	$^\circ\text{C}$

ELECTRICAL CHARACTERISTICS ($T_A = 25^\circ\text{C}$ unless otherwise noted)

Characteristic	Symbol	Min	Typ	Max	Unit
Reverse Leakage Current ($V_R = 6.0\text{ V}$)	I_R	—	0.05	100	μA
Forward Voltage ($I_F = 50\text{ mA}$)	V_F	—	1.3	1.5	Volts
Temperature Coefficient of Forward Voltage	ΔV_F	—	-1.6	—	mV/ $^\circ\text{C}$
Capacitance ($V = 0\text{ V}$, $f = 1.0\text{ MHz}$)	C	—	24	50	pF

(1) Measured with device soldered into a typical printed circuit board.

(2) Maximum exposure time: five seconds. Minimum of 1/16 inch from the case. A heat sink should be applied in order to prevent the case temperature from exceeding 100°C .

This document contains information on a new product. Specifications and information herein are subject to change without notice.

Preferred devices are Motorola recommended choices for future use and best overall value.

MLED91 Series

OPTICAL CHARACTERISTICS ($T_A = 25^\circ\text{C}$ unless otherwise noted)

Characteristic	Symbol	Min	Typ	Max	Unit
Peak Emission Wavelength ($I_F = 50\text{ mA}$)	λ	930	940	950	nm
Spectral Half Power Wavelength		—	48	—	nm
Spectral Output Temperature Shift		—	0.3	—	nm/ $^\circ\text{C}$
Axial Power Output Intensity ($I_F = 20\text{ mA}$) (3)	P_o	50	150	—	$\mu\text{W}/\text{sq cm}$
MLED91A		100	—	200	$\mu\text{W}/\text{sq cm}$
Intensity Per Unit Solid Angle ($I_F = 20\text{ mA}$) (3)	E_e	0.2	0.65	—	mW/Sr
MLED91A		0.4	—	0.9	mW/Sr
Power Half-Angle	Ω	—	± 20	—	$^\circ$
Rise Time and Fall Time	t_r, t_f	—	1.0	—	μs

(3) Measured using a 11.28 mm diameter detector placed 21 mm away from the device under test.

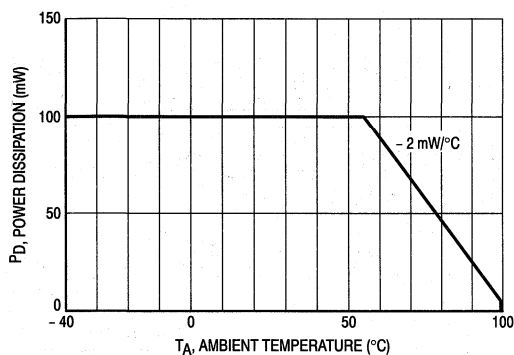

Figure 1. Power Dissipation

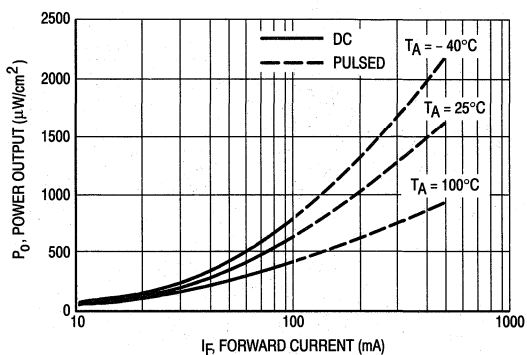

Figure 2. Power Output versus Forward Current
See Note 3 for Conditions.

7

MLED91 Series

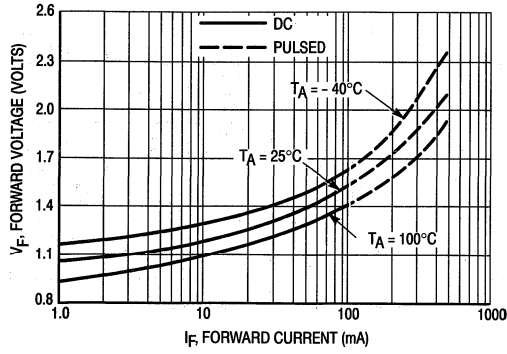

Figure 3. Forward Voltage versus Forward Current

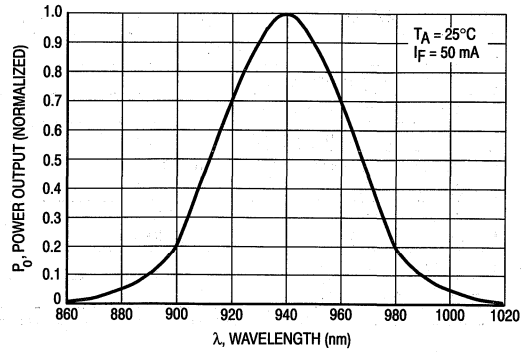

Figure 4. Relative Spectral Power Output

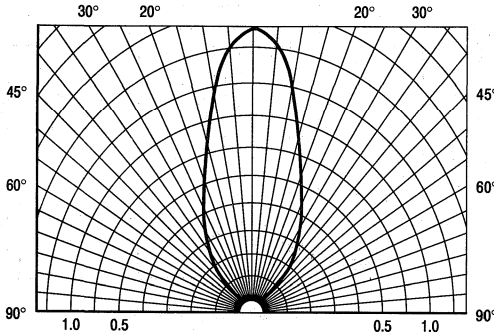

Figure 5. Spatial Radiation Pattern

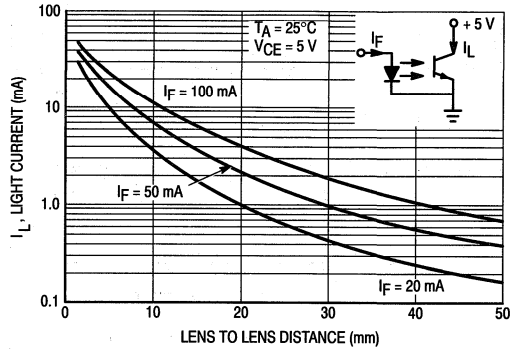

Figure 6. Coupled Characteristics of MLED91 and MRD901

7

MOTOROLA SEMICONDUCTOR TECHNICAL DATA

Advance Information 660 nm (RED) Light Emitting Diodes

Features:

- AlGaAs Technology Utilizing Low Degradation Processing
- Great for Use as an Indicator
- Well Suited for Use in Plastic Optical Fiber (POF) Applications
- EIA-468-A Compliant Tape and Reel Available (MLED96RLRE)

Applications:

- Plastic Optical Fiber (POF) Transmitters
- Visible Red LED Indicators

MAXIMUM RATINGS

Rating	Symbol	Value	Unit
Reverse Voltage	V_R	5.0	Volts
Forward Current — Continuous	I_F	60	mA
Forward Current — Peak Pulse	I_F	1.0	A
Total Power Dissipation @ $T_A = 25^\circ\text{C}$ (1) Derate above 35°C	P_D	100 2.0	mW mW/ $^\circ\text{C}$
Ambient Operating Temperature Range	T_A	-40 to +100	$^\circ\text{C}$
Storage Temperature	T_{stg}	-40 to +100	$^\circ\text{C}$
Lead Soldering Temperature (2)	T_L	260	$^\circ\text{C}$

ELECTRICAL CHARACTERISTICS ($T_A = 25^\circ\text{C}$ unless otherwise noted)

Characteristic	Symbol	Min	Typ	Max	Unit
Reverse Leakage Current ($V_R = 3.0\text{ V}$)	I_R	—	100	—	nA
Reverse Leakage Current ($V_R = 5.0\text{ V}$)	I_R	—	10	100	μA
Forward Voltage ($I_F = 60\text{ mA}$)	V_F	—	1.8	2.2	Volts
Temperature Coefficient of Forward Voltage	ΔV_F	—	-2.2	—	mV/K
Capacitance ($f = 1.0\text{ MHz}$)	C	—	50	—	pF

OPTICAL CHARACTERISTICS ($T_A = 25^\circ\text{C}$ unless otherwise noted)

Characteristic	Symbol	Min	Typ	Max	Unit
Peak Wavelength ($I_F = 60\text{ mA}$)	λ_p	—	660	—	nm
Spectral Half-Power Bandwidth	$\Delta\lambda$	—	20	—	nm
Axial Power Output Intensity ($I_F = 100\text{ mA}$) (3)	P_o	80	220	—	$\mu\text{W}/\text{sq cm}$
Instantaneous Axial Intensity ($I_F = 100\text{ mA}$) (4)	I_o	0.8	1.3	—	mW/sr
Power Half-Angle	θ	—	± 20	—	$^\circ$
Optical Turn-On Time	t_{on}	—	200	—	ns
Optical Turn-Off Time	t_{off}	—	150	—	ns
Half-Power Electrical Bandwidth (5)	BWe	—	6.0	—	MHz

(1) Measured with device soldered into a typical printed circuit board.

(2) 5 seconds max; 1/16 inch from case. Heat sink should be applied during soldering, to prevent case temperature from exceeding 100°C .

(3) Measured using a 11.28 mm diameter detector placed 21.0 mm away from the device under test.

(4) On-axis, with cone angle of $\pm 13^\circ$.

(5) $I_F = 100\text{ mA}$ pk-pk, 100% modulation.

This document contains information on a new product. Specifications and information herein are subject to change without notice.

Preferred devices are Motorola recommended choices for future use and best overall value.

MLED96

Motorola Preferred Device

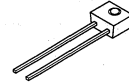

CASE 422A-01
STYLE 4

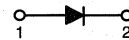

TYPICAL CHARACTERISTICS

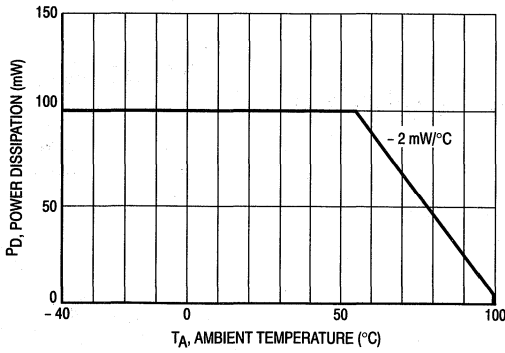

Figure 1. Power Dissipation

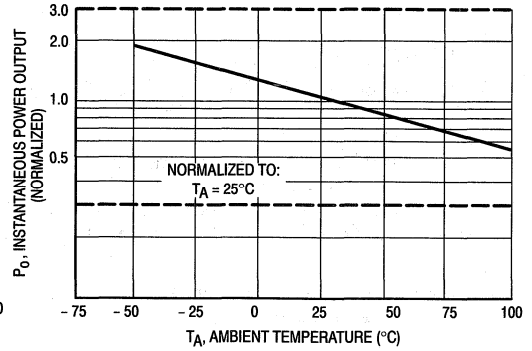

Figure 2. Instantaneous Power Output versus Ambient Temperature

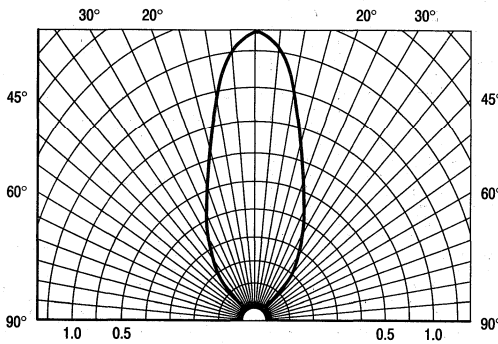

Figure 5. Spatial Radiation Pattern

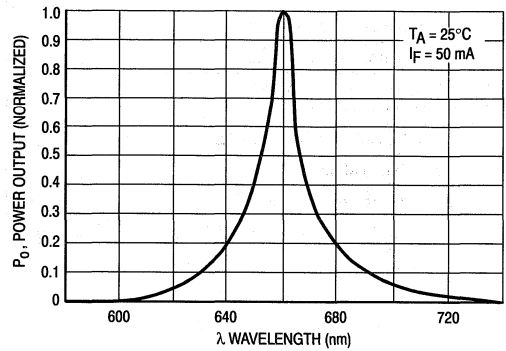

Figure 4. Relative Spectral Emission

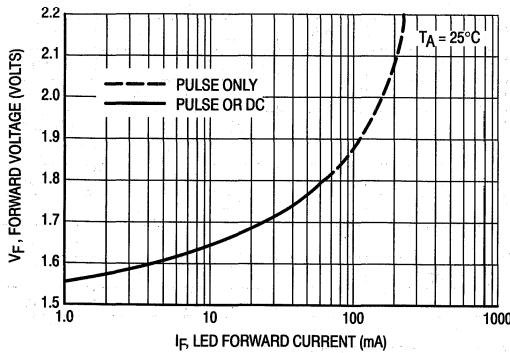

Figure 5. Forward Voltage versus Forward Current

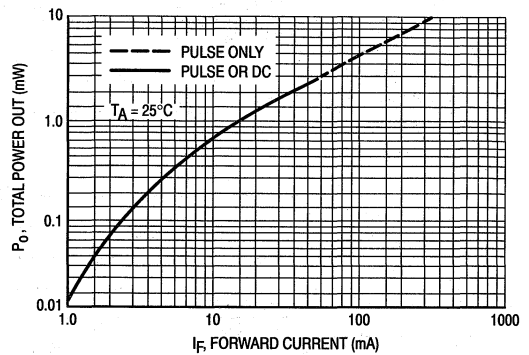

Figure 6. Instantaneous Power Output versus Forward Current

Advance Information
850nm Light Emitting Diode

MLED97

Motorola Preferred Device

Features:

- Low Degradation AlGaAs Processing
- High Power
- Well-Matched to Si Detectors
- Plastic Optical Fiber (POF) Transmission Matched

Applications:

- Plastic Optical Fiber Transmitters
- Silicon Sensors Requiring Close Wavelength Matching

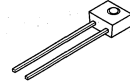

CASE 422A-01
STYLE 4

MAXIMUM RATINGS

Rating	Symbol	Value	Unit
Reverse Voltage	V_R	6.0	Volts
Forward Current — Continuous	I_F	60	mA
Forward Current — Peak Pulse	I_F	1.0	A
Total Power Dissipation @ $T_A = 25^\circ\text{C}$ (1) Derate above 40°C	P_D	120 2.0	mW mW/ $^\circ\text{C}$
Ambient Operating Temperature Range	T_A	- 40 to +100	$^\circ\text{C}$
Storage Temperature	T_{stg}	- 40 to +100	$^\circ\text{C}$
Lead Soldering Temperature (2)	T_L	260	$^\circ\text{C}$

ELECTRICAL CHARACTERISTICS ($T_A = 25^\circ\text{C}$ unless otherwise noted)

Characteristic	Symbol	Min	Typ	Max	Unit
Reverse Leakage Current ($V_R = 6.0\text{ V}$)	I_R	—	0.05	100	μA
Forward Voltage ($I_F = 50\text{ mA}$)	V_F	—	1.4	2.0	Volts
Temperature Coefficient of Forward Voltage	ΔV_F	—	-1.6	—	mV/K
Capacitance ($V = 0\text{ V}$, $f = 1.0\text{ MHz}$)	C	—	200	—	pF

OPTICAL CHARACTERISTICS ($T_A = 25^\circ\text{C}$ unless otherwise noted)

Characteristic	Symbol	Min	Typ	Max	Unit
Peak Wavelength ($I_F = 60\text{ mA}$)	λ_p	—	850	—	nm
Spectral Half-Power Bandwidth	$\Delta\lambda$	—	40	—	nm
Axial Power Output Intensity ($I_F = 100\text{ mA}$)	P_O	200	—	—	$\mu\text{W}/\text{sq cm}$
Power Half-Angle	θ	—	± 30	—	$^\circ$
Optical Rise and Fall Time (10% – 90%) (See Figure 7)	t_r, t_f	—	25	35	ns

(1) Measured with device soldered into a typical printed circuit board.

(2) 5 seconds max; 1/16 inch from case. Heat sink should be applied during soldering, to prevent case temperature from exceeding 100°C .

This document contains information on a new product. Specifications and information herein are subject to change without notice.
Preferred devices are Motorola recommended choices for future use and best overall value.

7

TYPICAL CHARACTERISTICS

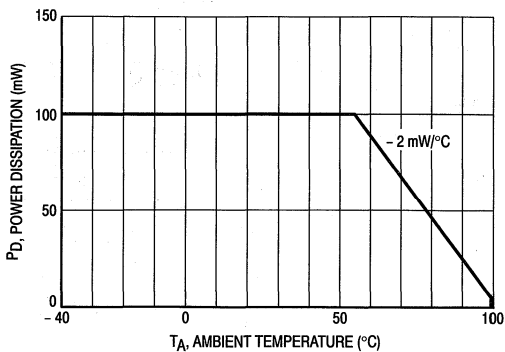

Figure 1. Power Dissipation

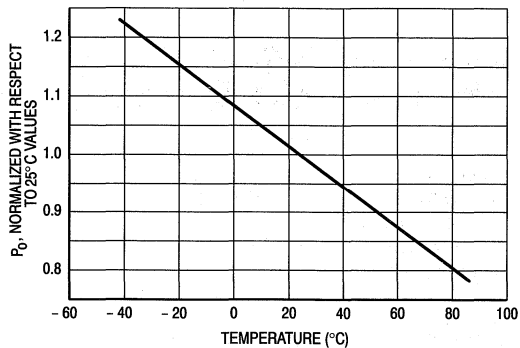

Figure 2. Instantaneous Power Output Ambient Temperature

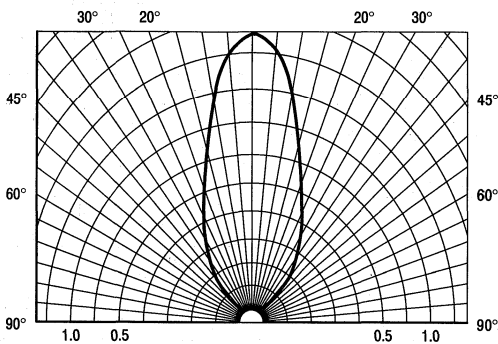

Figure 5. Spatial Radiation Pattern

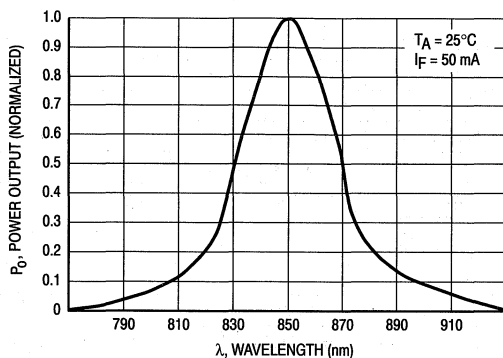

Figure 4. Relative Spectral Output

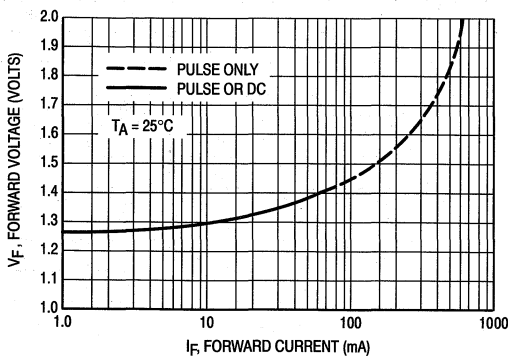

Figure 5. Forward Voltage versus Forward Current

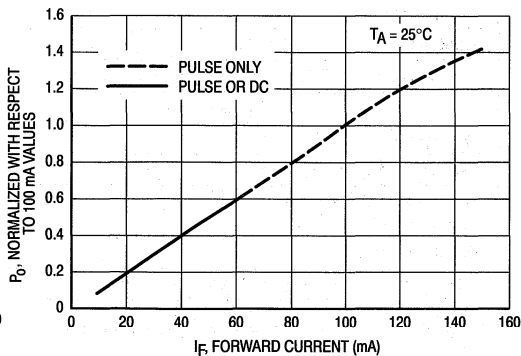

Figure 6. Instantaneous Power Output versus Forward Current

7

Infrared LED (940 nm)

The MLED930 is designed for applications requiring high power output, low drive power and very fast response time. It is spectrally matched for use with silicon detectors.

Features:

- High-Power Output — 4 mW (Typical) @ $I_F = 100$ mA, Pulsed
- Infrared-Emission — 940 nm (Typical)
- Low Drive Current — 10 mA for 450 μ W (Typical)
- Popular TO-18 Type Package for Easy Handling and Mounting
- Hermetic Metal Package for Stability and Reliability

Applications:

- Industrial Processing and Control
- Shaft or Position Readers
- Optical Switching
- Remote Control
- Light Modulators
- Punched Card Readers
- Logic Circuits

MLED930

Motorola Preferred Device

**INFRARED
LED
940 nm**

CONVEX
LENS

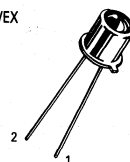

**CASE 209-01
METAL
STYLE 1**

MAXIMUM RATINGS

Rating	Symbol	Value	Unit
Reverse Voltage	V_R	6	Volts
Forward Current — Continuous	I_F	60	mA
Forward Current — Peak Pulse (PW = 100 μ s, d.c. = 2%)	I_F	1	A
Total Device Dissipation @ $T_A = 25^\circ\text{C}$ Derate above 25°C (Note 1)	P_D	250 2.27	mW mW/ $^\circ\text{C}$
Operating Temperature Range	T_A	-55 to +125	$^\circ\text{C}$
Storage Temperature Range	T_{stg}	-65 to +150	$^\circ\text{C}$

ELECTRICAL CHARACTERISTICS ($T_A = 25^\circ\text{C}$ unless otherwise noted)

Characteristic	Fig. No.	Symbol	Min	Typ	Max	Unit
Reverse Leakage Current ($V_R = 3$ V)	—	I_R	—	2	—	nA
Reverse Breakdown Voltage ($I_R = 100$ μ A)	—	$V_{(BR)R}$	6	20	—	Volts
Forward Voltage ($I_F = 50$ mA)	2	V_F	—	1.32	1.5	Volts
Total Capacitance ($V_R = 0$ V, $f = 1$ MHz)	—	C_T	—	18	—	pF

OPTICAL CHARACTERISTICS ($T_A = 25^\circ\text{C}$ unless otherwise noted)

Characteristic	Fig. No.	Symbol	Min	Typ	Max	Unit
Total Power Output (Note 2) ($I_F = 60$ mA, dc) ($I_F = 100$ mA, PW = 100 μ s, duty cycle = 2%)	3, 4	P_O	— 1	2.5 4	—	mW
Radiant Intensity (Note 3) ($I_F = 100$ mA, PW = 100 μ s, duty cycle = 2%)	—	I_o	—	1.5	—	mW/ steradian
Peak Emission Wavelength	1	λ_P	—	940	—	nm
Spectral Line Half Width	1	$\Delta\lambda$	—	40	—	nm

Notes: 1. Printed Circuit Board Mounting

2. Power Output, P_O , is the total power radiated by the device into a solid angle of 2π steradians. It is measured by directing all radiation leaving the device, within this solid angle, onto a calibrated silicon solar cell.

3. Irradiance from a Light Emitting Diode (LED) can be calculated by:

$$H = \frac{I_o}{d^2}$$

where H is irradiance in mW/cm²; I_o is radiant intensity in mW/steradian;
 d^2 is distance from LED to the detector in cm.

MLED930

TYPICAL CHARACTERISTICS

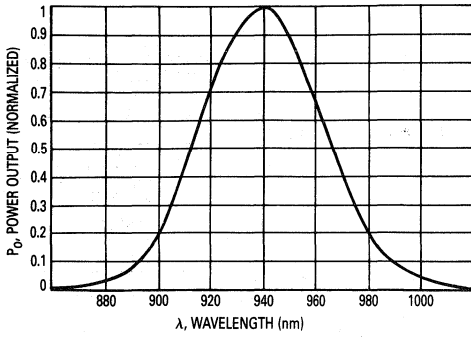

Figure 1. Relative Spectral Output

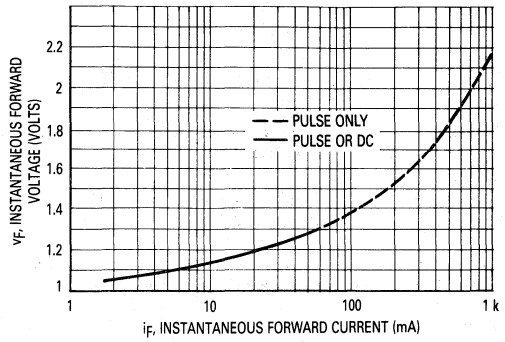

Figure 2. Forward Characteristics

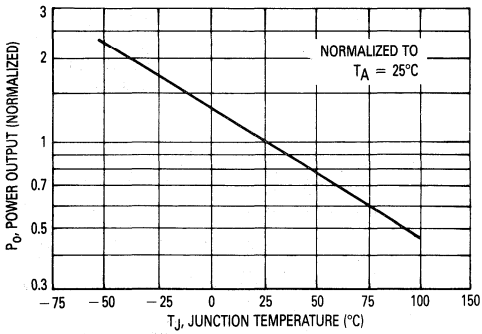

Figure 3. Power Output versus Junction Temperature

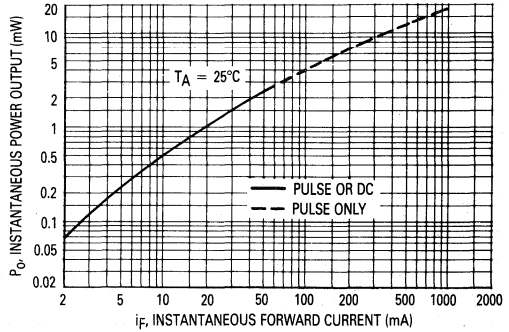

Figure 4. Instantaneous Power Output versus Forward Current

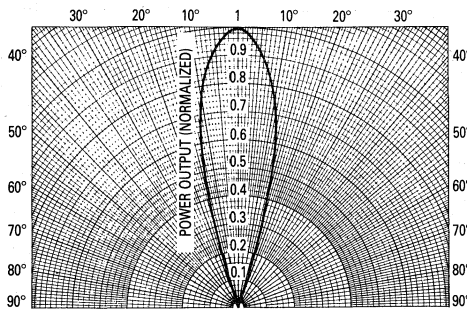

Figure 5. Spatial Radiation Pattern

7

Advance Information
**OPTO Transceiver and
Reflective Sensor**

Features:

- Low Degradation IR LED and NPN Phototransistor
- Low Cost
- New Mold Technology Improves Performance Under Variable Environmental Conditions
- New Lens Design Offers Improved Optical Performance
- EIA 468-A Compliant Tape and Reel Option Available (MOC9000RLRE)

Applications:

- Low Bit Rate, Short Distance Communication Systems
- Reflective Sensors
- Non-Contact Sensing and Communications

MOC9000

Motorola Preferred Device

**OPTO TRANSCEIVER AND
REFLECTIVE SENSOR**

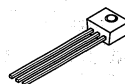

**CASE 422-01
Style 4**

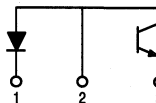

MAXIMUM RATINGS

Rating	Symbol	Value	Unit
Reverse Breakdown Voltage (LED)	V_R	6.0	Volts
Continuous Forward Current (LED)	I_F	50	mA
Peak Pulse Forward Current (LED)	I_F	1.0	A
Collector-Emitter Voltage (Transistor)	V_{CEO}	30	Volts
Device Power Dissipation @ $T_A = 25^\circ\text{C}$ (1) Derate above 55°C	P_D	100 mW 2.0	mW mW/ $^\circ\text{C}$
Ambient Operating Temperature	T_{op}	-40 to 100	$^\circ\text{C}$
Storage Temperature	T_{stg}	-40 to 100	$^\circ\text{C}$
Lead Soldering Temperature (2)	T_L	260	$^\circ\text{C}$

LED ELECTRICAL CHARACTERISTICS ($T_A = 25^\circ\text{C}$ unless otherwise noted)

Characteristic	Symbol	Min	Typ	Max	Unit
Reverse Leakage Current ($V_R = 6.0\text{ V}$)	I_R	—	0.05	100	μA
Forward Voltage ($I_F = 50\text{ mA}$)	V_F	—	1.3	1.5	Volts
Temperature Coefficient of Forward Voltage	ΔV_F	—	-1.6	—	mV/ $^\circ\text{C}$
Capacitance ($V = 0\text{ V}$, $f = 1.0\text{ MHz}$)	C	—	24	50	pF

(1) Measured with device soldered into a typical printed circuit board.

(2) Maximum exposure time: five seconds. Minimum of 1/16 inch from the case. A heat sink should be applied in order to prevent the case temperature from exceeding 100°C .

This document contains information on a new product. Specifications and information herein are subject to change without notice.
Preferred devices are Motorola recommended choices for future use and best overall value.

LED OPTICAL CHARACTERISTICS (T_A = 25°C unless otherwise noted)

Characteristic	Symbol	Min	Typ	Max	Unit
Peak Emission Wavelength (I _F = 50 mA)	λ	930	940	950	nm
Spectral Half Power Wavelength	—	—	48	—	nm
Spectral Output Temperature Shift	—	—	0.3	—	nm/°C
Axial Power Output Intensity (I _F = 20 mA) ⁽³⁾	P _O	25	50	—	μW/sq cm
Intensity Per Unit Solid Angle (I _F = 20 mA) ⁽³⁾	E _o	0.2	0.65	—	mW/Sr
Power Half-Angle	Ω	—	±30	—	°
Rise Time and Fall Time	t _r , t _f	—	1.0	—	μS

ELECTRICAL CHARACTERISTICS (T_A = 25°C unless otherwise noted)

Characteristic	Symbol	Min	Typ	Max	Unit
Collector Dark Current (V _{CE} = 10 V, H = 0 (Dark))	I _D	—	10	100	nA
Collector Emitter Breakdown Voltage (I _C = 100 μA)	BV _{CEO}	30	—	—	Volts

OPTICAL CHARACTERISTICS (T_A = 25°C unless otherwise noted)

Characteristic	Symbol	Min	Typ	Max	Unit
Collector Light Current (V _{CE} = 5.0 V, H = 500 μW/sq cm @ 940 nm)	I _L	0.1 0.7	1.0 —	— 2.6	mA mA
Saturation Voltage (H = 3.0 mW/sq cm, Wavelength = 940 nm, I _C = 2.0 mA, V _{CE} = 5.0 V)	V _{CE(sat)}	—	—	0.4	Volts

(3) Measured using a 11.28 mm diameter detector placed 21 mm away from the device under test.

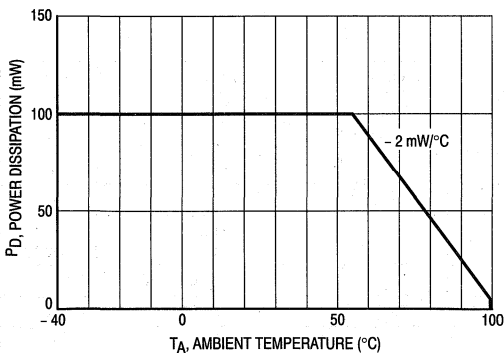

Figure 1. Power Dissipation

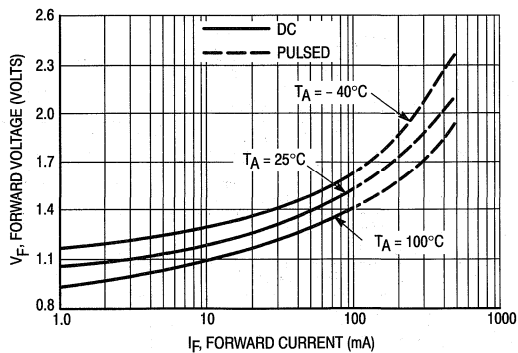

Figure 2. LED Forward Voltage versus Forward Current

7

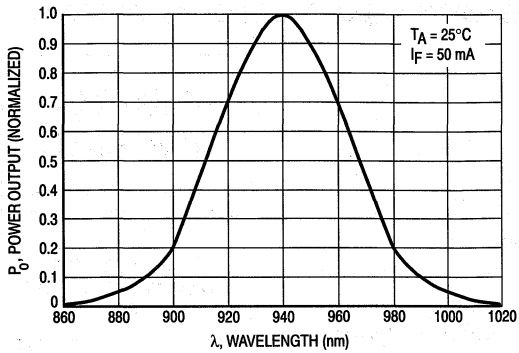

Figure 3. LED Relative Power Output versus Wavelength

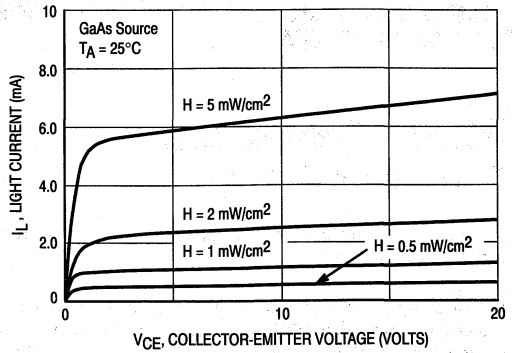

Figure 4. Transistor Collector Current versus Collector-Emitter Voltage

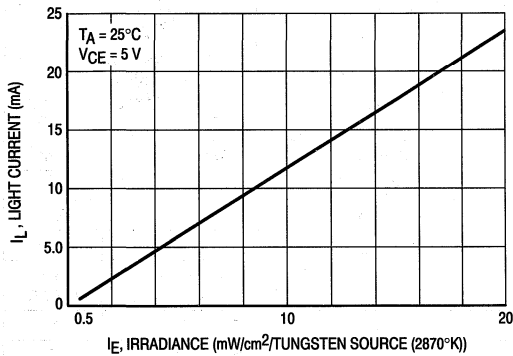

Figure 5. Transistor Collector Current versus Irradiance

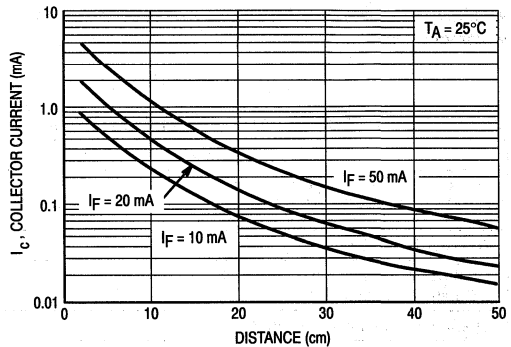

Figure 6. Current Transfer with Devices Optically Coupled

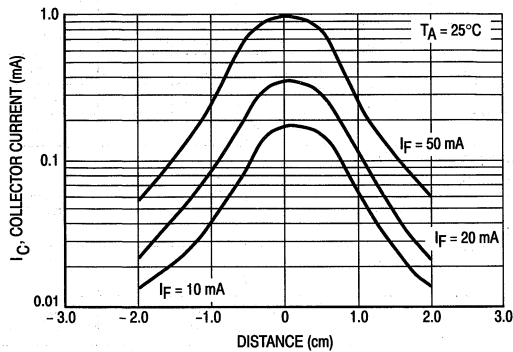

Figure 7. Translational Optical Coupling at 5 mm Separation (Lens to Lens)

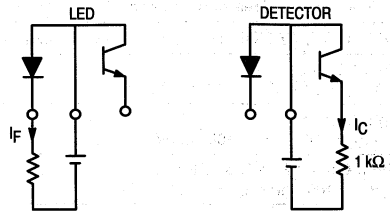

Figure 8. Test Circuit for Figures 6 and 7

Photo Detectors Transistor Output

The MRD300 and MRD310 are designed for applications requiring radiation sensitivity and stable characteristics.

Features:

- Popular TO-18 Type Package for Easy Handling and Mounting
- Sensitive Throughout Visible and Near Infrared Spectral Range for Wider Application
- Minimum Light Current 4 mA at $H = 5 \text{ mW/cm}^2$ (MRD300)
- External Base for Added Control
- Annular Passivated Structure for Stability and Reliability

Applications:

- Industrial Processing and Control
- Shaft or Position Readers
- Optical Switching
- Remote Control
- Light Modulators
- Punched Card Readers
- Logic Circuits
- Counters

MRD300
MRD310*

*Motorola Preferred Device

PHOTO DETECTORS
TRANSISTOR OUTPUT
NPN SILICON

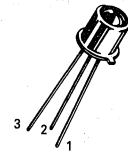

CASE 82-05
METAL
STYLE 1

MAXIMUM RATINGS ($T_A = 25^\circ\text{C}$ unless otherwise noted)

Rating	Symbol	Value	Unit
Collector-Emitter Voltage	V_{CEO}	50	Volts
Emitter-Collector Voltage	V_{ECO}	7	Volts
Collector-Base Voltage	V_{CBO}	80	Volts
Total Device Dissipation @ $T_A = 25^\circ\text{C}$ Derate above 25°C	P_D	250 2.27	mW mW/ $^\circ\text{C}$
Operating Temperature Range	T_A	-55 to +125	$^\circ\text{C}$
Storage Temperature Range	T_{stg}	-65 to +150	$^\circ\text{C}$

STATIC ELECTRICAL CHARACTERISTICS ($T_A = 25^\circ\text{C}$ unless otherwise noted)

Characteristic	Symbol	Min	Typ	Max	Unit
Collector Dark Current ($V_{CE} = 20 \text{ V}$, $H \approx 0$) $T_A = 25^\circ\text{C}$ $T_A = 100^\circ\text{C}$	I_{CEO}	—	5 4	25 —	nA μA
Collector-Base Breakdown Voltage ($I_C = 100 \mu\text{A}$)	$V_{(BR)CBO}$	80	120	—	Volts
Collector-Emitter Breakdown Voltage ($I_C = 100 \mu\text{A}$)	$V_{(BR)CEO}$	50	85	—	Volts
Emitter-Collector Breakdown Voltage ($I_E = 100 \mu\text{A}$)	$V_{(BR)ECO}$	7	8.5	—	Volts

OPTICAL CHARACTERISTICS ($T_A = 25^\circ\text{C}$ unless otherwise noted)

Light Current ($V_{CC} = 20 \text{ V}$, $R_L = 10 \text{ Ohms}$) Note 1	MRD300 MRD310	I_L	4 1	7 3.5	— —	mA
Light Current ($V_{CC} = 20 \text{ V}$, $R_L = 100 \text{ Ohms}$) Note 2	MRD300 MRD310	I_L	— —	2.5 0.8	— —	mA
Photo Current Rise Time (Note 3) ($R_L = 100 \text{ Ohms}$, $I_L = 1 \text{ mA peak}$)		t_r	—	2	2.5	μs
Photo Current Fall Time (Note 3) ($R_L = 100 \text{ Ohms}$, $I_L = 1 \text{ mA peak}$)		t_f	—	2.5	4	μs

NOTES: 1. Radiation flux density (H) equal to 5 mW/cm^2 emitted from a tungsten source at a color temperature of 2870 K.
 2. Radiation flux density (H) equal to 0.5 mW/cm^2 (pulsed) from a GaAs (gallium-arsenide) source at $\lambda = 940 \text{ nm}$.
 3. For unsaturated response time measurements, radiation is provided by pulsed GaAs (gallium-arsenide) light-emitting diode ($\lambda \approx 940 \text{ nm}$) with a pulse width equal to or greater than 10 microseconds (see Figure 2) $I_L = 1 \text{ mA peak}$.

MRD300, MRD310

TYPICAL CHARACTERISTICS

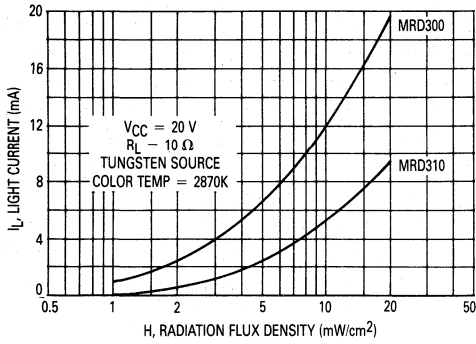

Figure 1. Light Current versus Irradiance

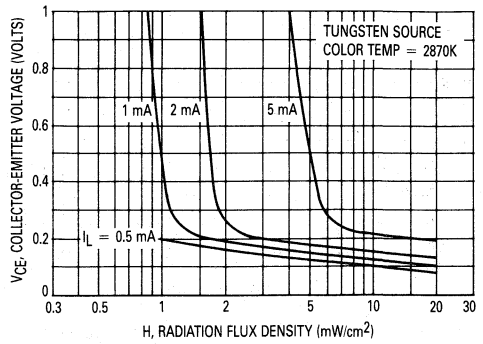

Figure 2. Collector-Emitter Saturation Characteristic

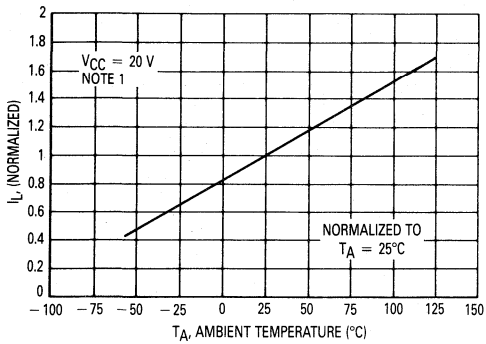

Figure 3. Normalized Light Current versus Temperature

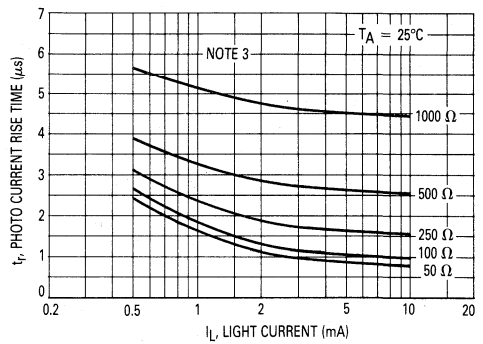

Figure 4. Rise Time versus Light Current

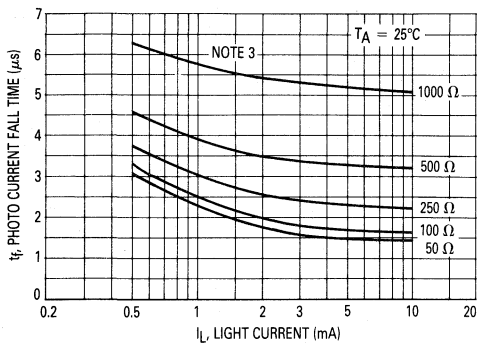

Figure 5. Fall Time versus Light Current

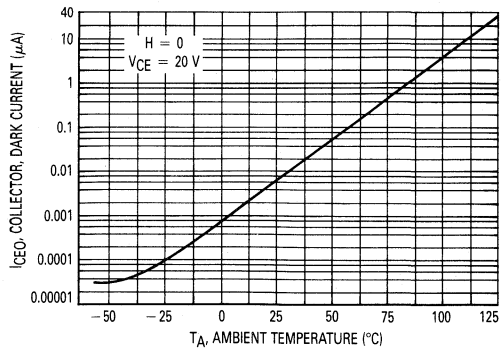

Figure 6. Dark Current versus Temperature

MRD300, MRD310

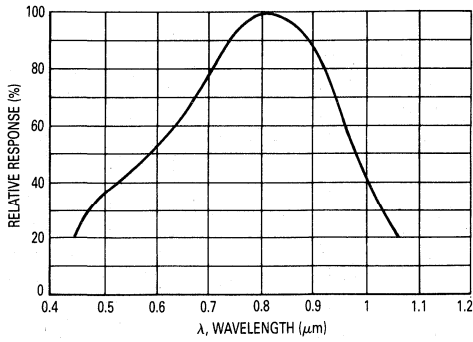

Figure 7. Constant Energy Spectral Response

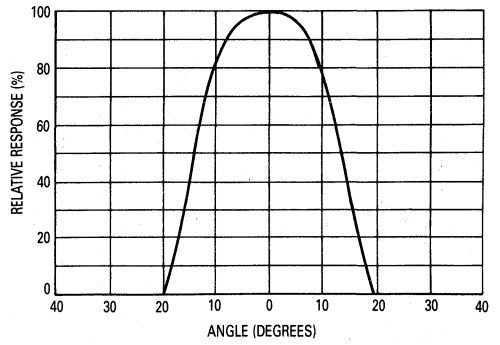

Figure 8. Angular Response

7

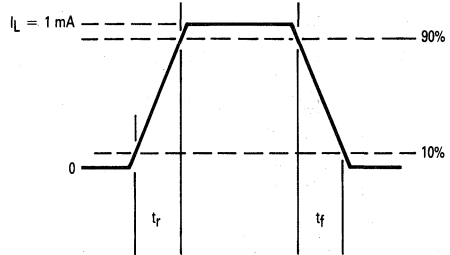
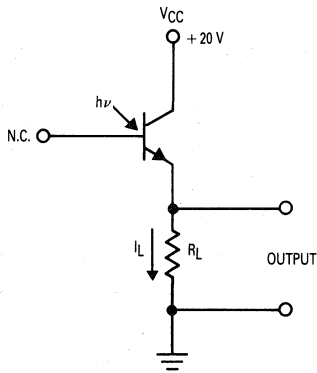

Figure 9. Pulse Response Test Circuit and Waveform

Photo Detector Darlington Output

MRD360

Motorola Preferred Device

**PHOTO DETECTOR
DARLINGTON OUTPUT
NPN SILICON**

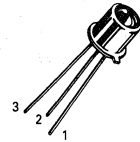

**CASE 82-05
METAL
STYLE 1**

The MRD360 is designed for applications requiring very high radiation sensitivity at low light levels.

Features:

- Popular TO-18 Type Hermetic Package for Easy Handling and Mounting
- Sensitive Throughout Visible and Near Infrared Spectral Range for Wider Application
- Minimum Light Current 12 mA at H = 0.5 mW/cm²
- External Base for Added Control
- Switching Times –
 - $t_r @ I_L = 1 \text{ mA peak} = 40 \mu\text{s (Typ)}$
 - $t_f @ I_L = 1 \text{ mA peak} = 60 \mu\text{s (Typ)}$

Applications:

- Industrial Processing and Control
- Shaft or Position Readers
- Optical Switching
- Remote Control
- Light Modulators
- Punched Card Readers
- Logic Circuits
- Counters

MAXIMUM RATINGS ($T_A = 25^\circ\text{C}$ unless otherwise noted)

Rating	Symbol	Value	Unit
Collector-Emitter Voltage	V_{CE0}	40	Volts
Emitter-Base Voltage	V_{EBO}	10	Volts
Collector-Base Voltage	V_{CBO}	50	Volts
Light Current	I_L	250	mA
Total Device Dissipation @ $T_A = 25^\circ\text{C}$ Derate above 25°C	P_D	250 2.27	mW mW/°C
Operating Temperature Range	T_A	-55 to +125	°C
Storage Temperature Range	T_{stg}	-65 to +150	°C

STATIC ELECTRICAL CHARACTERISTICS ($T_A = 25^\circ\text{C}$ unless otherwise noted)

Characteristic	Symbol	Min	Typ	Max	Unit
Collector Dark Current ($V_{CE} = 10 \text{ V}, H \approx 0$) $T_A = 25^\circ\text{C}$	I_{CE0}	—	10	100	nA
Collector-Base Breakdown Voltage ($I_C = 100 \mu\text{A}$)	$V_{(BR)CBO}$	50	—	—	Volts
Collector-Emitter Breakdown Voltage ($I_C = 100 \mu\text{A}$)	$V_{(BR)CEO}$	40	—	—	Volts
Emitter-Base Breakdown Voltage ($I_E = 100 \mu\text{A}$)	$V_{(BR)EBO}$	10	—	—	Volts

OPTICAL CHARACTERISTICS ($T_A = 25^\circ\text{C}$ unless otherwise noted)

Characteristic	Symbol	Min	Typ	Max	Unit
Light Current ($V_{CC} = 5 \text{ V}, R_L = 10 \text{ Ohms}$) Note 1	I_L	12	20	—	mA
Collector-Emitter Saturation Voltage ($I_L = 10 \text{ mA}, H = 2 \text{ mW/cm}^2$ at 2870K)	$V_{CE(sat)}$	—	—	1	Volt
Photo Current Rise Time (Note 2) ($R_L = 100 \text{ ohms}, I_L = 1 \text{ mA peak}$)	t_r	—	40	100	μs
Photo Current Fall Time (Note 2) ($R_L = 100 \text{ ohms}, I_L = 1 \text{ mA peak}$)	t_f	—	60	150	μs
Wavelength of Maximum Sensitivity	λ_s	—	0.8	—	μm

NOTES: 1. Radiation flux density (H) equal to 0.5 mW/cm² emitted from a tungsten source at a color temperature of 2870 K.
 2. For unsaturated response time measurements, radiation is provided by pulsed GaAs (gallium-arsenide) light-emitting diode ($\lambda \approx 940 \text{ nm}$) with a pulse width equal to or greater than 500 microseconds (see Figure 6) $I_L = 1 \text{ mA peak}$.

7

MRD360

TYPICAL CHARACTERISTICS

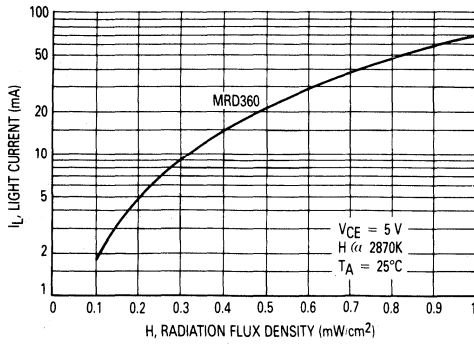

Figure 1. Light Current versus Irradiance

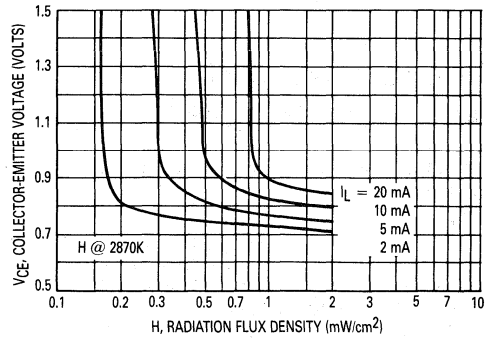

Figure 2. Collector-Emitter Saturation Characteristic

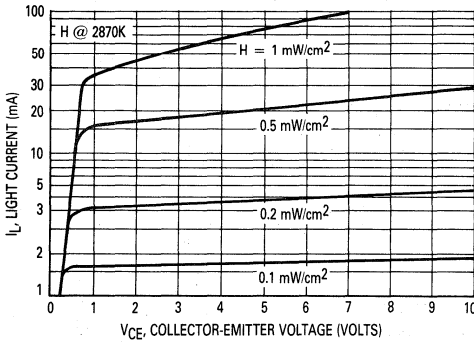

Figure 3. Collector Characteristics

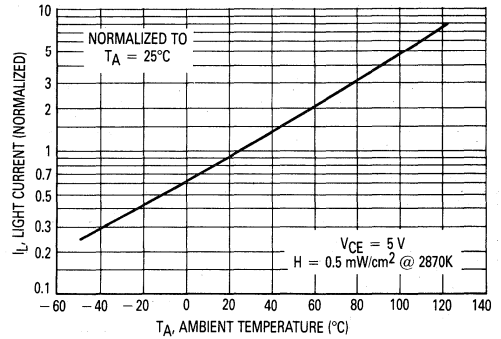

Figure 4. Normalized Light Current versus Temperature

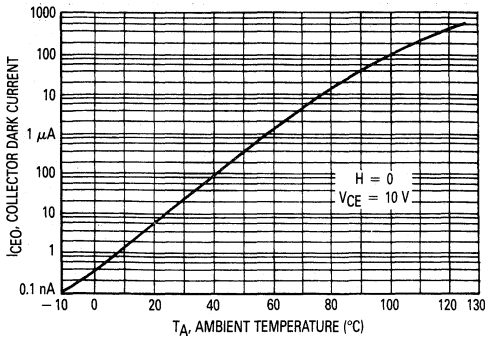

Figure 5. Dark Current versus Temperature

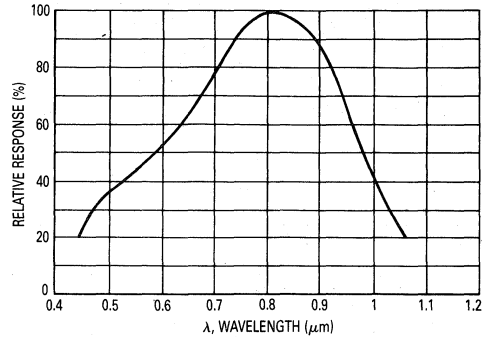

Figure 6. Constant Energy Spectral Response

7

MRD360

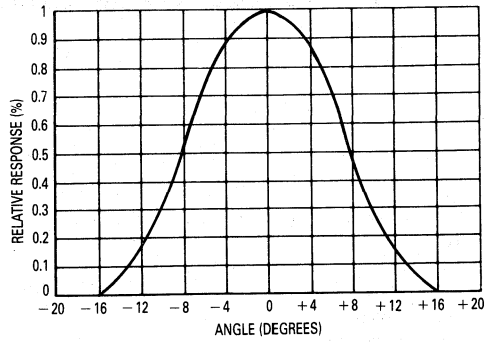

Figure 7. Angular Response

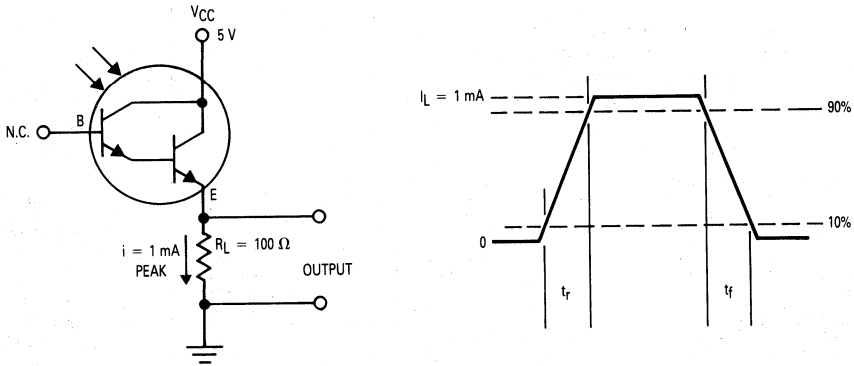

Figure 8. Pulse Response Test Circuit and Waveform

Photo Detectors Diode Output

The MRD500 and MRD510 are designed for applications requiring radiation sensitivity, ultra high-speed, and stable characteristics.

Features:

- Ultra Fast Response — (<1 ns Typ)
- High Sensitivity — MRD500 (1.2 $\mu\text{A}/(\text{mW}/\text{cm}^2)$ Min)
 MRD510 (0.3 $\mu\text{A}/(\text{mW}/\text{cm}^2)$ Min)
- Available With Convex Lens (MRD500) or Flat Glass (MRD510) for Design Flexibility
- Popular TO-18 Type Package for Easy Handling and Mounting
- Sensitive Throughout Visible and Near Infrared Spectral Range for Wide Application
- Annular Passivated Structure for Stability and Reliability

Applications:

- Industrial Processing and Control
- Shaft or Position Readers
- Optical Switching
- Remote Control
- Laser Detection
- Sorters
- Light Modulators
- Punched Card Readers
- Logic Circuits
- Light Demodulation/Detection
- Counters

MAXIMUM RATINGS ($T_A = 25^\circ\text{C}$ unless otherwise noted)

Rating	Symbol	Value	Unit
Reverse Voltage	V_R	100	Volts
Total Power Dissipation @ $T_A = 25^\circ\text{C}$ Derate above 25°C	P_D	250 2.27	mW mW/°C
Operating Temperature Range	T_A	-55 to +125	°C
Storage Temperature Range	T_{stg}	-65 to +150	°C

STATIC ELECTRICAL CHARACTERISTICS ($T_A = 25^\circ\text{C}$ unless otherwise noted)

Characteristic	Fig. No.	Symbol	Min	Typ	Max	Unit
Dark Current ($V_R = 20\text{ V}$, $R_L = 1\text{ megohm}$) Note 2 $T_A = 25^\circ\text{C}$ $T_A = 100^\circ\text{C}$	2 and 3	I_D	— —	— 14	2 —	nA
Reverse Breakdown Voltage ($I_R = 10\ \mu\text{A}$)	—	$V_{(BR)R}$	100	200	—	Volts
Forward Voltage ($I_F = 50\text{ mA}$)	—	V_F	—	—	1.1	Volts
Series Resistance ($I_F = 50\text{ mA}$)	—	R_s	—	—	10	Ohms
Total Capacitance ($V_R = 20\text{ V}$, $f = 1\text{ MHz}$)	5	C_T	—	—	4	pF

OPTICAL CHARACTERISTICS ($T_A = 25^\circ\text{C}$ unless otherwise noted)

Characteristic	MRD500 MRD510	Fig. No.	Symbol	Min	Typ	Max	Unit
Light Current ($V_R = 20\text{ V}$) Note 1	MRD500 MRD510	1	I_L	6 1.5	9 2.1	—	μA
Sensitivity at $0.8\ \mu\text{m}$ ($V_R = 20\text{ V}$) Note 3	MRD500 MRD510	—	$S(\lambda = 0.8\ \mu\text{m})$	— —	6.6 1.5	—	$\mu\text{A}/(\text{mW}/\text{cm}^2)$
Response Time ($V_R = 20\text{ V}$, $R_L = 50\text{ Ohms}$)	—	—	$t(\text{resp})$	—	1	—	ns
Wavelength of Peak Spectral Response	—	5	λ_s	—	0.8	—	μm

NOTES: 1. Radiation Flux Density (H) equal to $5\text{ mW}/\text{cm}^2$ emitted from a tungsten source at a color temperature of 2870 K.
 2. Measured under dark conditions. ($H \approx 0$).
 3. Radiation Flux Density (H) equal to $0.5\text{ mW}/\text{cm}^2$ at $0.8\ \mu\text{m}$.

MRD500* MRD510

*Motorola Preferred Device

**PHOTO DETECTORS
 DIODE OUTPUT
 PIN SILICON
 250 MILLIWATTS
 100 VOLTS**

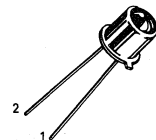

**CASE 209-01
 MRD500
 (CONVEX LENS)
 STYLE 1**

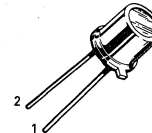

**CASE 210-01
 MRD510
 (FLAT GLASS)
 STYLE 1**

MRD500, MRD510

TYPICAL CHARACTERISTICS

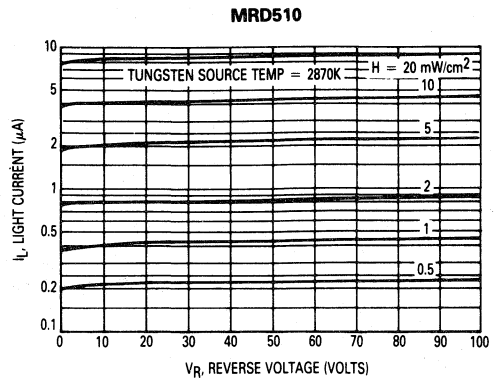
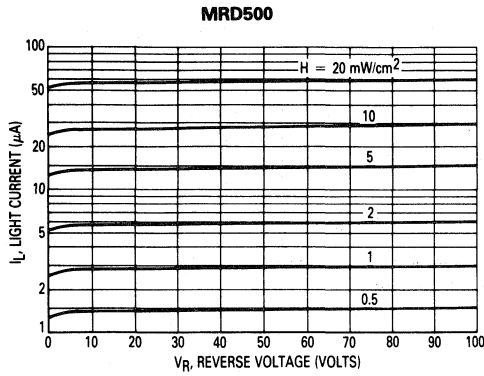

Figure 1. Irradiated Voltage — Current Characteristic

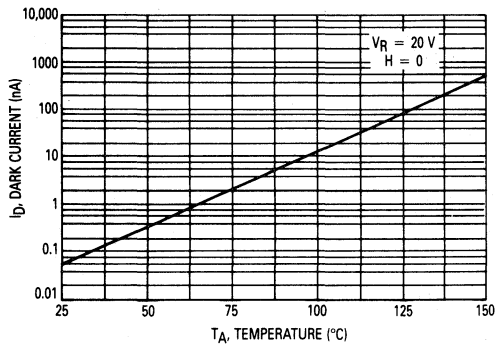

Figure 2. Dark Current versus Temperature

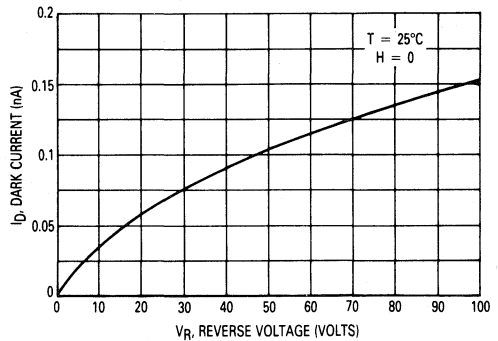

Figure 3. Dark Current versus Reverse Voltage

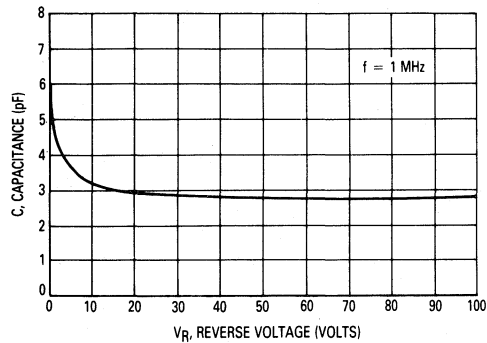

Figure 4. Capacitance versus Voltage

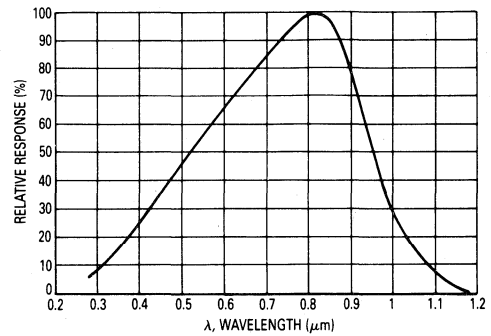

Figure 5. Relative Spectral Response

MRD500, MRD510

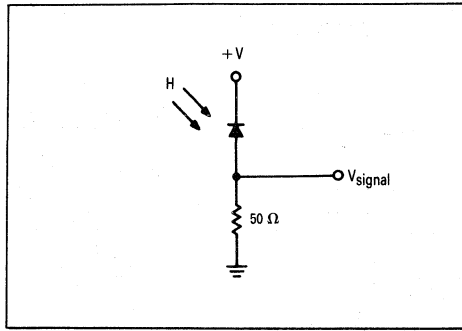

Figure 6. Typical Operating Circuit

Photo Detector Diode Output

This device is designed for infrared remote control and other sensing applications, and can be used in conjunction with the MLED81 infrared emitting diode.

Features:

- Low Cost
- Designed for Automated Handling and Accurate Positioning
- Sensitive Throughout the Near Infrared Spectral Range
- Infrared Filter for Rejection of Visible Light
- High Speed

Applications:

- Remote Controls in Conjunction with MLED81
- Other High Speed Optical Sensing Applications

MAXIMUM RATINGS

Rating	Symbol	Value	Unit
Reverse Voltage	V_R	35	Volts
Forward Current — Continuous	I_F	100	mA
Total Power Dissipation @ $T_A = 25^\circ\text{C}$ Derate above 25°C	P_D	150 3.3	mW mW/ $^\circ\text{C}$
Ambient Operating Temperature Range	T_A	-30 to +70	$^\circ\text{C}$
Storage Temperature	T_{stg}	-40 to +80	$^\circ\text{C}$
Lead Soldering Temperature, 5 seconds max, 1/16 inch from case	—	260	$^\circ\text{C}$

ELECTRICAL CHARACTERISTICS ($T_A = 25^\circ\text{C}$ unless otherwise noted)

Characteristic	Symbol	Min	Typ	Max	Unit
Dark Current ($V_R = 10\text{ V}$)	I_D	—	3	30	nA
Capacitance ($f = 1\text{ MHz}$, $V = 0$)	C_J	—	175	—	pF

OPTICAL CHARACTERISTICS ($T_A = 25^\circ\text{C}$ unless otherwise noted)

Characteristic	Symbol	Min	Typ	Max	Unit
Wavelength of Maximum Sensitivity	λ_{max}	—	940	—	nm
Spectral Range	$\Delta\lambda$	—	170	—	nm
Sensitivity ($\lambda = 940\text{ nm}$, $V_R = 20\text{ V}$)	S	—	50	—	$\mu\text{A}/\text{mW}/\text{cm}^2$
Temperature Coefficient of Sensitivity	ΔS	—	0.18	—	%/K
Acceptance Half-Angle	φ	—	± 70	—	$^\circ$
Short Circuit Current ($E_v = 1000\text{ lux}^1$)	I_S	—	50	—	μA
Open Circuit Voltage ($E_v = 1000\text{ lux}^1$)	V_L	—	0.3	—	V

NOTE 1. E_v is the illumination from an unfiltered tungsten filament source, having a color temperature of 2856K (standard light A, in accordance with DIN5030 and IEC publication 306-1).

MRD821

Motorola Preferred Device

**PHOTO DETECTOR
 DIODE OUTPUT**

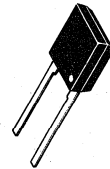

**CASE 381-01
 STYLE 1**

TYPICAL CHARACTERISTICS

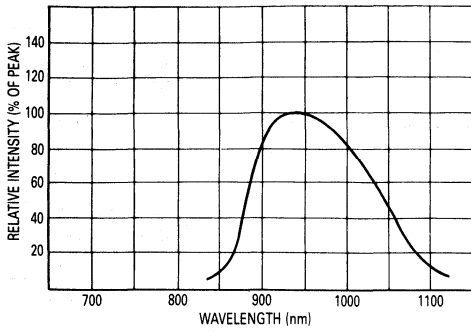

Figure 1. Relative Spectral Sensitivity

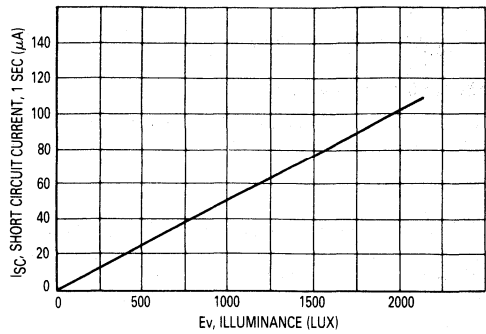

Figure 2. Short Circuit Current versus Illuminance

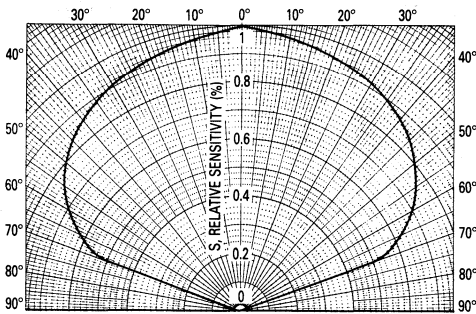

Figure 3. Angular Response

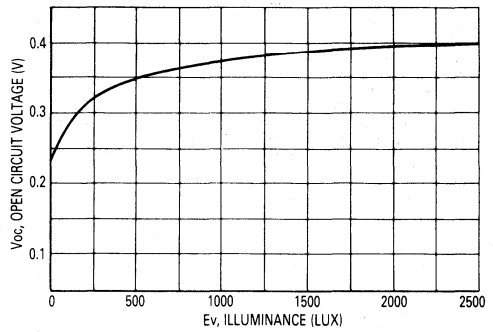

Figure 4. Open Circuit Voltage versus Illuminance

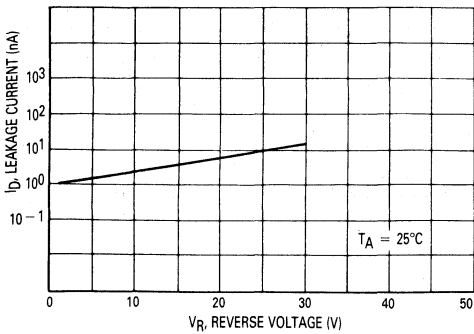

Figure 5. Dark Current versus Reverse Voltage

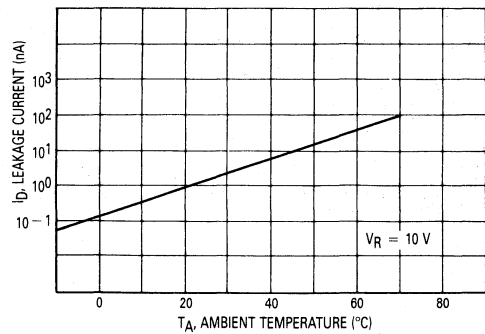

Figure 6. Dark Current versus Temperature

7

MRD821

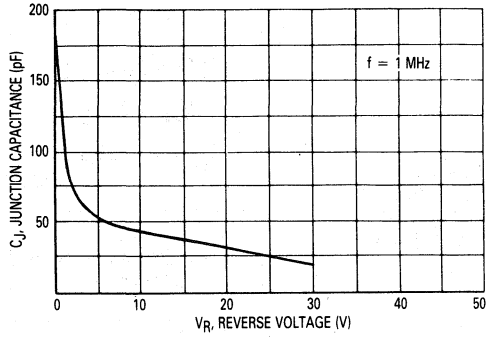

Figure 7. Capacitance versus Reverse Voltage

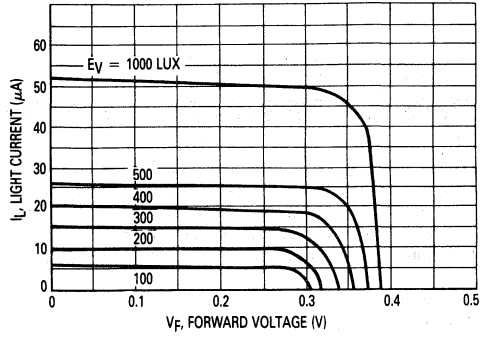

Figure 8. Light Current versus Forward Voltage

Advance Information Phototransistor Detector

The MRD901 series Silicon phototransistor detectors are multi-purpose devices capable for use in many applications. It is a side looking package that is designed for use in PC board mounted interruptive and reflective sensing applications. The device is ideally suited for use with an MLED91 series LED as a light source.

Features:

- Low Cost
- Well Suited For Use with Any MLED91 Series Infrared LED
- New Die Placement Technology Improves Acceptance Angle Symmetry
- New Mold Technology Improves Performance Under Variable Environmental Conditions
- New Lens Design Offers Improved Optical Performance
- EIA 468-A Compliant Tape and Reel Option Available (MRD901RLRE and MRD901ARLRE)

Applications:

- Low Bit Rate Communication Systems
- Keyboards
- Coin Handlers
- Daylight Sensor
- Paper Handlers
- Touch Screens
- Shaft Encoders
- General Purpose Interruptive and Reflective Event Sensors

MRD901 Series

Motorola Preferred Devices

PHOTOTRANSISTOR DETECTOR

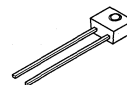

CASE 422A-01
STYLE 2



MAXIMUM RATINGS

Rating	Symbol	Value	Unit
Collector-Emitter Voltage	V_{CEO}	30	Volts
Device Power Dissipation @ $T_A = 25^\circ\text{C}$ (1) Derate above 55°C	P_D	150 2.0	mW mW/ $^\circ\text{C}$
Ambient Operating Temperature	T_{op}	-40 to 100	$^\circ\text{C}$
Storage Temperature	T_{stg}	-40 to 100	$^\circ\text{C}$
Lead Soldering Temperature (2)	T_L	260	$^\circ\text{C}$

ELECTRICAL CHARACTERISTICS ($T_A = 25^\circ\text{C}$ unless otherwise noted)

Characteristic	Symbol	Min	Typ	Max	Unit
Collector Dark Current ($V_{CE} = 10\text{ V}$, $H = 0$ (dark))	I_D	—	10	100	nA
Collector-Emitter Breakdown Voltage ($I_C = 100\ \mu\text{A}$)	BV_{CEO}	30	—	—	Volts

OPTICAL CHARACTERISTICS ($T_A = 25^\circ\text{C}$ unless otherwise noted)

Characteristic	Symbol	Min	Typ	Max	Unit
Collector Light Current ($V_{CE} = 5.0\text{ V}$, $H = 500\ \mu\text{W}/\text{sq cm}$ @ 940 nm) MRD901 MRD901A	I_L	0.1 0.7	1.0 —	— 2.6	mA mA
Saturation Voltage ($H = 10\ \text{mW}/\text{sq cm}$, Wavelength = 940 nm, $I_C = 2.0\ \text{mA}$, $V_{CE} = 5.0\ \text{V}$)	$V_{CE(sat)}$	—	—	0.4	Volts

(1) Measured with device soldered into a typical printed circuit board.

(2) Maximum exposure time: five seconds. Minimum of 1/16 inch from the case. A heat sink should be applied in order to prevent the case temperature from exceeding 100°C .

This document contains information on a new product. Specifications and information herein are subject to change without notice.

Preferred devices are Motorola recommended choices for future use and best overall value.

MRD901 Series

TYPICAL CHARACTERISTICS

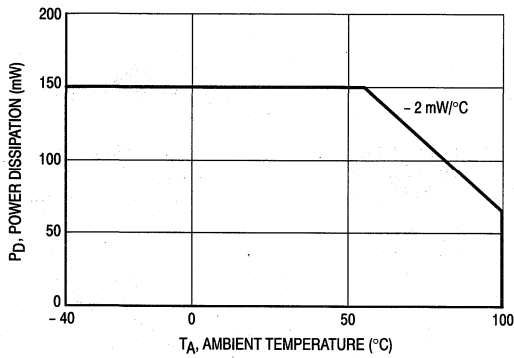

Figure 1. Power Dissipation

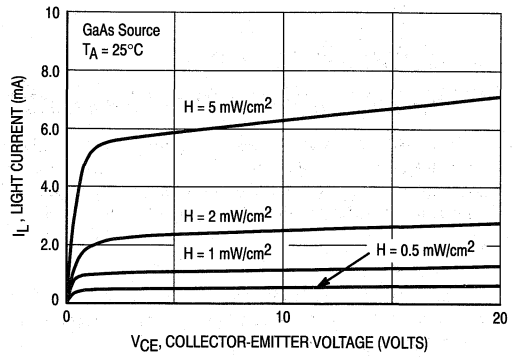

Figure 2. IC versus V_{CE}

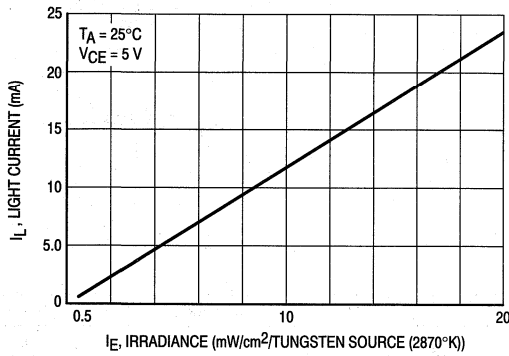

Figure 3. Collector Current versus Irradiance

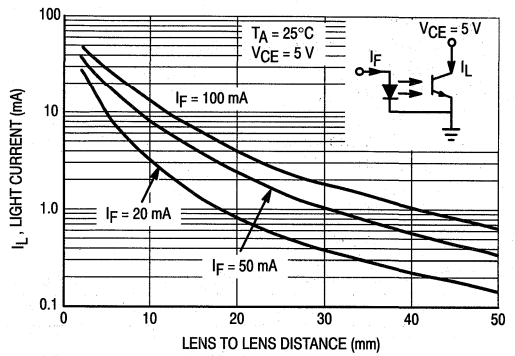

Figure 4. Coupled Characteristics of MLED91 and MRD901

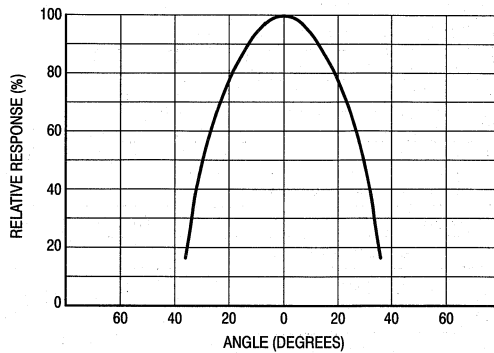

Figure 5. Angular Response

Advance Information PhotoDarlington Detector

The MRD911 Silicon photodetector is a high sensitivity, multi-purpose photodetector. Its side-looking package is designed for use in PC board mounted interruptive, reflective, and light level sensing applications. The device is ideally suited for use with an MLED91 series LED as a light source.

Features:

- Low Cost
- Well Suited For Use with Any MLED91 Series Infrared LED
- New Mold Technology Guarantees Improved Performance Under Variable Environmental Conditions
- New Die Placement Technology Improves Acceptance Angle Symmetry
- High Sensitivity
- EIA 468-A Compliant Tape and Reel Option Available

Applications:

- Low Bit Rate Communication Systems
- Keyboards
- Coin Handlers
- Daylight Sensor
- General Purpose Interruptive and Reflective Event Sensors
- Paper Handlers
- Touch Screens
- Shaft Encoders
- Light Level Sensing

MRD911

Motorola Preferred Device

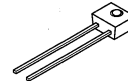

CASE 422A-01
STYLE 2

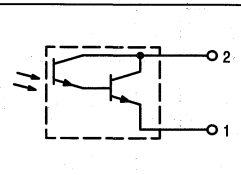

MAXIMUM RATINGS (T_A = 25°C unless otherwise noted)

Rating	Symbol	Value	Unit
Collector-Emitter Voltage	V _{CEO}	60	Volts
Total Device Dissipation @ T _A = 25°C Derate above 25°C (1)	P _D	150 2.0	mW mW/°C
Operating and Storage Junction Temperature Range	T _J , T _{stg}	- 40 to +100	°C
Lead Soldering Temperature (5 sec. max, 1/16" from case) (2)	T _L	260	°C

ELECTRICAL CHARACTERISTICS (T_A = 25°C unless otherwise noted)

Characteristic	Symbol	Min	Typ	Max	Unit
Collector Dark Current (V _{CE} = 10 V, H = 0)	I _D	—	—	100	nA
Collector-Emitter Breakdown Voltage (I _C = 1.0 mA, H = 0)	V _{(BR)CEO}	60	—	—	Volts
Capacitance (V _{CC} = 5.0 V, f = 1.0 MHz)	C _{ce}	—	3.9	—	pF

OPTICAL CHARACTERISTICS (T_A = 25°C unless otherwise noted)

Characteristic	Symbol	Min	Typ	Max	Unit
Collector Light Current (V _{CE} = 5.0 V, H = 500 μW/cm ² , λ = 940 nm)	I _L	5.0	25	—	mA
Turn-On Time H = 500 μW/cm ² , V _{CC} = 5.0 V	t _{on}	—	125	—	μs
	t _{off}	—	150	—	
Saturation Voltage (H = 500 μW/cm ² , λ = 940 nm, I _C = 2.0 mA, V _{CC} = 5.0 V)	V _{CE(sat)}	—	0.75	1.0	Volts
Wavelength of Maximum Sensitivity	λ _s	—	0.8	—	μm

(1) Measured with device soldered into a typical printed circuit board.

(2) Heat sink should be applied to leads during soldering to prevent case temperature from exceeding 100°C.

This document contains information on a new product. Specifications and information herein are subject to change without notice.
Preferred devices are Motorola recommended choices for future use and best overall value.

MRD911

TYPICAL CHARACTERISTICS

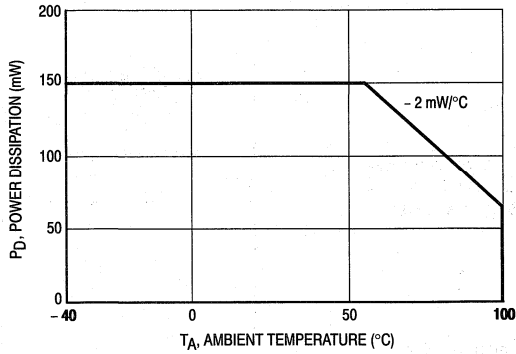

Figure 1. Power Dissipation

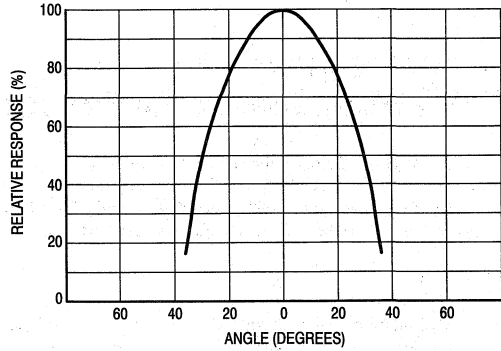

Figure 2. Angular Response

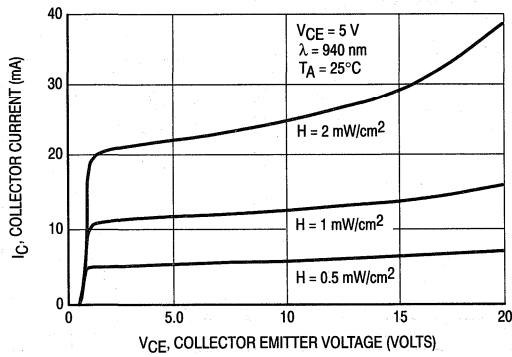

Figure 3. Collector Current versus Collector-Emitter Voltage

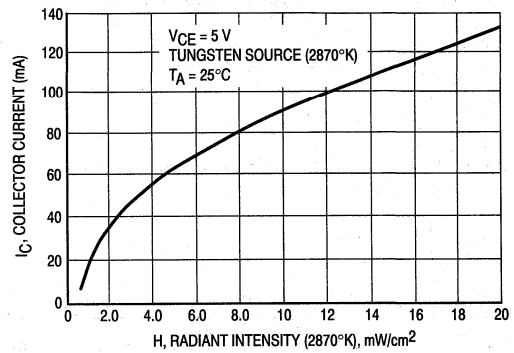

Figure 4. Collector Current versus Radiant Intensity

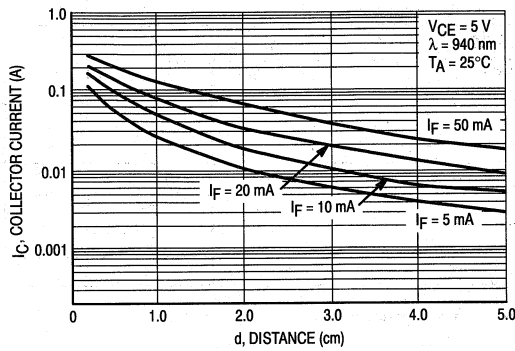

Figure 5. Collector Current versus Distance when Coupled with a Typical MLED91

7

MOTOROLA SEMICONDUCTOR TECHNICAL DATA

Advance Information PIN Photodiode Detector

The MRD921 Silicon Photodiode detectors are high speed, multi-purpose devices for use in multiple applications. The side-looking package is designed for PC Board mounted interruptive, reflective, and light level sensing. The device is ideally suited for use with an MLED91 series LED.

Features:

- Low Cost
- Well Suited For Use with Any MLED91 Series Infrared LED
- New Mold Technology Guarantees Improved Performance Under Variable Environmental Conditions
- New Die Placement Technology Improves Acceptance Angle Symmetry
- EIA 468-A Compliant Tape and Reel Option Available (Specify RLRE Suffix.)

Applications:

- Low Bit Rate Communication Systems
- Keyboards
- Coin Handlers
- Daylight Sensor
- General Purpose Interruptive and Reflective Event Sensors
- Paper Handlers
- Touch Screens
- Shaft Encoders

MRD921

Motorola Preferred Device

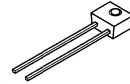

CASE 422A-01
STYLE 1



MAXIMUM RATINGS ($T_A = 25^\circ\text{C}$ unless otherwise noted)

Rating	Symbol	Value	Unit
Reverse Voltage	V_R	100	Volts
Total Power Dissipation @ $T_A = 25^\circ\text{C}$ Derate above 25°C (1)	P_D	150 2.0	mW mW/ $^\circ\text{C}$
Operating and Storage Junction Temperature Range	T_J, T_{stg}	- 40 to +100	$^\circ\text{C}$
Lead Soldering Temperature (5 sec. max, 1/16" from case) (2)	T_L	260	$^\circ\text{C}$

ELECTRICAL CHARACTERISTICS ($T_A = 25^\circ\text{C}$ unless otherwise noted)

Characteristic	Fig. No.	Symbol	Min	Typ	Max	Unit
Dark Current ($V_R = 20\text{ V}$, $R_L = 1.0\text{ M}\Omega$) (3) $T_A = 25^\circ\text{C}$ $T_A = 100^\circ\text{C}$	3 and 4	I_D	— —	0.06 14	10 —	nA
Reverse Breakdown Voltage ($I_R = 10\ \mu\text{A}$)	—	$V_{(BR)R}$	100	200	—	Volts
Forward Voltage ($I_F = 50\text{ mA}$)	—	V_F	—	—	1.1	Volts
Series Resistance ($I_F = 50\text{ mA}$)	—	R_S	—	8.0	—	Ohms
Total Capacitance ($V_R = 20\text{ V}$, $f = 1.0\text{ MHz}$)	5	C_T	—	3.0	—	pF

(1) Measured with the device soldered into a typical printed circuit board.

(2) Heat sink should be applied to leads during soldering to prevent case temperature from exceeding 100°C .

(3) Measured under dark conditions. (H = 0).

This document contains information on a new product. Specifications and information herein are subject to change without notice. Preferred devices are Motorola recommended choices for future use and best overall value.

MRD921

OPTICAL CHARACTERISTICS ($T_A = 25^\circ\text{C}$)

Characteristic	Fig. No.	Symbol	Min	Typ	Max	Unit
Light Current ($V_R = 20\text{ V}$) (4)	2	I_L	1.5	4.0	—	μA
Sensitivity ($V_R = 20\text{ V}$) (5)	—	$S(\lambda = 0.8\ \mu\text{m})$ $S(\lambda = 0.94\ \mu\text{m})$	—	5.0 1.2	—	$\mu\text{A}/\text{mW}/\text{cm}^2$
Response Time ($V_R = 20\text{ V}$, $R_L = 50\ \Omega$)	—	$t(\text{resp})$	—	1.0	—	ns
Wavelength of Peak Spectral Response	6	λ_s	—	0.8	—	μm

(4) Radiation Flux Density (H) equal to $5.0\ \text{mW}/\text{cm}^2$ emitted from a tungsten source at a color temperature of $2870\ \text{K}$.
 (5) Radiation Flux Density (H) equal to $0.5\ \text{mW}/\text{cm}^2$.

TYPICAL CHARACTERISTICS

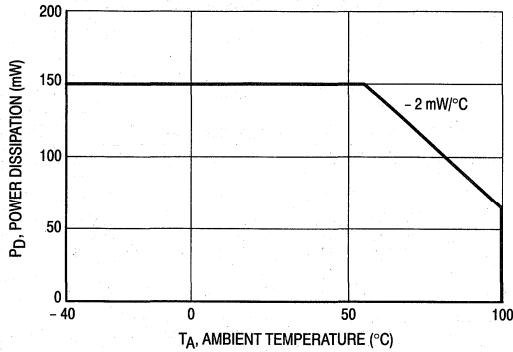

Figure 1. Power Dissipation

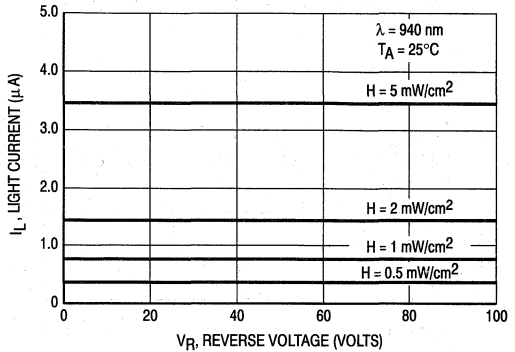

Figure 2. Light Current versus Reverse Voltage

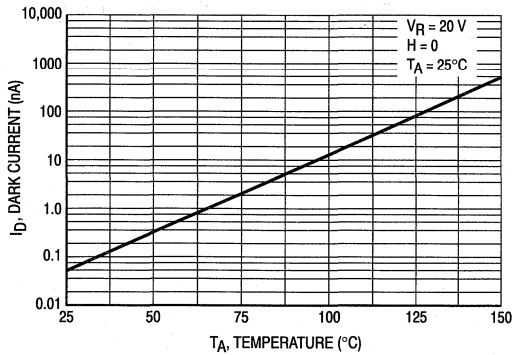

Figure 3. Dark Current versus Temperature

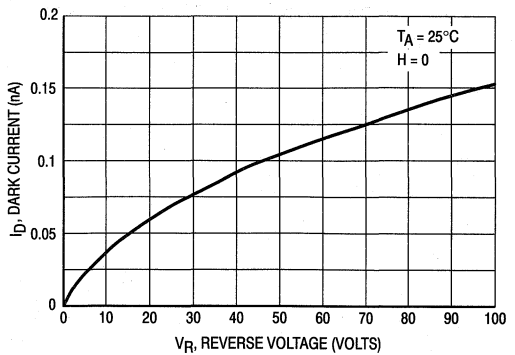

Figure 4. Dark Current versus Reverse Voltage

7

MRD921

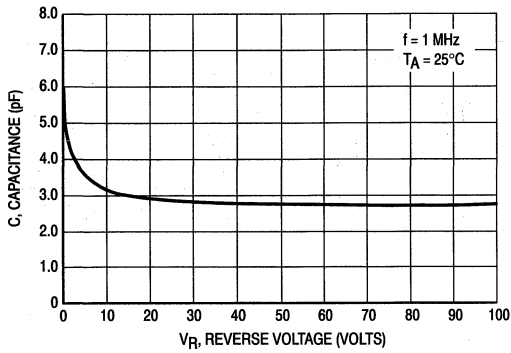

Figure 5. Capacitance versus Voltage

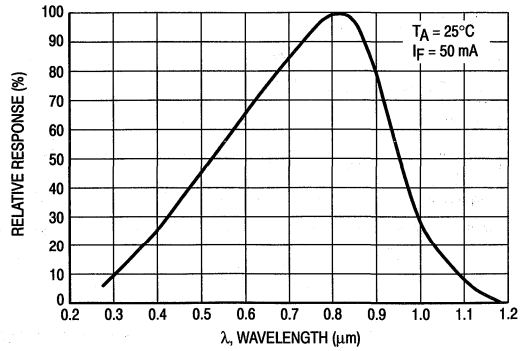

Figure 6. Relative Spectral Response

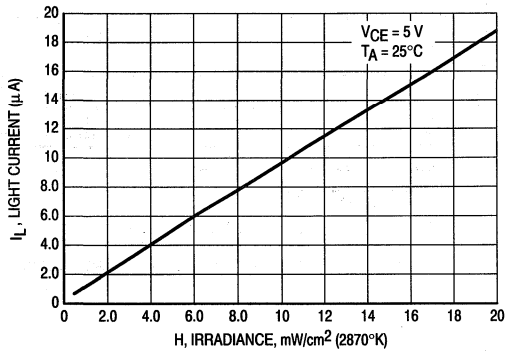

Figure 7. Light Current versus Irradiance

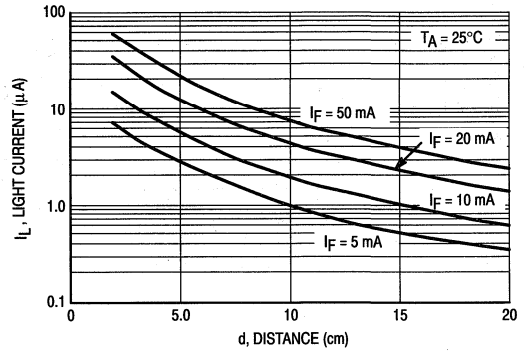

Figure 8. Light Current versus Distance when Coupled with a Typical MLED91

7

MOTOROLA SEMICONDUCTOR TECHNICAL DATA

Advance Information Digital Output Detector

Features:

- Popular Low Cost Plastic Package
- High Coupling Efficiency
- Wide V_{CC} Range
- Ideally Suited for MLED91 Emitter
- Usable to 125 kHz
- Open Collector Output
- Compatible with 3 Volt Systems
- New Mold Technology Improves Performance Under Variable Environmental Conditions
- New Lens Design Offers Improved Optical Performance
- EIA 468-A Compliant Tape and Reel Option Available (MRD950RLRE)

Applications:

- IR Remote Control Receiver
- Shaft Encoders
- Position Sensors
- Interruptive Sensors

MRD950

Motorola Preferred Device

**PHOTO DETECTOR
SCHMITT TRIGGER
OUTPUT**

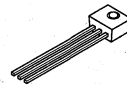

CASE 422-01
Style 3

7

MAXIMUM RATINGS ($T_A = 25^\circ\text{C}$ unless otherwise noted)

Rating	Symbol	Value	Unit
Output Voltage Range	V_O	0 – 16	Volts
Supply Voltage Range	V_{CC}	3 – 16	Volts
Output Current	I_O	50	mA
Device Dissipation Derate above 25°C (1)	P_D	150 2.0	mW mW/ $^\circ\text{C}$
Maximum Operating Temperature	T_A	– 40 to +100	$^\circ\text{C}$
Storage Temperature Range	T_{stg}	– 40 to +100	$^\circ\text{C}$
Lead Soldering Temperature (5 Seconds Maximum) (2)	T_L	260	$^\circ\text{C}$

*Measured with device soldered into a typical PC board.

DEVICE CHARACTERISTICS ($T_A = 25^\circ\text{C}$)

Characteristic	Symbol	Min	Typ	Max	Unit
Operating Voltage	V_{CC}	3.0	—	16	Volts
Supply Current with Output High, Figure 4 ($I_F = 0$, $V_{CC} = 5.0\text{ V}$)	$I_{CC(\text{off})}$	—	1.0	5.0	mA
Output Current, High ($I_F = 0$, $V_{CC} = V_O = 15\text{ V}$, $R_L = 270\ \Omega$)	I_{OH}	—	—	100	μA

(1) Measured with device soldered into a typical printed circuit board.

(2) Maximum exposure time: five seconds. Minimum of 1/16 inch from the case. A heat sink should be applied in order to prevent the case temperature from exceeding 100°C .

This document contains information on a new product. Specifications and information herein are subject to change without notice.

Preferred devices are Motorola recommended choices for future use and best overall value.

MRD950

COUPLED CHARACTERISTICS ($T_A = 0 - 70^\circ\text{C}$)

Characteristic	Symbol	Min	Typ	Max	Unit
Light Required to Trigger (Tungsten Source, 2870 K)	$H_{(on)}$	—	0.50	—	mW/cm^2

The following characteristics are measured with an MLED91 emitter at a separation distance of 4.0 mm (0.155 inches) with the lenses of the emitter and detector on a common axis within 0.1 mm and parallel within 5 degrees.

Supply Current with Output Low, Figure 5 ($I_F = I_{F(on)}$, $V_{CC} = 5.0\text{ V}$)	$I_{CC(on)}$	—	1.6	5.0	mA
Output Voltage, Low ($R_L = 270\ \Omega$, $V_{CC} = 5.0\text{ V}$, $I_F = I_{F(on)}$)	V_{OL}	—	0.2	0.4	Volts
Threshold Current, ON ($R_L = 270\ \Omega$, $V_{CC} = 5.0\text{ V}$)	$I_{F(on)}$	—	10	20	mA
Threshold Current, OFF ($R_L = 270\ \Omega$, $V_{CC} = 5.0\text{ V}$)	$I_{F(off)}$	1.0	7.5	—	mA
Hysteresis Ratio, Figure 1 ($R_L = 270\ \Omega$, $V_{CC} = 5.0\text{ V}$)	$\frac{I_{F(off)}}{I_{F(on)}}$	—	0.75	—	—

SWITCHING CHARACTERISTICS ($T_A = 25^\circ\text{C}$)

Turn-On Time	$R_L = 270\ \Omega$, $V_{CC} = 5.0\text{ V}$, $I_F = I_{F(on)}$	t_{on}	—	0.75	5.0	μs
Fall Time		t_f	—	0.1	—	
Turn-Off Time		t_{off}	—	2.0	5.0	
Rise Time		t_r	—	0.1	—	

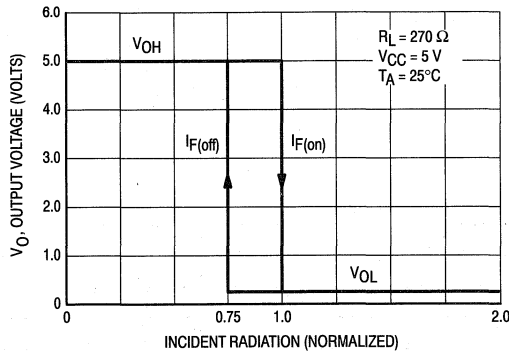

Figure 1. Transfer Characteristics

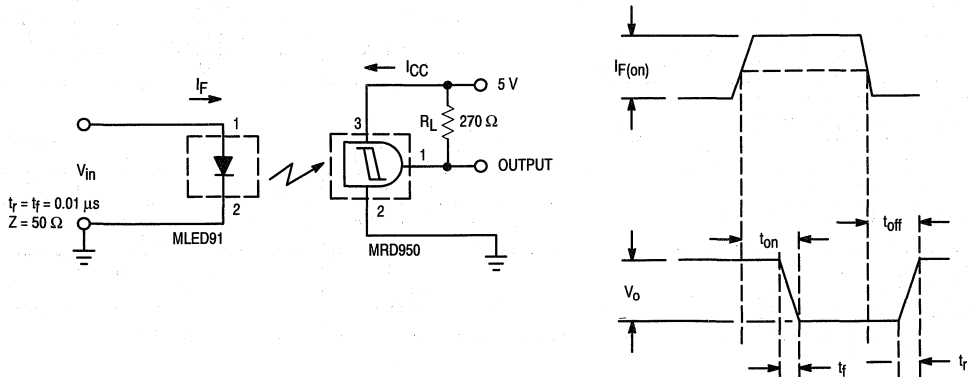

Figure 2. Switching Test Circuit

TYPICAL CHARACTERISTICS

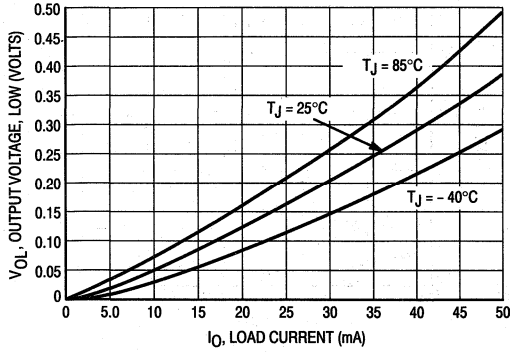

Figure 3. Output Voltage, Low versus Load Current

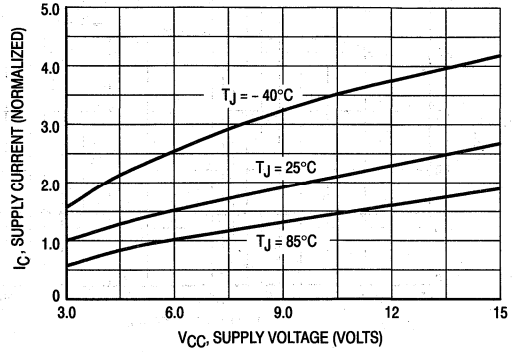

Figure 4. Supply Current versus Supply Voltage — Output High

TYPICAL COUPLED CHARACTERISTICS USING MLED91
EMITTER AND MRD950 DIGITAL OUTPUT DETECTOR

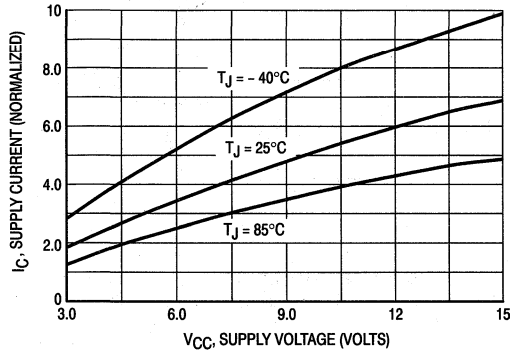

Figure 5. Supply Current versus Supply Voltage — Output Low

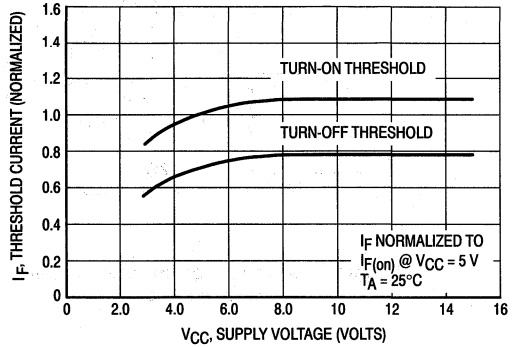

Figure 6. Threshold Current versus Supply Voltage

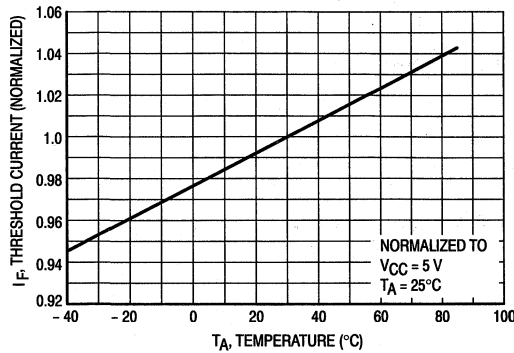

Figure 7. Threshold Current versus Temperature

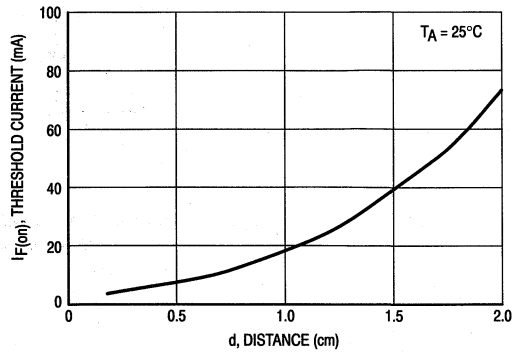

Figure 8. Threshold Current versus Lens Separation Distance at 25°C

MRD950

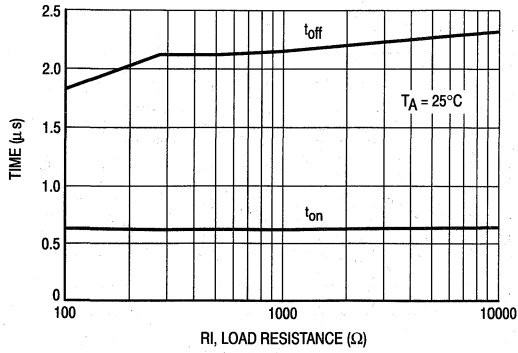

Figure 9. MRD950 Switching Time versus Load Resistance

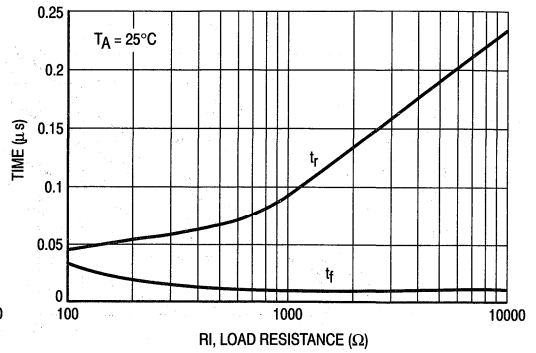

Figure 10. MRD950 Rise Time and Fall Time versus Load Resistance

7

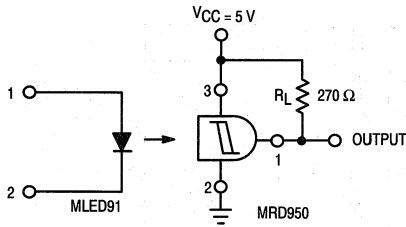

Figure 11. Test Circuit for Threshold Current Measurements

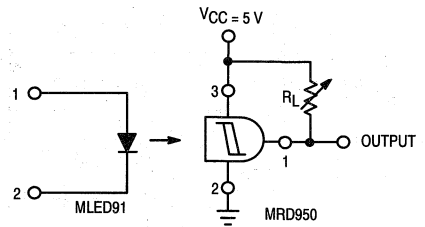

Figure 12. Test Circuit for Output Voltage versus Load Current Measurements

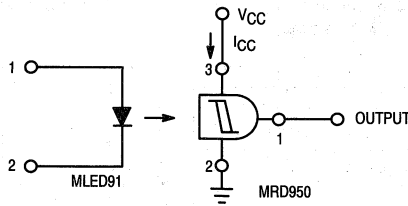

Figure 13. Test Circuit for Supply Current versus Supply Voltage Measurements

Photo Detector Logic Output

The MRD5009 incorporates a Schmitt Trigger which provides hysteresis for noise immunity and pulse shaping. The detector circuit is optimized for simplicity of operation and utilizes an open-collector output for application flexibility.

Features:

- Popular TO-18 Type Package for Easy Handling and Mounting
- High Coupling Efficiency
- Wide V_{CC} Range
- Ideally Suited for Use With MLED930 Emitter
- Usable to 125 kHz
- Hermetic Metal Package for Maximum Stability and Reliability

Applications:

- Industrial Processing and Control
- Shaft or Position Readers
- Optical Switching
- Remote Control
- Light Modulators
- Punched Card Readers
- Logic Circuits
- Light Demodulation/Detection
- Counters

MAXIMUM RATINGS ($T_A = 25^\circ\text{C}$ unless otherwise noted)

Rating	Symbol	Value	Unit
Output Voltage Range	V_O	0-16	Volts
Supply Voltage Range	V_{CC}	0-16	Volts
Output Current	I_O	50	mA
Device Dissipation Derate above 25°C^*	P_D	250 2.27	mW mW/ $^\circ\text{C}$
Maximum Operating Temperature	T_A	-40 to +85	$^\circ\text{C}$
Storage Temperature Range	T_{stg}	-65 to +200	$^\circ\text{C}$
Lead Soldering Temperature (10 seconds maximum)	T_L	260	$^\circ\text{C}$

Characteristic	Symbol	Min	Typ	Max	Unit
----------------	--------	-----	-----	-----	------

DEVICE CHARACTERISTICS ($T_A = 25^\circ\text{C}$)

Operating Voltage	V_{CC}	3	—	15	Volts
Supply Current with Output High, Figure 4 ($I_F = 0, V_{CC} = 5\text{ V}$)	$I_{CC(off)}$	—	1	5	mA
Output Current, High ($I_F = 0, V_{CC} = V_O = 15\text{ V}, R_L = 270\ \Omega$)	I_{OH}	—	—	100	μA

(continued)

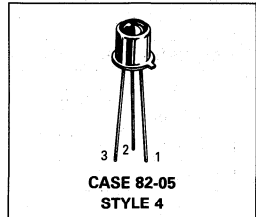
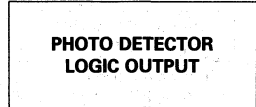
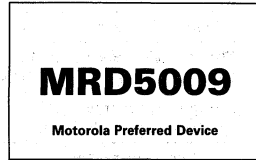

MRD5009

Characteristic	Symbol	Min	Typ	Max	Unit
COUPLED CHARACTERISTICS ($T_A = 0-70^\circ\text{C}$)					
Light Required to Trigger (Tungsten Source, 2870 K)	$H_{(on)}$	—	0.50	—	mW/cm ²
The following characteristics are measured with an MLED930 emitter at a separation distance of 8 mm (0.315 inches) with the lenses of the emitter and detector on a common axis within 0.1 mm and parallel within 5 degrees.					
Supply Current with Output Low, Figure 5 ($I_F = I_{F(on)}$, $V_{CC} = 5\text{ V}$)	$I_{CC(on)}$	—	1.6	5	mA
Output Voltage, Low ($R_L = 270\ \Omega$, $V_{CC} = 5\text{ V}$, $I_F = I_{F(on)}$)	V_{OL}	—	0.2	0.4	volts
Threshold Current, ON ($R_L = 270\ \Omega$, $V_{CC} = 5\text{ V}$)	$I_{F(on)}$	—	10	20	mA
Threshold Current, OFF ($R_L = 270\ \Omega$, $V_{CC} = 5\text{ V}$)	$I_{F(off)}$	1	7.5	—	mA
Hysteresis Ratio, Figure 1 ($R_L = 270\ \Omega$, $V_{CC} = 5\text{ V}$)	$\frac{I_{F(off)}}{I_{F(on)}}$	—	0.75	—	

SWITCHING CHARACTERISTICS ($T_A = 25^\circ\text{C}$)						
Turn-On Time	$R_L = 270\ \Omega$, $V_{CC} = 5\text{ V}$, $I_F = I_{F(on)}$	t_{on}	—	1.2	5	μs
Fall Time		t_f	—	0.1	—	
Turn-Off Time		t_{off}	—	1.2	5	
Rise Time		t_r	—	0.1	—	

7

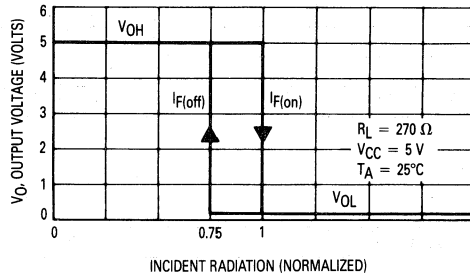

Figure 1. Transfer Characteristics

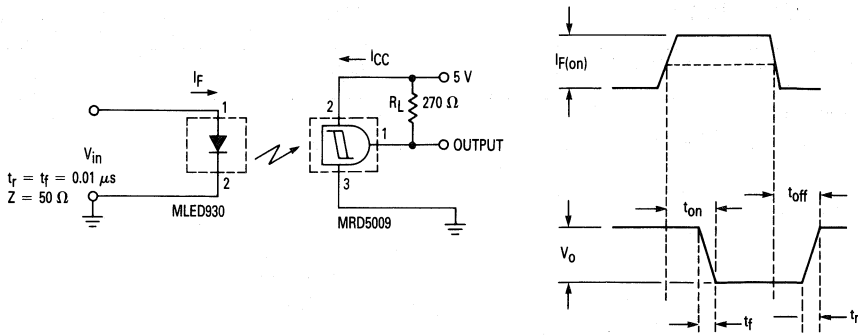

Figure 2. Switching Test Circuit

MRD5009

TYPICAL CHARACTERISTICS

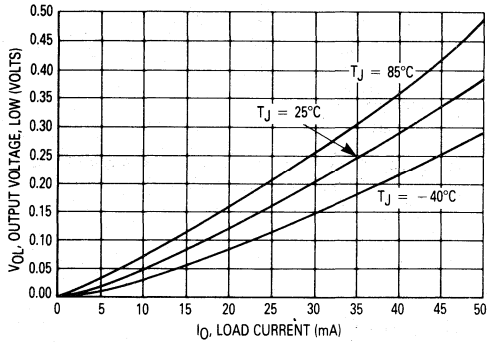

Figure 3. Output Voltage, Low versus Load Current

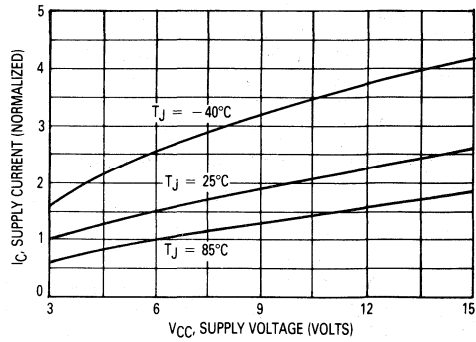

Figure 4. Supply Current versus Supply Voltage — Output High

TYPICAL COUPLED CHARACTERISTICS USING MLED930 EMITTER AND MRD5009 DIGITAL OUTPUT DETECTOR

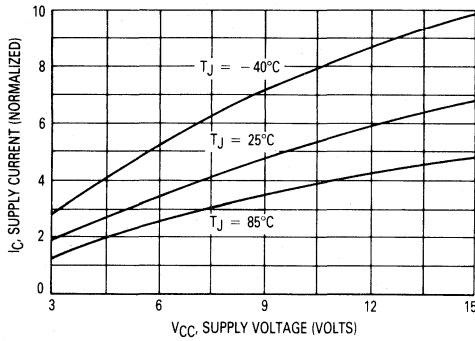

Figure 5. Supply Current versus Supply Voltage — Output Low

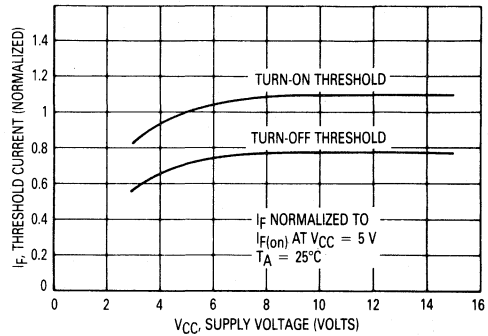

Figure 6. Threshold Current versus Supply Voltage

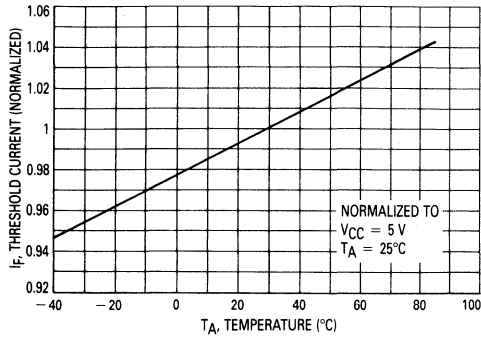

Figure 7. Threshold Current versus Temperature

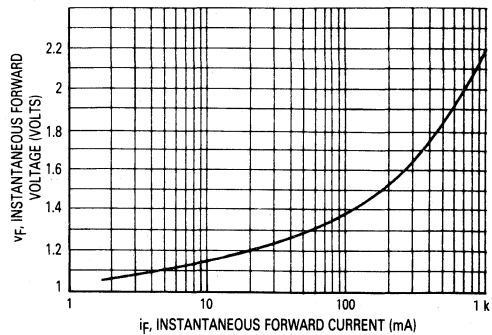

Figure 8. MLED930 Forward Characteristics

7

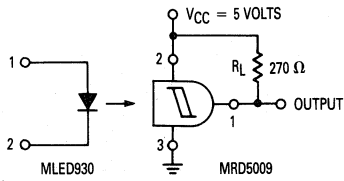

Figure 9. Test Circuit for Threshold Current Measurements

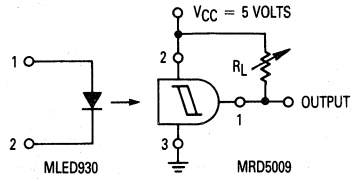

Figure 10. Test Circuit for Output Voltage versus Load Current Measurements

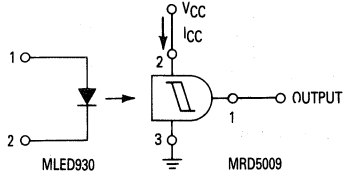
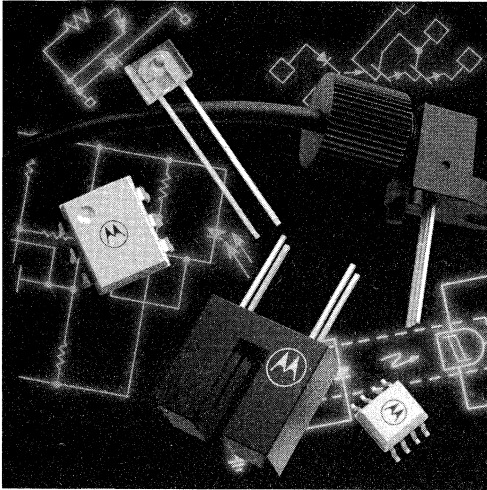

Figure 11. Test Circuit for Supply Current versus Supply Voltage Measurements



Section Eight

Slotted Optical Switches/Interrupters

Transistor Output

H21A Series	8-2
H22A Series	8-2
MOC70 Series	8-10

Dual Channel Transistor Output

MOC70W Series	8-13
---------------------	------

Darlington Output

H21B Series	8-6
H22B Series	8-6
MOC71 Series	8-15

Logic Output

MOC75 Series	8-18
--------------------	------

Slotted Optical Switches Transistor Output

Each device consists of a gallium arsenide infrared emitting diode facing a silicon NPN phototransistor in a molded plastic housing. A slot in the housing between the emitter and the detector provides the means for mechanically interrupting the infrared beam. These devices are widely used as position sensors in a variety of applications.

Features:

- Single Unit for Easy PCB Mounting
- Non-Contact Electrical Switching
- Long-Life Liquid Phase Epi Emitter
- 1 mm Detector Aperture Width

Applications:

Shaft encoders, non-contact switches, position sensing, paper handlers, coin handlers, and general purpose interruptive sensing.

MAXIMUM RATINGS

Rating	Symbol	Value	Unit
--------	--------	-------	------

INPUT LED

Reverse Voltage	V_R	6	Volts
Forward Current — Continuous	I_F	60	mA
Input LED Power Dissipation @ $T_A = 25^\circ\text{C}$ Derate above 25°C	P_D	150 2	mW mW/ $^\circ\text{C}$

OUTPUT TRANSISTOR

Collector-Emitter Voltage	V_{CEO}	30	Volts
Output Current — Continuous	I_C	100	mA
Output Transistor Power Dissipation @ $T_A = 25^\circ\text{C}$ Derate above 25°C	P_D	150 2	mW mW/ $^\circ\text{C}$

TOTAL DEVICE

Ambient Operating Temperature Range	T_A	-40°C to 100°C	$^\circ\text{C}$
Storage Temperature	T_{stg}	-40°C to 100°C	$^\circ\text{C}$
Lead Soldering Temperature (5 seconds max)	—	260	$^\circ\text{C}$
Total Device Power Dissipation @ $T_A = 25^\circ\text{C}$ Derate above 25°C	P_D	300 4	mW mW/ $^\circ\text{C}$

H21A1*
H21A2
H21A3
H22A1*
H22A2
H22A3

*Motorola Preferred Devices

**SLOTTED
 OPTICAL SWITCHES
 TRANSISTOR OUTPUT**

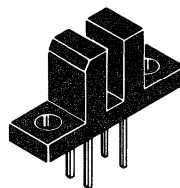

H21A1, 2 AND 3
 CASE 354A-03
 STYLE 1



H22A1, 2 AND 3
 CASE 354-03
 STYLE 1

H21A1, H21A2, H21A3, H22A1, H22A2, H22A3

ELECTRICAL CHARACTERISTICS ($T_A = 25^\circ\text{C}$ unless otherwise noted)

Characteristic	Symbol	Min	Typ	Max	Unit
INPUT LED					
Forward Voltage ($I_F = 60\text{ mA}$)	V_F	0.9	1.34	1.7	Volts
Reverse Leakage ($V_R = 6\text{ V}$)	I_R	—	1	10	μA
Capacitance ($V = 0\text{ V}$, $f = 1\text{ MHz}$)	C_J	—	24	50	pF

OUTPUT TRANSISTOR

Dark Current ($V_{CE} = 25\text{ V}$)	I_{CEO}	—	15	100	nA
Collector-Emitter Breakdown Voltage ($I_C = 1\text{ mA}$)	$V_{(BR)CEO}$	30	45	—	Volts
Emitter-Collector Breakdown Voltage ($I_E = 100\ \mu\text{A}$)	$V_{(BR)ECO}$	6	7.8	—	Volts
Capacitance ($V_{CE} = 5\text{ V}$, $f = 1\text{ MHz}$)	C_{CE}	—	2.5	—	pF
DC Current Gain ($V_{CE} = 5\text{ V}$, $I_C = 2\text{ mA}$)	h_{FE}	—	700	—	—

COUPLED

Output Collector Current ($I_F = 5\text{ mA}$, $V_{CE} = 5\text{ V}$) Note 1	H21A1, H22A1	I_C	0.15	0.3	—	mA
	H21A2, H22A2		0.3	0.6	—	
	H21A3, H22A3		0.6	1	—	
Output Collector Current ($I_F = 20\text{ mA}$, $V_{CE} = 5\text{ V}$) Note 1	H21A1, H22A1	I_C	1	2	—	mA
	H21A2, H22A2		2	4	—	
	H21A3, H22A3		4	7	—	
Output Collector Current ($I_F = 30\text{ mA}$, $V_{CE} = 5\text{ V}$) Note 1	H21A1, H22A1	I_C	1.9	3.8	—	mA
	H21A2, H22A2		3	6	—	
	H21A3, H22A3		5.5	10	—	
Collector-Emitter Saturation Voltage ($I_C = 1.8\text{ mA}$, $I_F = 30\text{ mA}$) Note 1	H21A1, H22A1	$V_{CE(sat)}$	—	0.25	0.4	Volts
Collector-Emitter Saturation Voltage ($I_C = 1.8\text{ mA}$, $I_F = 20\text{ mA}$) Note 1	H21A2, H22A2 H21A3, H22A3		—	0.25	0.4	
Turn-On Time ($I_F = 30\text{ mA}$, $V_{CC} = 5\text{ V}$, $R_L = 2.5\text{ k}\Omega$) Note 1		t_{on}	—	20	—	μs
Turn-Off Time ($I_F = 30\text{ mA}$, $V_{CC} = 5\text{ V}$, $R_L = 2.5\text{ k}\Omega$) Note 1		t_{off}	—	80	—	μs

Notes: 1. No actuator in sensing gap.
2. Stray radiation can alter values of characteristics. Adequate light shielding should be provided.

8

TYPICAL CHARACTERISTICS

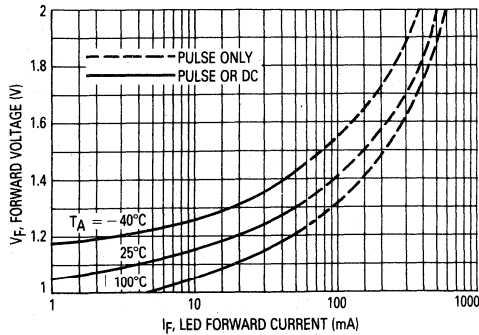

Figure 1. LED Forward Voltage versus Forward Current

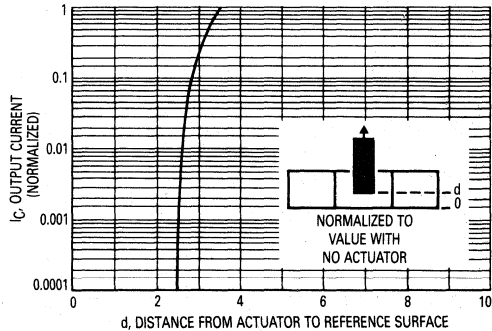

Figure 2. Output Current versus Actuator Position

H21A1, H21A2, H21A3, H22A1, H22A2, H22A3

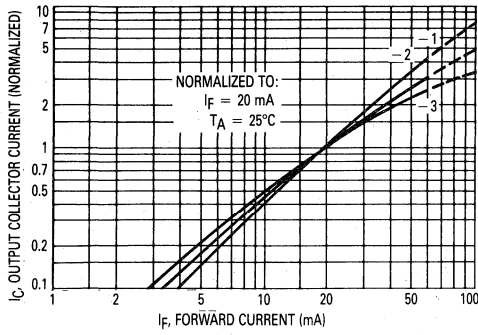

Figure 3. Output Current versus Input Current

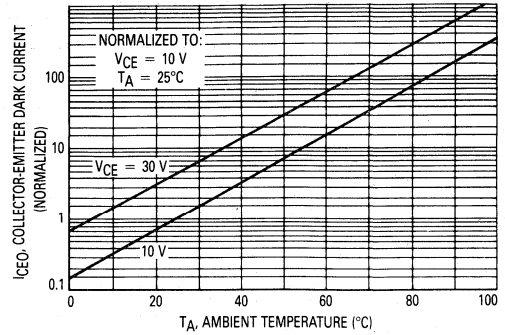

Figure 4. Dark Current versus Ambient Temperature

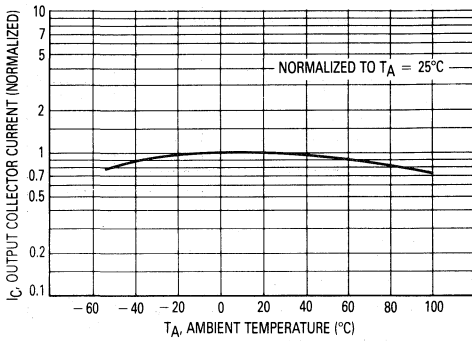

Figure 5. Output Current versus Ambient Temperature

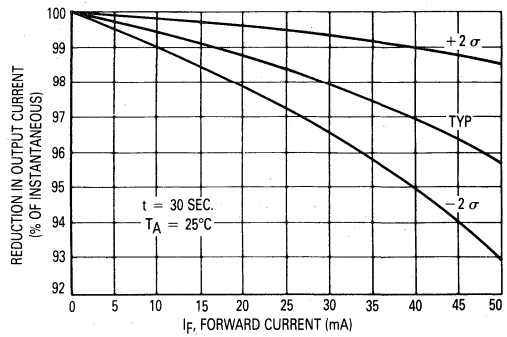

Figure 6. Reduction in Output Current Due to LED Heating versus Forward Current

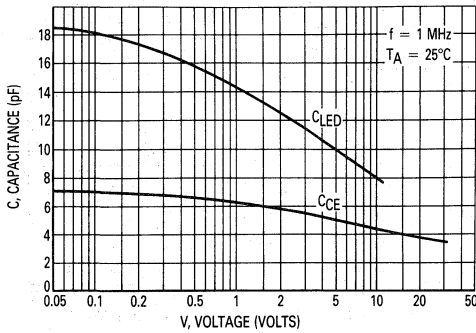

Figure 7. Capacitances versus Voltage

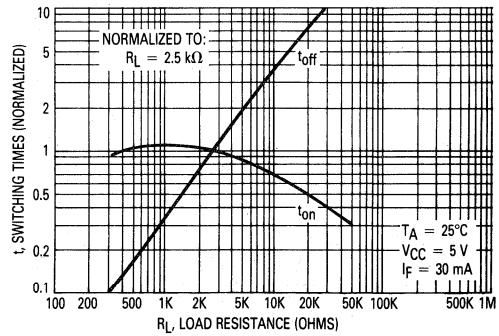

Figure 8. Switching Times versus Load Resistance

H21A1, H21A2, H21A3, H22A1, H22A2, H22A3

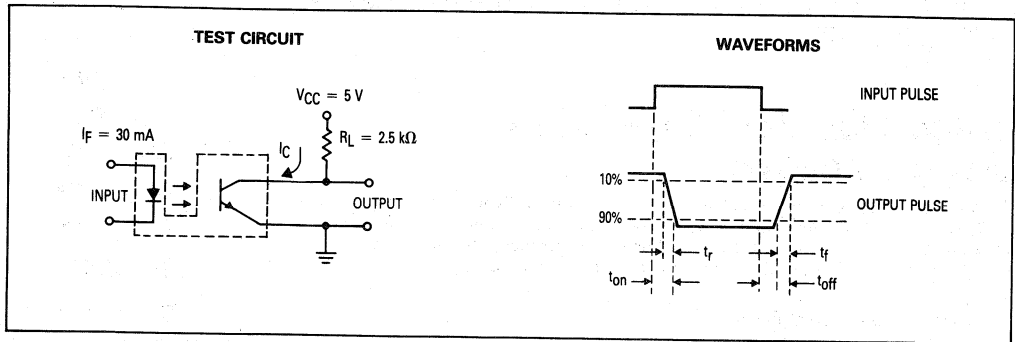

Figure 9. Switching Times

Slotted Optical Switches Darlington Output

These devices each consist of a gallium arsenide infrared emitting diode facing a silicon NPN photodarlington in a molded plastic housing. A slot in the housing between the emitter and the detector provides the means for mechanically interrupting the infrared beam. These devices are widely used as position sensors in a variety of applications.

Features:

- Single Unit for Easy PCB Mounting
- Non-Contact Electrical Switching
- Long-Life Liquid Phase Epi Emitter
- 1 mm Detector Aperture Width

Applications:

Shaft encoders, non-contact switches, position sensing, paper handlers, coin handlers, and general purpose interrupting sensing.

MAXIMUM RATINGS

Rating	Symbol	Value	Unit
--------	--------	-------	------

INPUT LED

Reverse Voltage	V_R	6	Volts
Forward Current — Continuous	I_F	60	mA
Input LED Power Dissipation @ $T_A = 25^\circ\text{C}$ Derate above 25°C	P_D	150 2	mW mW/ $^\circ\text{C}$

OUTPUT DARLINGTON

Collector-Emitter Voltage	V_{CEO}	30	Volts
Output Current — Continuous	I_C	100	mA
Output Darlington Power Dissipation @ $T_A = 25^\circ\text{C}$ Derate above 25°C	P_D	150 2	mW mW/ $^\circ\text{C}$

TOTAL DEVICE

Ambient Operating Temperature Range	T_A	-40°C to 100°C	$^\circ\text{C}$
Storage Temperature	T_{stg}	-40°C to 100°C	$^\circ\text{C}$
Lead Soldering Temperature (5 seconds max)	—	260	$^\circ\text{C}$
Total Device Power Dissipation @ $T_A = 25^\circ\text{C}$ Derate above 25°C	P_D	300 4	mW mW/ $^\circ\text{C}$

ELECTRICAL CHARACTERISTICS ($T_A = 25^\circ\text{C}$ unless otherwise noted)

Characteristic	Symbol	Min	Typ	Max	Unit
----------------	--------	-----	-----	-----	------

INPUT LED

Forward Voltage ($I_F = 60\text{ mA}$)	V_F	0.9	1.34	1.7	Volts
Reverse Leakage ($V_R = 6\text{ V}$)	I_R	—	1	10	μA
Capacitance ($V = 0\text{ V}$, $f = 1\text{ MHz}$)	C_J	—	24	50	pF

(continued)

H21B1*
H21B2
H21B3
H22B1*
H22B2
H22B3

*Motorola Preferred Devices

**SLOTTED
 OPTICAL SWITCHES
 DARLINGTON OUTPUT**

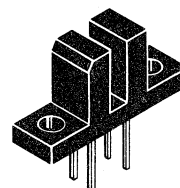

**H21B1, 2 AND 3
 CASE 354A-03
 STYLE 1**



**H22B1, 2 AND 3
 CASE 354-03
 STYLE 1**

H21B1, H21B2, H21B3, H22B1, H22B2, H22B3

ELECTRICAL CHARACTERISTICS — continued ($T_A = 25^\circ\text{C}$ unless otherwise noted)

Characteristic	Symbol	Min	Typ	Max	Unit
OUTPUT DARLINGTON					
Dark Current ($V_{CE} = 25\text{ V}$)	I_{CEO}	—	10	100	nA
Collector-Emitter Breakdown Voltage ($I_C = 1\text{ mA}$)	$V_{(BR)CEO}$	30	90	—	Volts
Emitter-Collector Breakdown Voltage ($I_E = 100\ \mu\text{A}$)	$V_{(BR)ECO}$	7	—	—	Volts
Capacitance ($V_{CE} = 5\text{ V}$, $f = 1\text{ MHz}$)	C_{CE}	—	4	—	pF
DC Current Gain ($V_{CE} = 10\text{ V}$, $I_C = 2\text{ mA}$)	h_{FE}	—	10,000	—	—

COUPLED (Note 1)

Output Collector Current ($I_F = 2\text{ mA}$, $V_{CE} = 1.5\text{ V}$)	H21B1, H22B1	I_C	0.5	1	—	mA
	H21B2, H22B2		1	2	—	
	H21B3, H22B3		2	3.8	—	
Output Collector Current ($I_F = 5\text{ mA}$, $V_{CE} = 1.5\text{ V}$)	H21B1, H22B1	I_C	2.5	5	—	mA
	H21B2, H22B2		5	10	—	
	H21B3, H22B3		10	18	—	
Output Collector Current ($I_F = 10\text{ mA}$, $V_{CE} = 1.5\text{ V}$)	H21B1, H22B1	I_C	7.5	15	—	mA
	H21B2, H22B2		14	28	—	
	H21B3, H22B3		25	40	—	
Collector-Emitter Saturation Voltage ($I_C = 1.8\text{ mA}$, $I_F = 10\text{ mA}$)		$V_{CE(sat)}$	—	—	1	Volts
Collector-Emitter Saturation Voltage ($I_C = 50\text{ mA}$, $I_F = 60\text{ mA}$)	H21B2, H22B2	$V_{CE(sat)}$	—	—	1.5	Volts
	H21B3, H22B3		—	—	1.5	
Turn-On Time ($I_F = 10\text{ mA}$, $V_{CC} = 5\text{ V}$, $R_L = 510\ \Omega$)		t_{on}	—	120	—	μs
Turn-Off Time ($I_F = 10\text{ mA}$, $V_{CC} = 5\text{ V}$, $R_L = 510\ \Omega$)		t_{off}	—	500	—	μs

- Notes: 1. Stray radiation can alter values of characteristics. Adequate light shielding should be provided.
2. No actuator in sensing gap.

8

TYPICAL CHARACTERISTICS

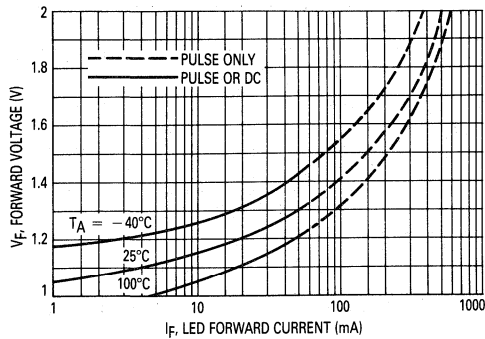

Figure 1. LED Forward Voltage versus Forward Current

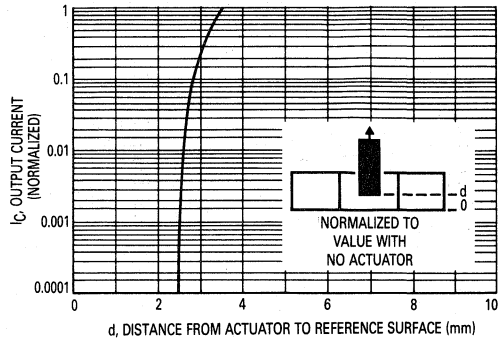

Figure 2. Output Current versus Actuator Position

H21B1, H21B2, H21B3, H22B1, H22B2, H22B3

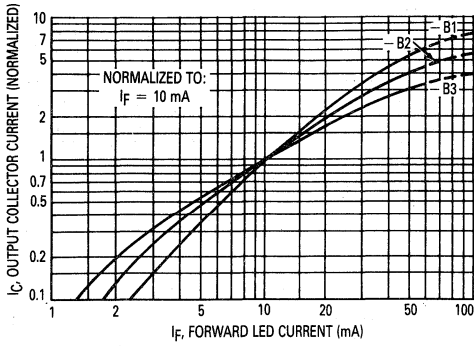

Figure 3. Output Current versus Input Current

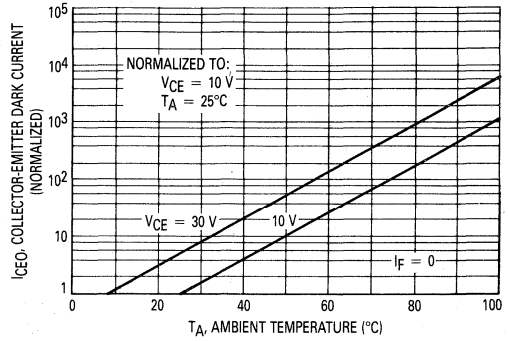

Figure 4. Collector-Emitter Dark Current versus Ambient Temperature

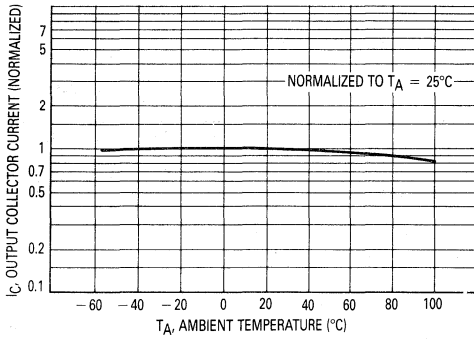

Figure 5. Output Current versus Ambient Temperature

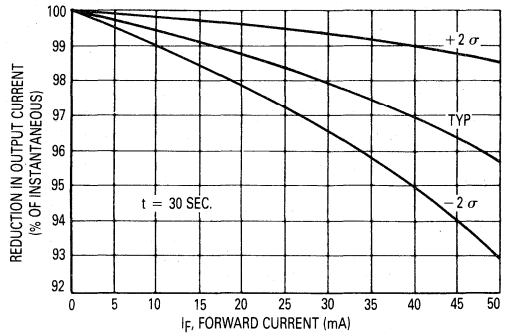

Figure 6. Reduction in Output Current Due to LED Heating versus Forward Current

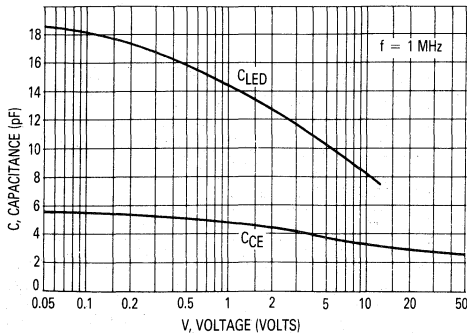

Figure 7. Capacitances versus Voltage

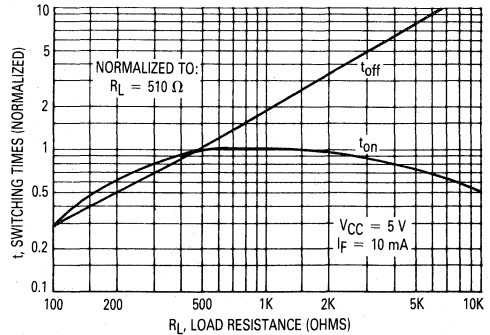

Figure 8. Switching Times versus Load Resistance

H21B1, H21B2, H21B3, H22B1, H22B2, H22B3

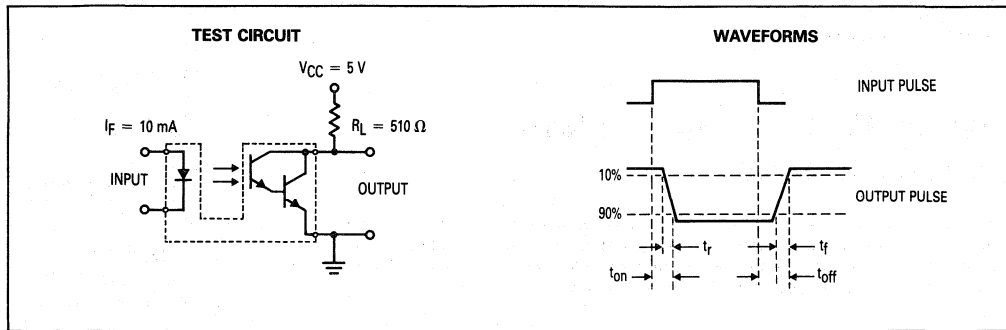

Figure 9. Switching Times

Slotted Optical Switches Transistor Output

These devices each consist of a gallium arsenide infrared emitting diode facing a silicon NPN phototransistor in a molded plastic housing. A slot in the housing between the emitter and the detector provides the means for mechanically interrupting the infrared beam. These devices are widely used as position sensors in a variety of applications.

Features:

- Single Unit for Easy PCB Mounting
- Non-Contact Electrical Switching
- Long-Life Liquid Phase Epi Emitter
- Several Convenient Package Styles

Applications:

Shaft encoders, non-contact switches, position sensing, paper handlers, coin handlers, and general purpose interruptive sensing.

MAXIMUM RATINGS

Rating	Symbol	Value	Unit
--------	--------	-------	------

INPUT LED

Reverse Voltage	V_R	6	Volts
Forward Current — Continuous	I_F	60	mA
Input Transistor Power Dissipation @ $T_A = 25^\circ\text{C}$ Derate above 25°C	P_D	150 2	mW mW/°C

OUTPUT TRANSISTOR

Collector-Emitter Voltage	V_{CEO}	30	Volts
Output Current — Continuous	I_C	100	mA
Output Transistor Power Dissipation @ $T_A = 25^\circ\text{C}$ Derate above 25°C	P_D	150 2	mW mW/°C

TOTAL DEVICE

Ambient Operating Temperature Range	T_A	-40 to +100	°C
Storage Temperature	T_{stg}	-40 to +100	°C
Lead Soldering Temperature (5 seconds max)	—	260	°C
Total Device Power Dissipation @ $T_A = 25^\circ\text{C}$ Derate above 25°C	P_D	300 4	mW mW/°C

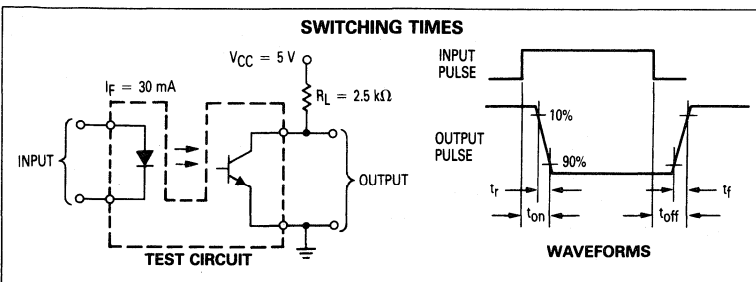

MOC70 Series

*MOC70T1 and MOC70U1
 are Motorola Preferred Devices

SLOTTED OPTICAL SWITCHES TRANSISTOR OUTPUT

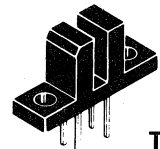

T

CASE 354A-03
 STYLE 1



U

CASE 354-03
 STYLE 1

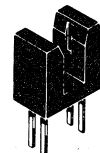

V

CASE 354G-02
 STYLE 1

PART NUMBER DERIVATION

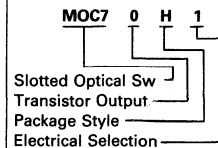

MOC70 Series

ELECTRICAL CHARACTERISTICS ($T_A = 25^\circ\text{C}$ unless otherwise noted. Note 1.)

Characteristic	Symbol	Min	Typ	Max	Unit
INPUT LED					
Forward Voltage ($I_F = 50\text{ mA}$)	V_F	0.9	1.3	1.8	Volts
Reverse Leakage ($V_R = 6\text{ V}$)	I_R	—	1	100	μA
Capacitance ($V = 0\text{ V}$, $f = 1\text{ MHz}$)	C_J	—	18	—	pF

OUTPUT TRANSISTOR

Dark Current ($V_{CE} = 10\text{ V}$)	I_{CEO}	—	5	100	nA
Collector-Emitter Breakdown Voltage ($I_C = 10\text{ mA}$)	$V_{(BR)CEO}$	30	45	—	Volts
Emitter-Collector Breakdown Voltage ($I_E = 100\text{ }\mu\text{A}$)	$V_{(BR)ECO}$	5	7	—	Volts
DC Current Gain ($V_{CE} = 10\text{ V}$, $I_C = 2\text{ mA}$)	h_{FE}	—	700	—	—

COUPLED (Note 2)

Output Collector Current ($I_F = 5\text{ mA}$, $V_{CE} = 10\text{ V}$)	MOC70_1	I_C	0.15	0.3	—	mA
	MOC70_2		0.3	0.6	—	
	MOC70_3		0.6	1	—	
Output Collector Current ($I_F = 20\text{ mA}$, $V_{CE} = 10\text{ V}$)	MOC70_1	I_C	1	2	—	mA
	MOC70_2		2	4	—	
	MOC70_3		4	7	—	
Output Collector Current ($I_F = 30\text{ mA}$, $V_{CE} = 10\text{ V}$)	MOC70_1	I_C	1.9	3.8	—	mA
	MOC70_2		3	6	—	
	MOC70_3		5.5	10	—	
Collector-Emitter Saturation Voltage ($I_C = 1.8\text{ mA}$, $I_F = 30\text{ mA}$)	MOC70_1	$V_{CE(sat)}$	—	0.25	0.4	Volts
Collector-Emitter Saturation Voltage ($I_C = 1.8\text{ mA}$, $I_F = 20\text{ mA}$)	MOC70_2	$V_{CE(sat)}$	—	0.25	0.4	Volts
	MOC70_3		—	0.25	0.4	
Turn-On Time ($I_F = 30\text{ mA}$, $V_{CE} = 5\text{ V}$, $R_L = 2.5\text{ k}\Omega$)		t_{on}	—	20	—	μs
Turn-Off Time ($I_F = 30\text{ mA}$, $V_{CE} = 5\text{ V}$, $R_L = 2.5\text{ k}\Omega$)		t_{off}	—	80	—	μs

Notes: 1. Stray radiation can alter values of characteristics. Adequate light shielding should be provided.
2. No actuator in sensing gap.

8

TYPICAL CHARACTERISTICS

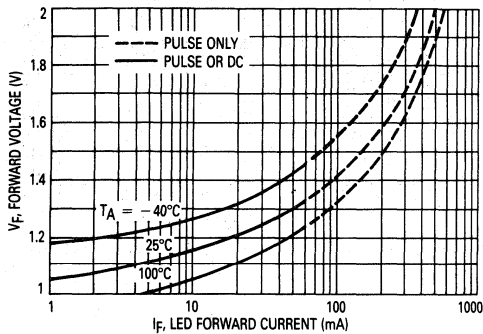

Figure 1. LED Forward Voltage versus Forward Current

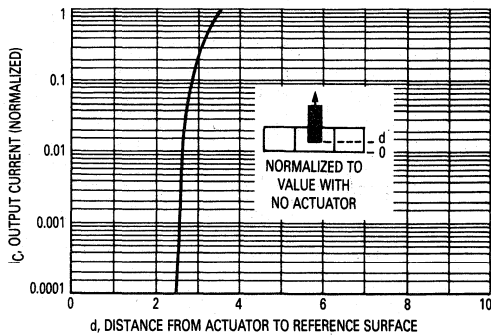

Figure 2. Output Current versus Actuator Position

MOC70 Series

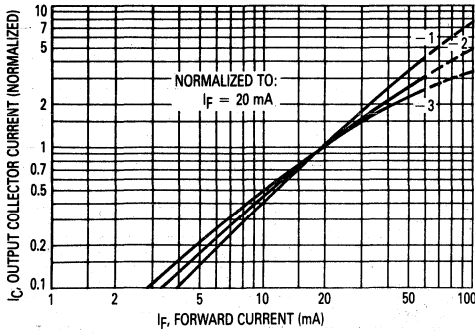

Figure 3. Output Current versus Input Current

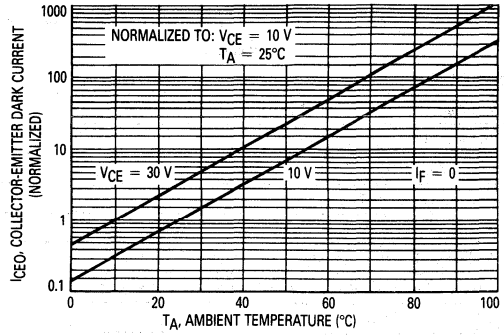

Figure 4. Dark Current versus Ambient Temperature

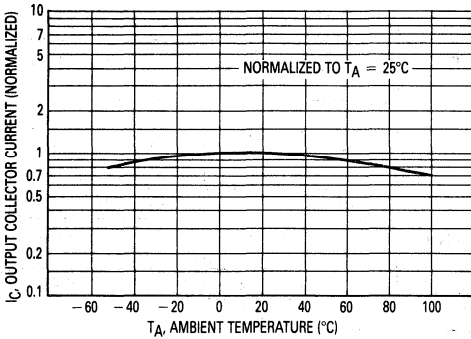

Figure 5. Output Current versus Ambient Temperature

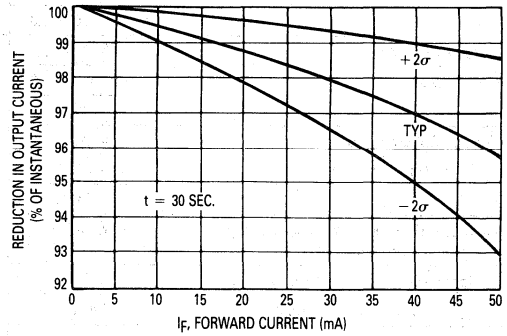

Figure 6. Reduction in Output Current Due to LED Heating versus Forward Current

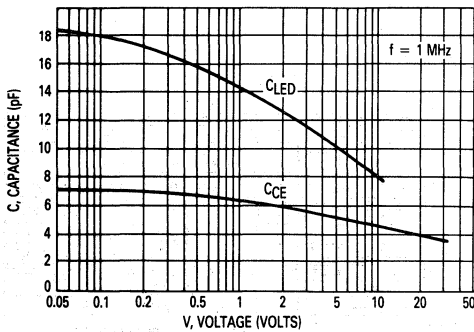

Figure 7. Capacitances versus Voltage

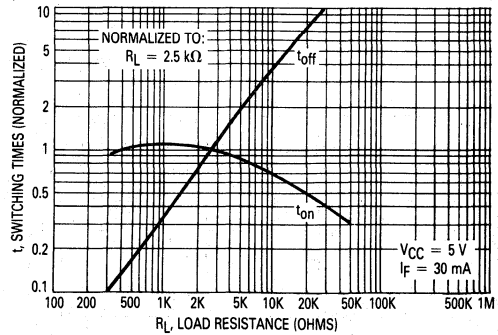

Figure 8. Switching Times versus Load Resistance

Slotted Optical Switches

Transistor Output

These devices consist of two gallium arsenide infrared emitting diodes facing two NPN silicon phototransistors across a 0.100" wide slot in the housing. Switching takes place when an opaque object in the slot interrupts the infrared beam.

In addition to their use in position and motion indicators, dual channel interrupters enable the sensing of *direction* of motion.

Features:

- 0.020" Aperture Width
- Easy PCB Mounting
- Cost Effective
- Uses Long-Lived LPE IRED

Application:

Quadrature sensing, shaft encoders, non-contact switching, multi-level position sensing, coin handlers, and special purpose interruptive sensing.

ABSOLUTE MAXIMUM RATINGS (25°C)

Rating	Symbol	Value	Unit
--------	--------	-------	------

INPUT LED

Power Dissipation	P _D	150*	mW
Forward Current (Continuous)	I _F	60	mA
Reverse Voltage	V _R	6	V

OUTPUT TRANSISTOR

Power Dissipation	P _D	150*	mW
Collector-Emitter Voltage	V _{CEO}	30	V

TOTAL DEVICE

Storage Temperature	T _{stg}	-40 to +85	°C
Operating Temperature	T _J	-40 to +85	°C
Lead Soldering Temperature (5 seconds maximum)	T _L	260	°C

*Derate 2 mW/°C above 25°C ambient.

INDIVIDUAL ELECTRICAL CHARACTERISTICS (25°C) (See Note 1)

Characteristic	Symbol	Min	Typ	Max	Unit
----------------	--------	-----	-----	-----	------

INPUT LED

Reverse Breakdown Voltage (I _R = 100 μA)	V _{(BR)R}	6	—	—	V
Forward Voltage (I _F = 50 mA)	V _F	—	1.3	1.8	V
Reverse Current (V _R = 6 V, R _L = 1 MΩ)	I _R	—	50	—	nA
Capacitance (V = 0 V, f = 1 MHz)	C	—	25	50	pF

OUTPUT TRANSISTOR

Breakdown Voltage (I _C = 10 mA, H ≈ 0)	V _{(BR)CEO}	30	—	—	V
Collector Dark Current (V _{CE} = 10 V, H ≈ 0, Note 1)	I _{CEO}	—	—	100	nA

NOTE 1: Stray irradiation can alter values of characteristics. Adequate shielding should be provided.

MOC70W1*
MOC70W2

*Motorola Preferred Device

**DUAL CHANNEL
 SLOTTED
 OPTICAL SWITCHES
 TRANSISTOR OUTPUT**

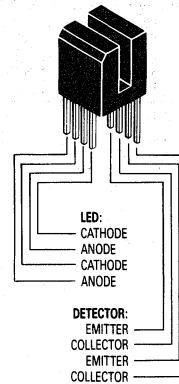

**CASE 792-01
 STYLE 2**

MOC70W1, MOC70W2

COUPLED ELECTRICAL CHARACTERISTICS (25°C, See Note 1)

Characteristics	Symbol	MOC70W1			MOC70W2			Unit
		Min	Typ	Max	Min	Typ	Max	
$I_F = 20 \text{ mA}, V_{CE} = 10 \text{ V}$	$I_{CE(on)}$	100	—	—	250	—	—	μA
$I_F = 20 \text{ mA}, I_C = 50 \mu\text{A}$	$V_{CE(sat)}$	—	—	0.4	—	—	—	V
$I_F = 20 \text{ mA}, I_C = 125 \mu\text{A}$	$V_{CE(sat)}$	—	—	—	—	0.4	—	V
I_F (opposite LED) = 20 mA, $V_{CE} = 10 \text{ V}$	I_{CX}	—	20	—	—	20	—	μA

NOTE 1: Stray irradiation can alter values of characteristics. Adequate shielding should be provided.

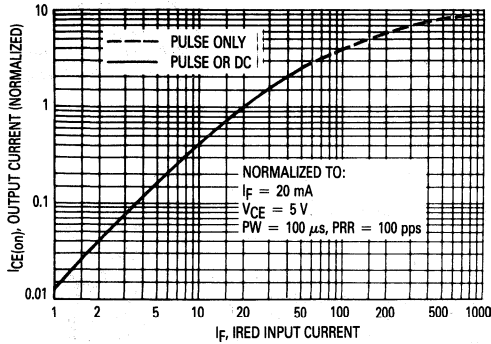

Figure 1. Typical Output Current versus Input Current

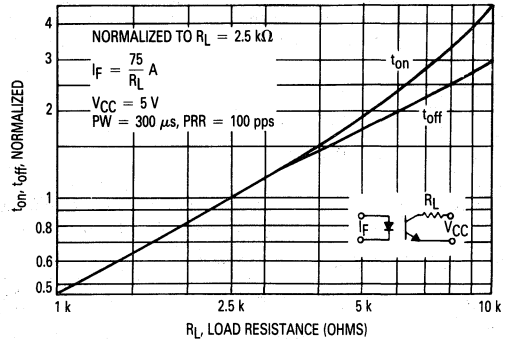

Figure 2. Typical t_{on} , t_{off} versus Load Resistance

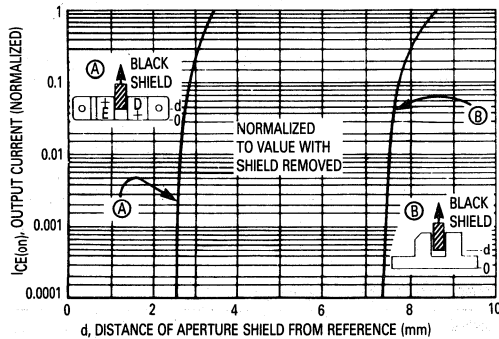

Figure 3. Typical Output Current versus Position of Shield Covering Aperture

Slotted Optical Switches Darlingtion Output

Each device consists of a gallium arsenide infrared emitting diode facing a silicon NPN photodarlington in a molded plastic housing. A slot in the housing between the emitter and the detector provides the means for mechanically interrupting the infrared beam. These devices are widely used as position sensors in a variety of applications.

- Single Unit for Easy PCB Mounting
- Non-Contact Electrical Switching
- Long-Life Liquid Phase Epi Emitter
- Several Convenient Package Styles

MAXIMUM RATINGS

Rating	Symbol	Value	Unit
INPUT LED			
Reverse Voltage	V_R	6	Volts
Forward Current — Continuous	I_F	60	mA
Input LED Power Dissipation @ $T_A = 25^\circ\text{C}$ Derate above 25°C	P_D	150 2	mW mW/ $^\circ\text{C}$

OUTPUT DARLINGTON

Collector-Emitter Voltage	V_{CEO}	30	Volts
Output Current — Continuous	I_C	100	mA
Output Darlingtion Power Dissipation @ $T_A = 25^\circ\text{C}$ Derate above 25°C	P_D	150 2	mW mW/ $^\circ\text{C}$

TOTAL DEVICE

Ambient Operating Temperature Range	T_A	-40 to +100	$^\circ\text{C}$
Storage Temperature	T_{stg}	-40 to +100	$^\circ\text{C}$
Lead Soldering Temperature (5 seconds max)	—	260	$^\circ\text{C}$
Total Device Power Dissipation @ $T_A = 25^\circ\text{C}$ Derate above 25°C	P_D	300 4	mW mW/ $^\circ\text{C}$

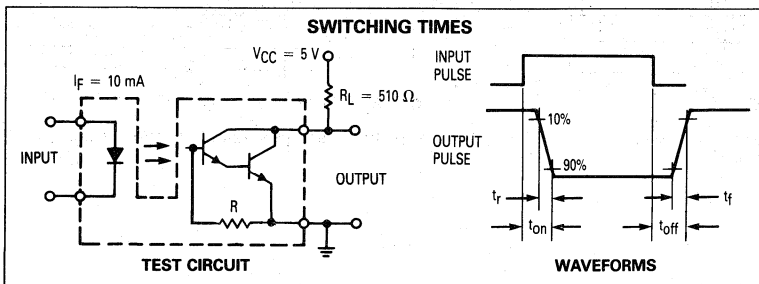

MOC71 Series

*MOC71T1 and MOC71U1
 are Motorola Preferred Devices

SLOTTED OPTICAL SWITCHES DARLINGTON OUTPUT

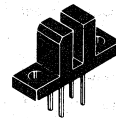

T
 CASE 354A-03
 STYLE 1

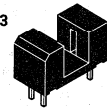

P
 CASE 354J-01
 STYLE 1



U
 CASE 354-03
 STYLE 1



V
 CASE 354G-02
 STYLE 1

8

PART NUMBER DERIVATION

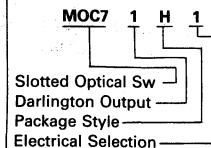

MOC71 Series

ELECTRICAL CHARACTERISTICS ($T_A = 25^\circ\text{C}$ unless otherwise noted. Note 1.)

Characteristic	Symbol	Min	Typ	Max	Unit
INPUT LED					
Forward Voltage ($I_F = 50\text{ mA}$)	V_F	0.9	1.3	1.8	Volts
Reverse Leakage ($V_R = 6\text{ V}$)	I_R	—	0.05	100	μA
Capacitance ($V = 0\text{ V}$, $f = 1\text{ MHz}$)	C_J	—	24	50	pF

OUTPUT DARLINGTON

Dark Current ($V_{CE} = 10\text{ V}$)	I_{CEO}	—	10	100	nA
Collector-Emitter Breakdown Voltage ($I_C = 1\text{ mA}$)	$V_{(BR)CEO}$	30	90	—	Volts
Capacitance ($V = 0\text{ V}$, $f = 1\text{ MHz}$)	C_{CE}	—	5.5	—	pF
DC Current Gain ($V_{CE} = 10\text{ V}$, $I_C = 2\text{ mA}$)	h_{FE}	—	10,000	—	—

COUPLED (Note 2)

Output Collector Current ($I_F = 5\text{ mA}$, $V_{CE} = 5\text{ V}$)	MOC71_1	I_C	2.5	5	—	mA
	MOC71_3		8	14	—	
Output Collector Current ($I_F = 10\text{ mA}$, $V_{CE} = 5\text{ V}$)	MOC71_1	I_C	7.5	15	—	mA
	MOC71_3		20	35	—	
Collector-Emitter Saturation Voltage ($I_C = 1.8\text{ mA}$, $I_F = 10\text{ mA}$)		$V_{CE(sat)}$	—	—	1	Volts
Turn-On Time ($I_F = 10\text{ mA}$, $V_{CC} = 5\text{ V}$, $R_L = 510\ \Omega$)		t_{on}	—	120	—	μs
Turn-Off Time ($I_F = 10\text{ mA}$, $V_{CC} = 5\text{ V}$, $R_L = 510\ \Omega$)		t_{off}	—	500	—	μs

- Notes: 1. Stray radiation can alter values of characteristics. Adequate light shielding should be provided.
2. No actuator in sensing gap.

8

TYPICAL CHARACTERISTICS

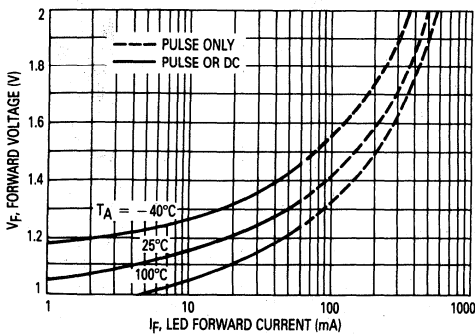

Figure 1. LED Forward Voltage versus Forward Current

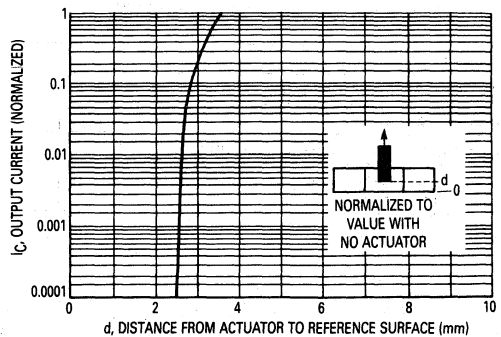

Figure 2. Output Current versus Actuator Position

MOC71 Series

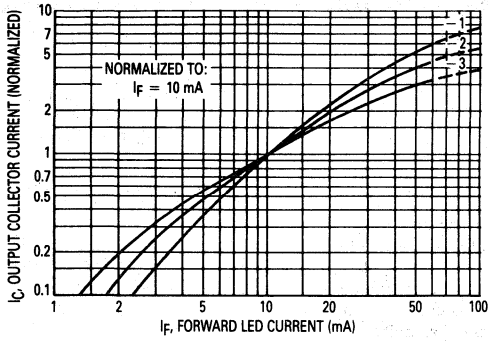

Figure 3. Output Current versus Input Current

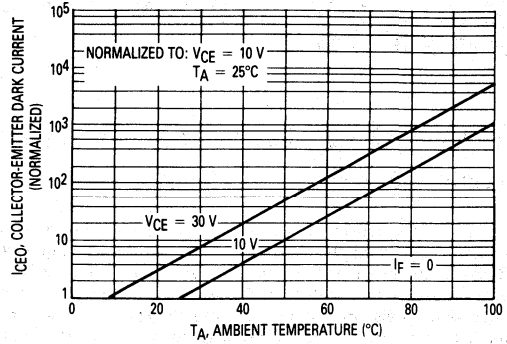

Figure 4. Collector-Emitter Dark Current versus Ambient Temperature

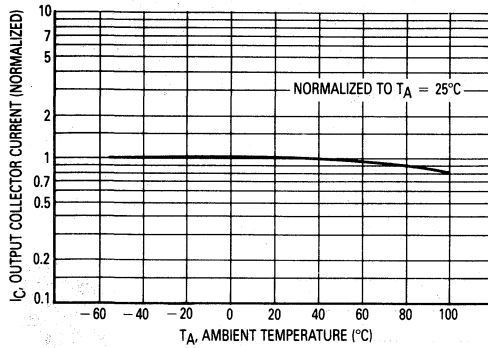

Figure 5. Output Current versus Ambient Temperature

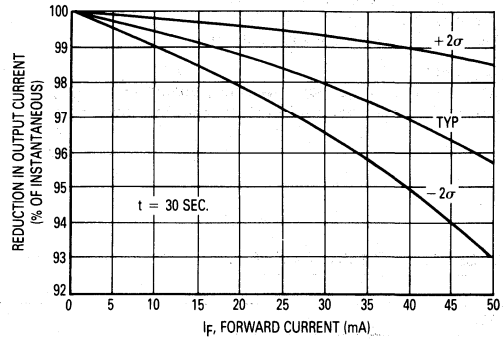

Figure 6. Reduction in Output Current Due to LED Heating versus Forward Current

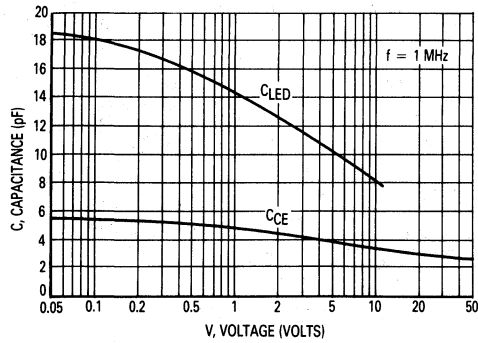

Figure 7. Capacitances versus Voltage

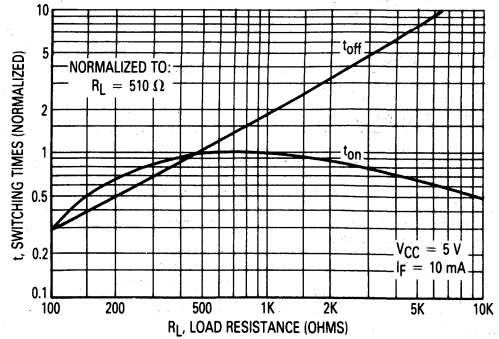

Figure 8. Switching Times versus Load Resistance

Slotted Optical Switches Logic Output

These devices consist of a GaAs LED facing a silicon, high-speed integrated circuit detector in a molded plastic housing. A slot in the housing between the emitter and the detector provides a means of mechanically interrupting the signal and switching the output from an on-state to an off-state. The detector incorporates a schmitt trigger which provides hysteresis for noise immunity and pulse shaping. The detector circuit is optimized for simplicity of operation and has an open-collector output for application flexibility.

Features:

- Single Unit for Easy PCB Mounting
- Non-Contact Logic Level Switching
- Long-Life Liquid Phase EPI Emitter
- 1 mm Detector Aperture Width
- Suitable for use in 3 V Applications

Applications:

Shaft encoders, non-contact switches, position sensing, paper handlers, coin handlers, and interruptive sensor application requiring logic level outputs.

ABSOLUTE MAXIMUM RATINGS: ($T_A = 25^\circ\text{C}$ unless otherwise noted)

Rating	Symbol	Value	Unit
INPUT LED			
Power Dissipation	P_D	100	mW
Forward Current (Continuous)	I_F	60	mA
Forward Current (Peak) (Pulse Width $\leq 1 \mu\text{s}$, PRR < 300 PPS)	I_F	1.5	A
Reverse Voltage	V_R	6	V
OUTPUT DETECTOR			
Output Voltage Range	V_O	0-16	V
Supply Voltage Range	V_{CC}	3-16	V
Output Current	I_O	50	mA
Power Dissipation	P_D	150*	mW
TOTAL DEVICE			
Storage Temperature	T_{stg}	-40°C to 100°C	°C
Operating Temperature	T_J	-40°C to 100°C	°C
Lead Soldering Temperature (5 seconds maximum)	T_L	260	°C

*Derate 2 mW/°C above 25°C ambient.

MOC75 Series

*MOC75T1 and MOC75U1
 are Motorola Preferred Devices

SLOTTED OPTICAL SWITCHES LOGIC OUTPUT

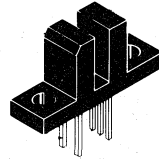

T
 CASE 354C-03
 STYLE 1



U
 CASE 354B-02
 STYLE 1

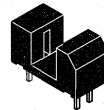

P
 CASE 354K-01
 STYLE 1

MOC75 Series

INDIVIDUAL ELECTRICAL CHARACTERISTICS (0–70°C) (See Note 1)

Characteristic	Symbol	Min	Typ	Max	Unit
INPUT LED					
Forward Voltage ($I_F = 20 \text{ mA}$)	V_F	—	1.1	1.6	V
Reverse Current ($V_R = 3 \text{ V}$)	I_R	—	—	10	μA
Reverse Breakdown Voltage ($I_R = 100 \mu\text{A}$)	$V_{(BR)R}$	6	—	—	V
Capacitance ($V = 0 \text{ V}$, $f = 1 \text{ MHz}$)	C	—	24	50	pF

OUTPUT DETECTOR

Operating Voltage	V_{CC}	3	—	15	V
Supply Current ($I_F = 0$, $V_{CC} = 5 \text{ V}$)	$I_{CC(\text{off})}$	—	1.3	5	mA
Output Current, High ($I_F = 0$, $V_{CC} = V_O = 15 \text{ V}$)	I_{OH}	—	—	100	μA

COUPLED (0–70°C) (See Note 1)

Threshold Current, ON ($R_L = 270 \Omega$, $V_{CC} = 5 \text{ V}$)	MOC75(T,U,P)1 MOC75(T,U,P)2	$I_{F(\text{on})}$	— —	20 10	30 15	mA
Threshold Current, OFF ($R_L = 270 \Omega$, $V_{CC} = 5 \text{ V}$)	MOC75(T,U,P)1 MOC75(T,U,P)2	$I_{F(\text{off})}$	0.5 0.5	15 8	— —	mA
Hysteresis Ratio ($R_L = 270 \Omega$, $V_{CC} = 5 \text{ V}$)		$\frac{I_{F(\text{off})}}{I_{F(\text{on})}}$	—	0.75	—	—
Supply Current ($I_F = I_{F(\text{on})}$, $V_{CC} = 5 \text{ V}$)		$I_{CC(\text{on})}$	—	3	5	mA
Output Voltage, Low ($I_F = I_{F(\text{on})}$, $V_{CC} = 5 \text{ V}$, $R_L = 270 \Omega$)		V_{OL}	—	0.2	0.4	V
Turn-On Time	$R_L = 270 \Omega$, $V_{CC} = 5 \text{ V}$, $I_F = I_{F(\text{on})}$, $T_A = 25^\circ\text{C}$	t_{on}	—	1.2	—	μs
Fall Time		t_f	—	0.1	—	
Turn-Off Time		t_{off}	—	1.2	—	
Rise Time		t_r	—	0.1	—	

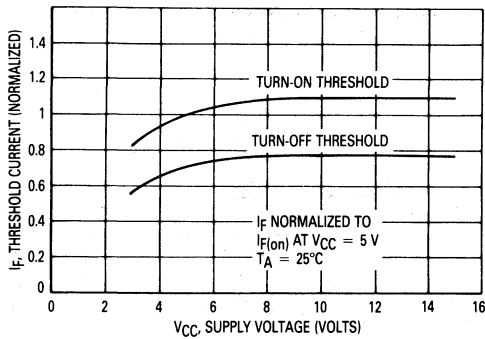

Figure 1. Normalized Threshold Current versus Supply Voltage

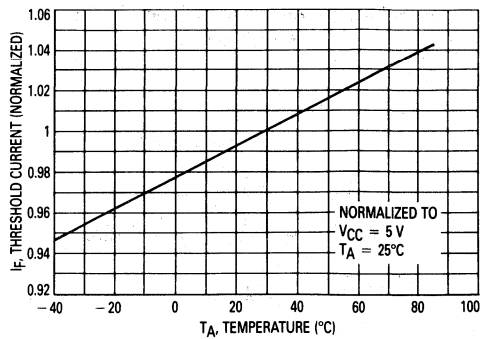

Figure 2. Threshold Current versus Temperature

MOC75 Series

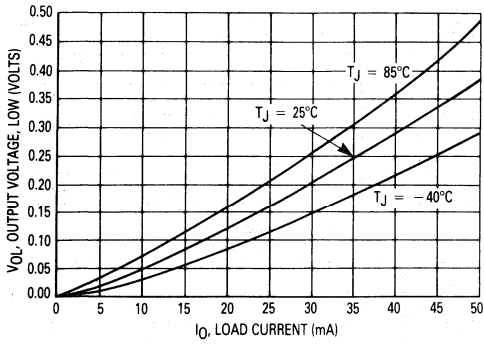

Figure 3. Output Voltage versus Load Current

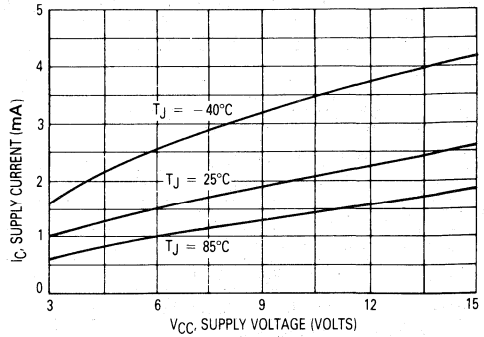

Figure 4. Supply Current versus Supply Voltage — Output High

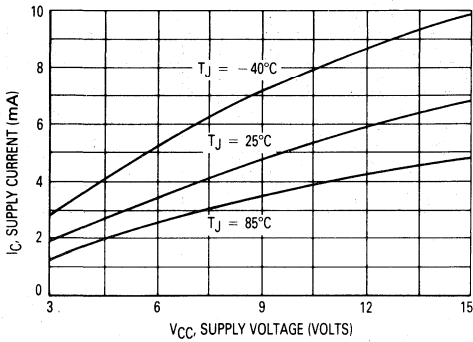

Figure 5. Supply Current versus Supply Voltage — Output Low

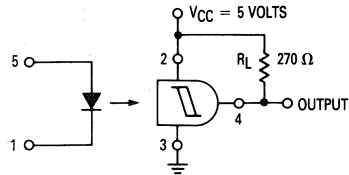

Figure 6. Test Circuit for Threshold Current Measurements

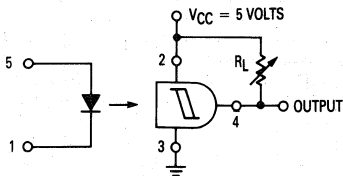

Figure 7. Test Circuit for Output Voltage versus Load Current Measurements

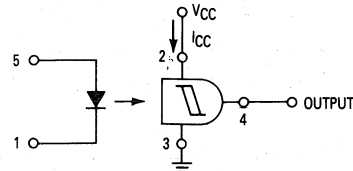

Figure 8. Test Circuit for Supply Current versus Supply Voltage Measurements

8

MOC75 Series

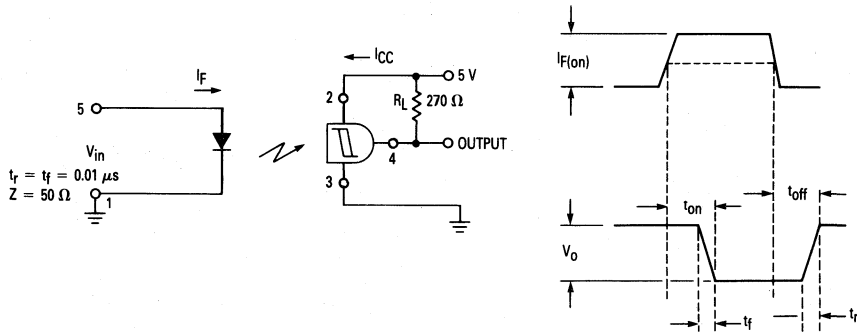
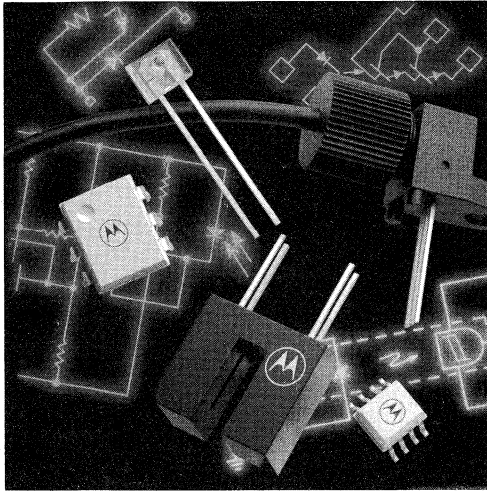

Figure 9. Switching Test Circuit



Section Nine

Fiber Optics

MFOD71	9-2
MFOD72	9-5
MFOD73	9-8
MFOD75	9-11
MFOD1100	9-15
MFOD2404	9-17
MFOD2405	9-19
MFOE71	9-21
MFOE76	9-23
MFOE1100 Series	9-26
MFOE1200	9-30
MFOE1201 Series	9-32

Fiber Optics — FLCS Family

Photo Detector

Diode Output

The MFOD71 is designed for low cost, short distance Fiber Optic Systems using 1000 micron core plastic fiber.

Features:

- Fast PIN Photodiode: Response Time < 5 ns
- Ideally Matched to MFOE76 Emitter for Plastic Fiber Systems
- Annular Passivated Structure for Stability and Reliability
- FLCS Package
 - Includes Connector
 - Simple Fiber Termination and Connection (Figure 4)
 - Easy Board Mounting
 - Molded Lens for Efficient Coupling
 - Mates with 1000 Micron Core Plastic Fiber (Eska SH4001)

Applications:

- Medical Electronics
- Industrial Controls
- Security Systems
- Short Haul Communication Systems
- High Isolation Interconnects
- M6800 Microprocessor Systems

MFOD71

**FLCS FAMILY
 FIBER OPTICS
 PHOTO DETECTOR
 DIODE OUTPUT**

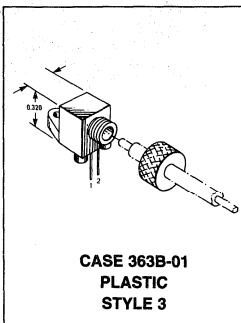

MAXIMUM RATINGS ($T_A = 25^\circ\text{C}$ unless otherwise noted)

Rating	Symbol	Value	Unit
Reverse Voltage	MFOD71 V_R	100	Volts
Total Power Dissipation @ $T_A = 25^\circ\text{C}$ Derate above 25°C	P_D	150 2	mW mW/°C
Operating and Storage Junction Temperature Range	T_J, T_{stg}	-40 to +100	°C

ELECTRICAL CHARACTERISTICS ($T_A = 25^\circ\text{C}$ unless otherwise noted)

Characteristic	Symbol	Min	Typ	Max	Unit
Dark Current ($V_R = 20\text{ V}, R_L = 1\text{ M}\Omega$) $T_A = 25^\circ\text{C}$ $T_A = 85^\circ\text{C}$	I_D	—	0.06 10	10 —	nA
Reverse Breakdown Voltage ($I_R = 10\ \mu\text{A}$)	$V_{(BR)R}$	50	100	—	Volts
Forward Voltage ($I_F = 50\text{ mA}$)	V_F	—	—	1.1	Volts
Series Resistance ($I_F = 50\text{ mA}$)	R_S	—	8	—	Ohms
Total Capacitance ($V_R = 20\text{ V}, f = 1\text{ MHz}$)	C_T	—	3	—	pF

OPTICAL CHARACTERISTICS ($T_A = 25^\circ\text{C}$)

Characteristic	Symbol	Min	Typ	Max	Unit
Responsivity ($V_R = 5\text{ V}$, Figure 2)	R	0.15	0.2	—	$\mu\text{A}/\mu\text{W}$
Response Time ($V_R = 5\text{ V}, R_L = 50\ \Omega$)	$t(\text{resp})$	—	5	—	ns

9

MFOD71

TYPICAL COUPLED CHARACTERISTICS

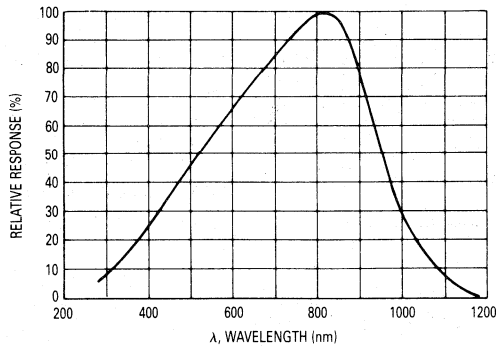

Figure 1. Relative Spectral Response

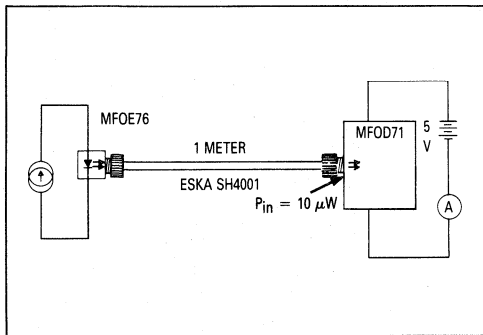

Figure 2. Responsivity Test Configuration

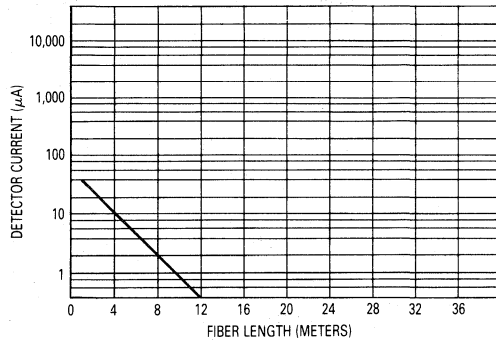

Figure 3. Detector Current versus Fiber Length

The system length achieved with a MFOE76 emitter and various detectors, using 1000 micron core plastic fiber (Eska SH4001 or equivalent), depends on the LED forward

current (I_f) and the responsivity of the detector chosen. Each detector will perform with the MFOE76 up to the distances shown below.

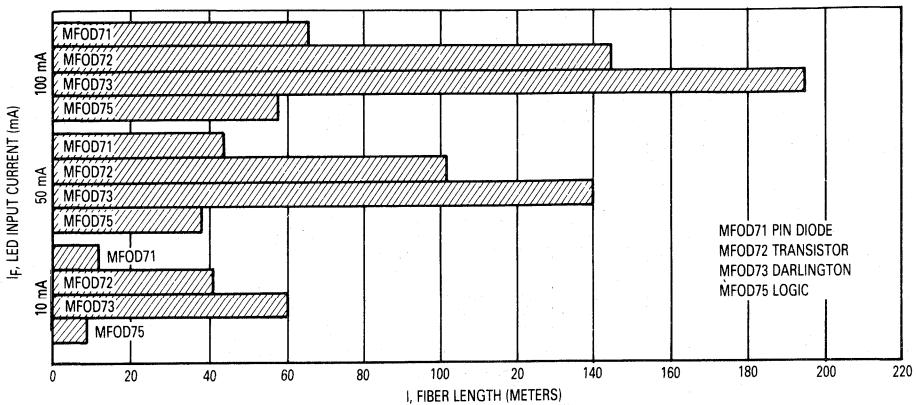

Figure 4. MFOE76 Working Distances

MFOD71

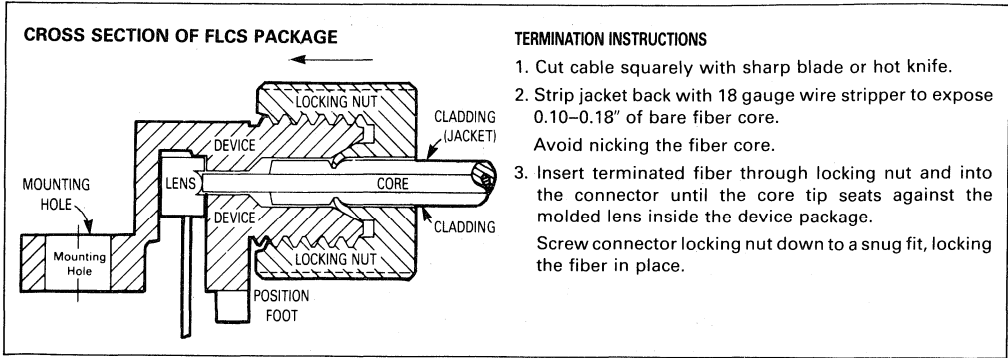

Figure 5. FO Cable Termination and Assembly

INPUT SIGNAL CONDITIONING

The following circuits are suggested to provide the desired forward current through the emitter.

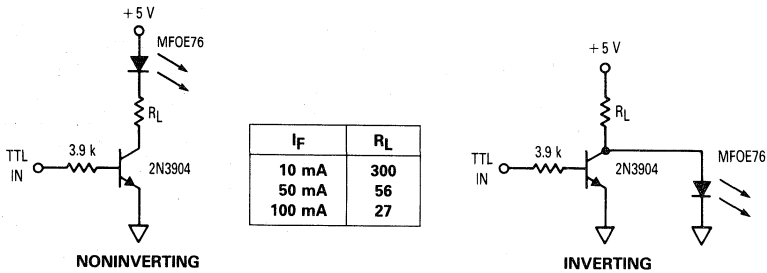

Figure 6. TTL Transmitters

OUTPUT SIGNAL CONDITIONING

The following circuit is suggested to take the MFOD71 detector output and condition it to drive TTL with an acceptable bit error rate.

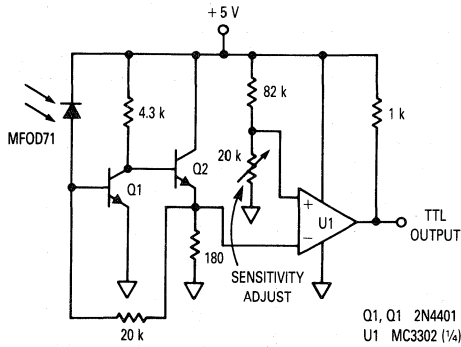

Figure 7. TTL Receiver

Fiber Optics — FLCS Family

Photo Detector

Transistor Output

MFOD72

Motorola Preferred Device

FLCS FAMILY
FIBER OPTICS
PHOTO DETECTOR
TRANSISTOR OUTPUT

The MFOD72 is designed for low cost, short distance Fiber Optic Systems using 1000 micron core plastic fiber.

Features:

- Standard Phototransistor Output
- Ideally Matched to MFOE76 Emitter for Plastic Fiber Systems
- Annular Passivated Structure for Stability and Reliability
- FLCS Package
 - Includes Connector
 - Simple Fiber Termination and Connection (Figure 4)
 - Easy Board Mounting
 - Molded Lens for Efficient Coupling
 - Mates with 1000 Micron Core Plastic Fiber (Eska SH4001)

Applications:

- Medical Electronics
- Industrial Controls
- Security Systems
- Short Haul Communication Systems
- High Isolation Interconnects
- M6800 Microprocessor Systems

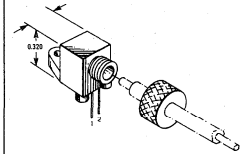

CASE 363B-01
PLASTIC
STYLE 3

MAXIMUM RATINGS ($T_A = 25^\circ\text{C}$ unless otherwise noted)

Rating	Symbol	Value	Unit
Collector-Emitter Voltage	V_{CEO}	30	Volts
Total Power Dissipation ($\alpha T_A = 25^\circ\text{C}$ Derate above 25°C)	P_D	150 2	mW mW/ $^\circ\text{C}$
Operating and Storage Junction Temperature Range	T_J, T_{stg}	-40 to +100	$^\circ\text{C}$

ELECTRICAL CHARACTERISTICS ($T_A = 25^\circ\text{C}$ unless otherwise noted)

Characteristic	Symbol	Min	Typ	Max	Unit
Collector Dark Current ($V_{CE} = 10\text{ V}$)	I_D	—	—	100	nA
Collector-Emitter Breakdown Voltage ($I_C = 10\text{ mA}$)	$V_{(BR)CEO}$	30	—	—	Volts

OPTICAL CHARACTERISTICS

Responsivity ($V_{CC} = 5\text{ V}$, Figure 2)	R	80	125	—	$\mu\text{A}/\mu\text{W}$
Saturation Voltage ($\lambda = 850\text{ nm}$, $V_{CC} = 5\text{ V}$ $P_{in} = 10\ \mu\text{W}$, $I_C = 1\text{ mA}$)	$V_{CE(sat)}$	—	0.25	0.4	Volts
Turn-On Time Turn-Off Time	$R_L = 2.4\text{ k}\Omega$, $P_{in} = 10\ \mu\text{W}$, $\lambda = 850\text{ nm}$, $V_{CC} = 5\text{ V}$	t_{on}	—	10	μs
		t_{off}	—	60	μs

Preferred devices are Motorola recommended choices for future use and best overall value.

MFOD72

TYPICAL COUPLED CHARACTERISTICS

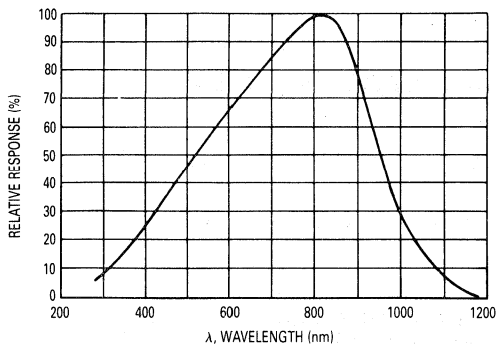

Figure 1. Relative Spectral Response

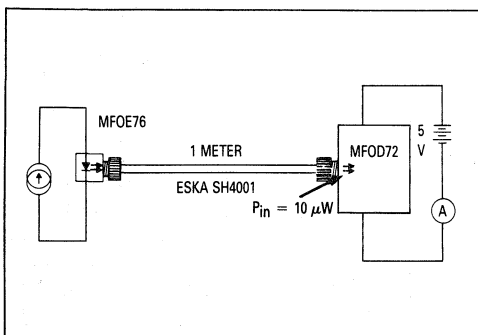

Figure 2. Responsivity Test Configuration

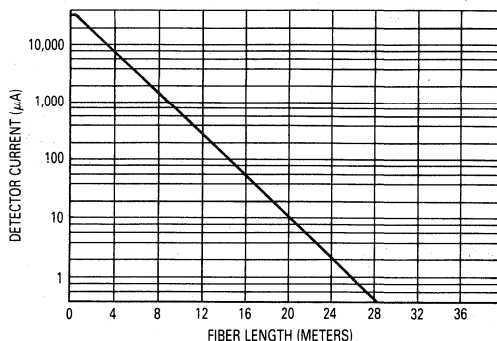

Figure 3. Detector Current versus Fiber Length

The system length achieved with a MFOE76 emitter and various detectors, using 1000 micron core plastic fiber (Eska SH4001 or equivalent), depends on the LED forward

current (I_f) and the responsivity of the detector chosen. Each detector will perform with the MFOE76 up to the distances shown below.

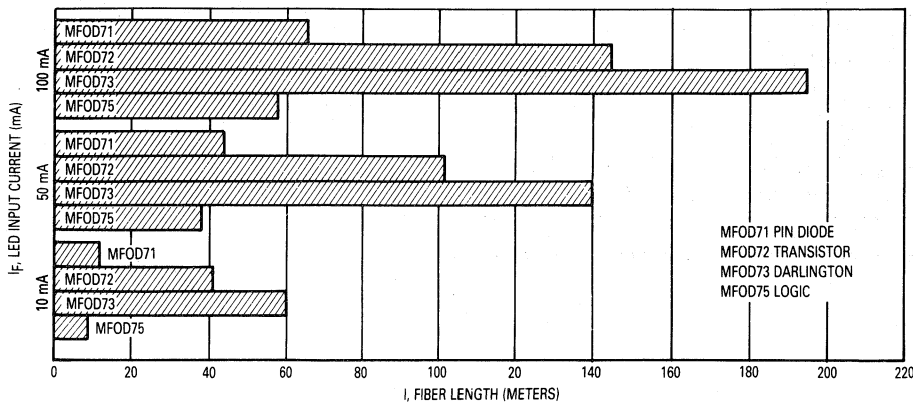

Figure 4. MFOE76 Working Distances

MFOD72

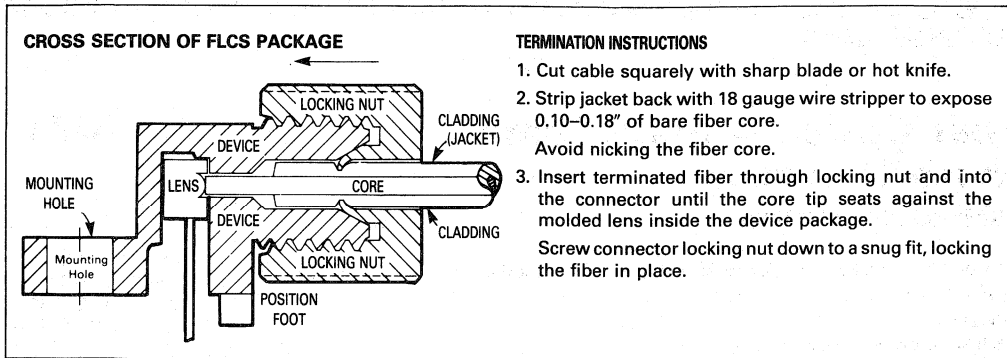

Figure 5. FO Cable Termination and Assembly

INPUT SIGNAL CONDITIONING

The following circuits are suggested to provide the desired forward current through the emitter.

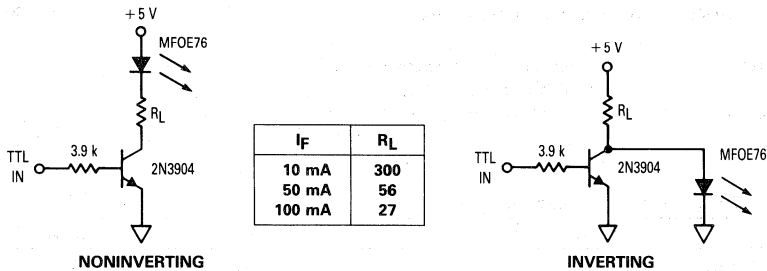

Figure 6. TTL Transmitters

OUTPUT SIGNAL CONDITIONING

The following circuit is suggested to take the MFOD72 detector output and condition it to drive TTL with an acceptable bit error rate.

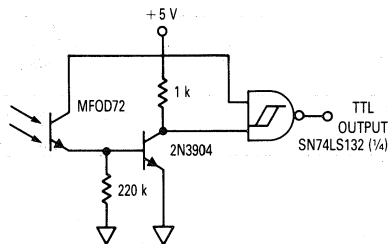

Figure 7. 5 kHz Transistor Receiver

Fiber Optics — FLCS Family

Photo Detector

Darlington Output

MFOD73

**FLCS FAMILY
 FIBER OPTICS
 PHOTO DETECTOR
 DARLINGTON OUTPUT**

The MFOD73 is designed for low cost, short distance Fiber Optic Systems using 1000 micron core plastic fiber.

Features:

- High Sensitivity Photodarlington Output
- Ideally Matched to MFOE76 Emitter for Plastic Fiber Systems
- Annular Passivated Structure for Stability and Reliability
- FLCS Package
 - Includes Connector
 - Simple Fiber Termination and Connection (Figure 4)
 - Easy Board Mounting
 - Molded Lens for Efficient Coupling
 - Mates with 1000 Micron Core Plastic Fiber (Eska SH4001)

Applications:

- Medical Electronics
- Industrial Controls
- Security Systems
- Short Haul Communication Systems
- High Isolation Interconnects
- M6800 Microprocessor Systems

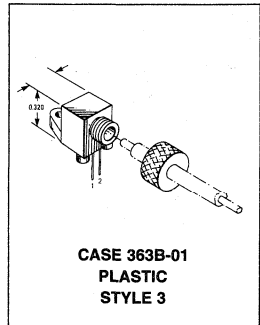

MAXIMUM RATINGS ($T_A = 25^\circ\text{C}$ unless otherwise noted)

Rating	Symbol	Value	Unit
Collector-Emitter Voltage	V_{CEO}	60	Volts
Total Power Dissipation @ $T_A = 25^\circ\text{C}$ Derate above 25°C	P_D	150 2	mW mW/ $^\circ\text{C}$
Operating and Storage Junction Temperature Range	T_J, T_{stg}	-40 to +100	$^\circ\text{C}$

ELECTRICAL CHARACTERISTICS ($T_A = 25^\circ\text{C}$ unless otherwise noted)

Characteristic	Symbol	Min	Typ	Max	Unit
Collector Dark Current ($V_{CE} = 10\text{ V}$)	I_D	—	—	100	nA
Collector-Emitter Breakdown Voltage ($I_C = 10\text{ mA}$)	$V_{(BR)CEO}$	60	—	—	Volts

OPTICAL CHARACTERISTICS

Responsivity ($V_{CC} = 5\text{ V}$, Figure 2)	R	1,000	1,500	—	$\mu\text{A}/\mu\text{W}$
Saturation Voltage ($\lambda = 850\text{ nm}$, $V_{CC} = 5\text{ V}$) ($P_{in} = 1\ \mu\text{W}$, $I_C = 2\text{ mA}$)	$V_{CE(sat)}$	—	0.75	1	Volts
Turn-On Time	$R_L = 100\ \Omega$, $P_{in} = 1\ \mu\text{W}$, $\lambda = 850\text{ nm}$, $V_{CC} = 5\text{ V}$	t_{on}	—	125	μs
Turn-Off Time		t_{off}	—	150	μs

9

MFOD73

TYPICAL COUPLED CHARACTERISTICS

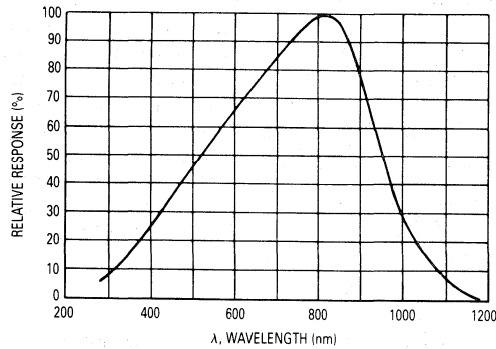

Figure 1. Relative Spectral Response

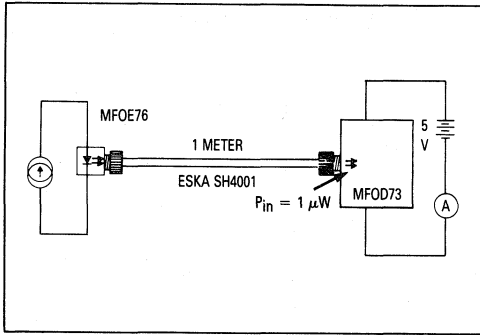

Figure 2. Responsivity Test Configuration

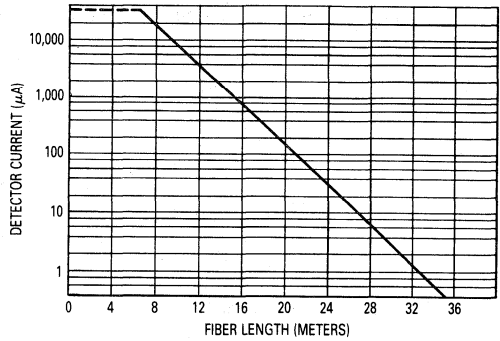

Figure 3. Detector Current versus Fiber Length

The system length achieved with a MFOE76 emitter and various detectors, using 1000 micron core plastic fiber (Eska SH4001 or equivalent), depends on the LED forward

current (I_F) and the responsivity of the detector chosen. Each detector will perform with the MFOE76 up to the distances shown below.

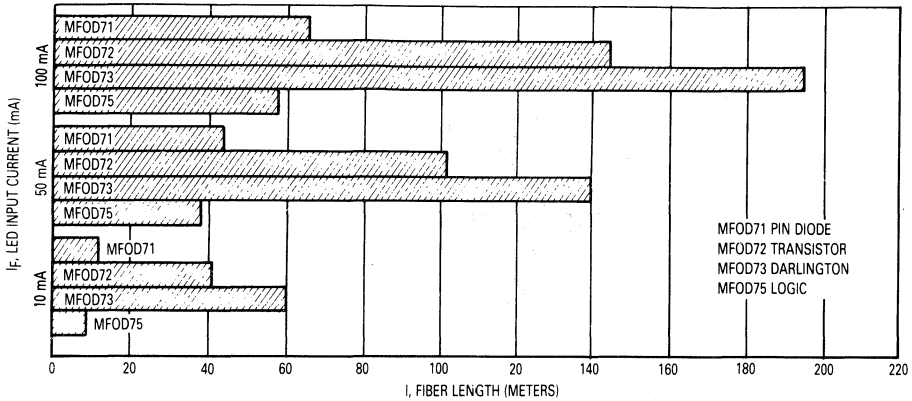

Figure 4. MFOE76 Working Distances

MFOD73

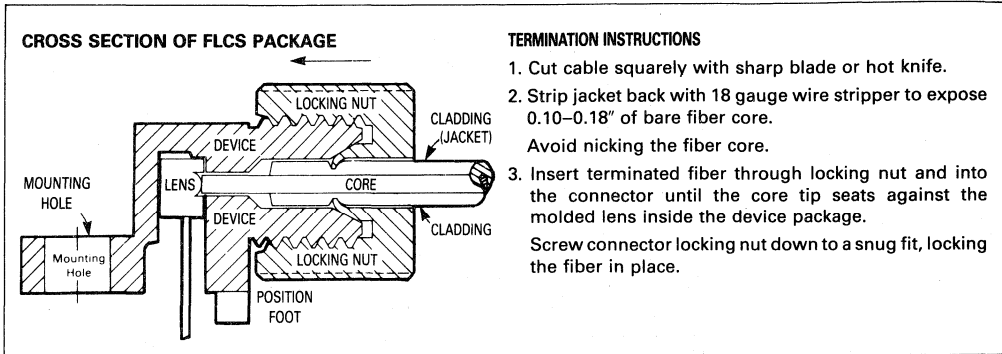

Figure 5. FO Cable Termination and Assembly

INPUT SIGNAL CONDITIONING

The following circuits are suggested to provide the desired forward current through the emitter.

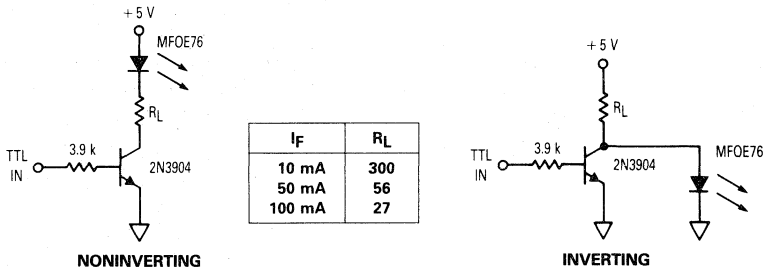

Figure 6. TTL Transmitters

OUTPUT SIGNAL CONDITIONING

The following circuit is suggested to take the FLCS detector output and condition it to drive TTL with an acceptable bit error rate.

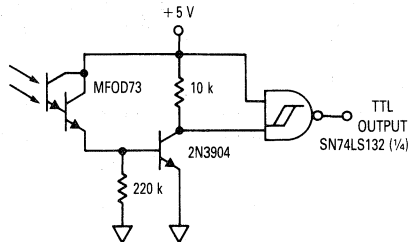

Figure 7. 1 kHz Darlington Receiver

Fiber Optics — FLCS Family

Photo Detector

Logic Output

MFOD75

**FLCS FAMILY
 FIBER OPTICS
 PHOTO DETECTOR
 LOGIC OUTPUT**

The MFOD75 is designed for low cost, short distance (< 60 m) fiber optics systems using 1000 micron (1 mm) plastic core fiber.

Features:

- Ideally Matched to MFOE76 Emitter For Plastic Fiber Systems
- Connector Included
- Simple Fiber Termination and Connection (Figure 12)
- Easy Board Mounting
- Molded Lens for Efficient Coupling
- Designed for 1000 Micron Core Plastic Fiber, Such As:
 Eska SH4001

Applications:

- Medical Electronics
- Industrial Controls
- Security Systems
- Short Haul Communication Systems
- High Isolation Interconnects
- M6800 Microprocessor Systems

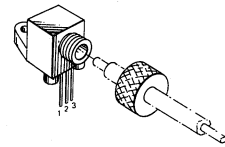

**CASE 363C-01
 PLASTIC
 STYLE 1**

MAXIMUM RATINGS ($T_A = 25^\circ\text{C}$ unless otherwise noted)

Rating	Symbol	Value	Unit
Supply Voltage Range	V_{CC}	3-16	Volts
Output Current	I_o	50	mA
Power Dissipation* Derate above 25°C	P_D ΔP_D	150 2	mW mW/ $^\circ\text{C}$
Operating and Junction Temperature Range	T_A, T_J	-40 to +85	$^\circ\text{C}$
Storage Temperature Range	T_{stg}	-40 to +100	$^\circ\text{C}$
Soldering Temperature (5 seconds)	—	260	$^\circ\text{C}$

DEVICE CHARACTERISTICS ($T_A = 25^\circ\text{C}$)

Characteristic	Symbol	Min	Typ	Max	Unit
Supply Current with Output High ($I_F = 0, V_{CC} = 5\text{ V}$)	$I_{CC(off)}$	—	1.3	5	mA
Output Current with Output High ($I_F = 0, V_{CC} = 15\text{ V}, R_L = 270\ \Omega$)	I_{OH}	—	—	100	nA
Supply Current with Output Low ($I_F = I_{F(on)}, V_{CC} = 5\text{ V}$)	$I_{CC(on)}$	—	3	5	mA
Output Voltage, Low ($I_F = I_{F(on)}, V_{CC} = 5\text{ V}, R_L = 270\ \Omega$)	V_{OL}	—	0.14	0.4	Volts
Light Required to Trigger ($V_{CC} = 5\text{ V}, R_L = 270\ \Omega, \lambda = 850\text{ nm}$)	$H_{(on)}$	—	6	10	μW
Hysteresis Ratio ($V_{CC} = 5\text{ V}, R_L = 270\ \Omega$)	$\frac{H_{(on)}}{H_{(off)}}$	—	0.75	—	—
Turn-On Time	t_{on}	—	0.4	2	μs
Fall Time	t_f	—	20	—	ns
Turn-Off Time	t_{off}	—	0.8	2	μs
Rise Time	t_r	—	40	—	ns

$V_{CC} = 5\text{ V}, R_L = 270\ \Omega,$
 $H = 20\ \mu\text{W},$ Figure 2,
 @ 850 nm

*Measured with device soldered into typical printed circuit board.

MFOD75

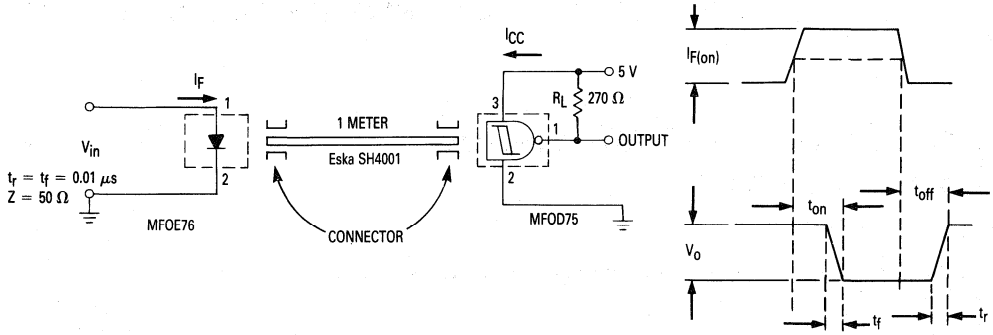

Figure 1. Switching Test Circuit

TYPICAL CHARACTERISTICS

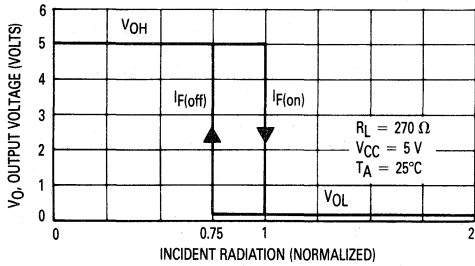

Figure 2. Transfer Characteristics

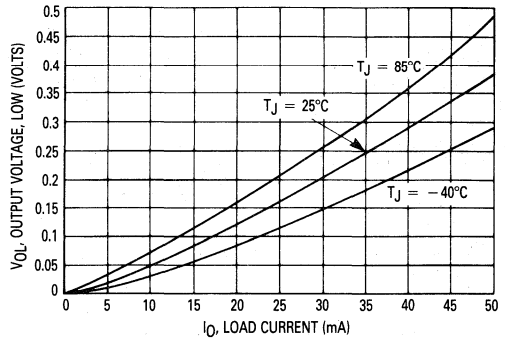

Figure 3. Output Voltage, Low versus Load Current

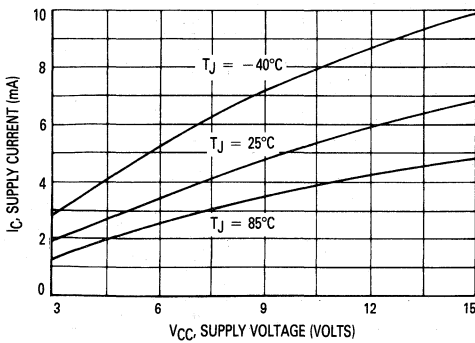

Figure 4. Supply Current versus Supply Voltage — Output Low

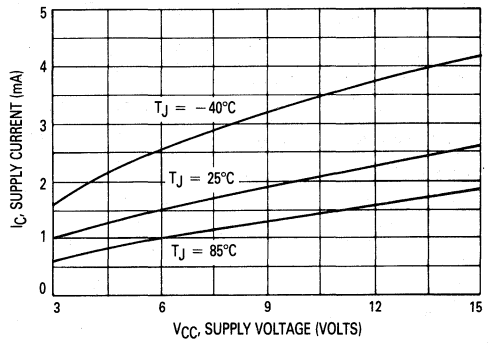

Figure 5. Supply Current versus Supply Voltage — Output High

MFOD75

TYPICAL CHARACTERISTICS

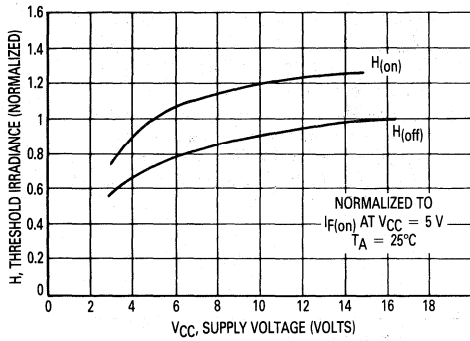

Figure 6. Threshold Irradiance versus Supply Voltage

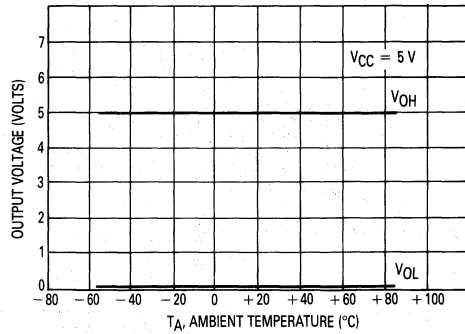

Figure 7. Output Voltage versus Ambient Temperature

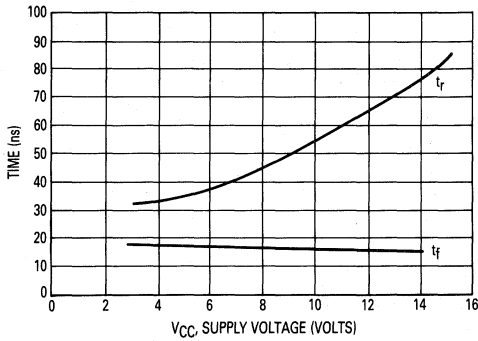

Figure 8. Pulse Response Time versus Supply Voltage

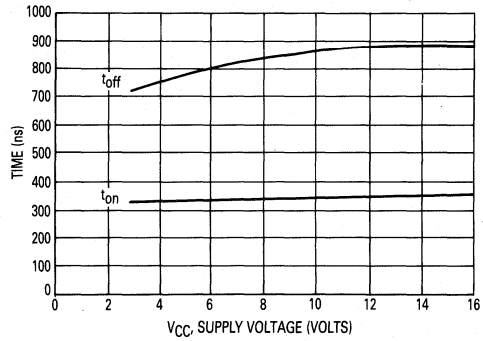
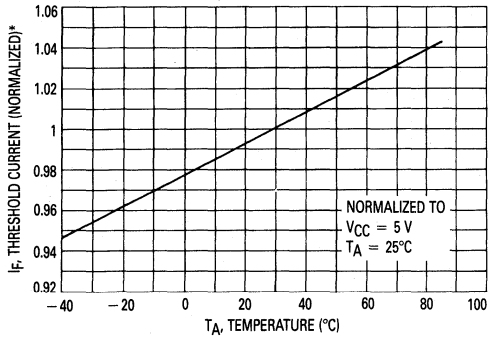

Figure 9. Total Switching Time versus Supply Voltage

Typical Coupled Characteristics Using MFOE71 and 1 Meter 1000 μ m Plastic Cable



(*Temperature effects on plastic cable not included)

Figure 10. Threshold Current versus Temperature

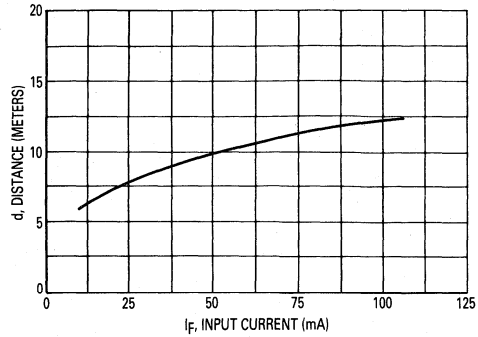

Figure 11. Working Distance versus Input Current

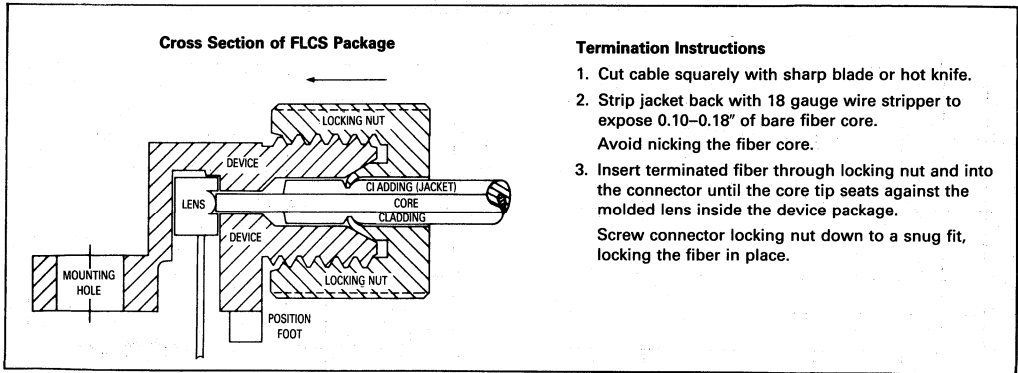

Figure 12. FO Cable Termination and Assembly

Fiber Optics — High Performance Family Photo Detector Diode Output

The MFOD1100 is designed for infrared radiation detection in high frequency Fiber Optics Systems. It is packaged in Motorola's hermetic TO-206AC (TO-52) case, and it fits directly into standard fiber optics connectors. The metal connectors provide excellent RFI immunity.

Features:

- Fast Response — 1 ns Max @ 5 Volts
- Analog Bandwidth (–3 dB) Greater Than 250 MHz
- Performance Matched to Motorola Fiber Optics Emitters
- TO-206AC (TO-52) Package — Small, Rugged, and Hermetic
- Compatible with AMP #228756-1, Amphenol #905-138-5001 and Radiall #F086600380 Receptacles Using Motorola Plastic Alignment Bushing MFOA06 (Included)

Applications:

- Medical Electronics
- Security Systems
- CATV
- Computer and Peripheral Equipment
- Industrial Controls
- M6800 Microprocessor Systems
- Video Systems
- Communication Systems

MAXIMUM RATINGS ($T_A = 25^\circ\text{C}$ unless otherwise noted)

Rating	Symbol	Value	Unit
Reverse Voltage	V_R	50	Volts
Total Device Dissipation @ $T_A = 25^\circ\text{C}$ Derate above 25°C	P_D	50 0.5	mW mW/ $^\circ\text{C}$
Operating Temperature Range	T_A	–55 to +125	$^\circ\text{C}$
Storage Temperature Range	T_{stg}	–65 to +150	$^\circ\text{C}$

ELECTRICAL CHARACTERISTICS ($T_A = 25^\circ\text{C}$)

Characteristic	Symbol	Min	Typ	Max	Unit
Dark Current ($V_R = 5\text{ V}$, $R_L = 1\text{ M}$, $H = 0$, Figure 2)	I_D	—	—	1	nA
Reverse Breakdown Voltage ($I_R = 10\ \mu\text{A}$)	$V_{(BR)R}$	50	—	—	Volts
Forward Voltage ($I_F = 50\text{ mA}$)	V_F	—	2	2.5	Volts
Total Capacitance ($V_R = 5\text{ V}$, $f = 1\text{ MHz}$)	C_T	—	—	2.5	pF
Noise Equivalent Power	NEP	—	50	—	fW/ $\sqrt{\text{Hz}}$

OPTICAL CHARACTERISTICS ($T_A = 25^\circ\text{C}$)

Responsivity @ 850 nm ($V_R = 5\text{ V}$, $P = 10\ \mu\text{W}$, Figure 3, 5)	R	0.3	0.35	—	$\mu\text{A}/\mu\text{W}$
Response Time @ 850 nm ($V_R = 20\text{ V}$)	t_r, t_f	—	1.2	3	ns
Effective Input Port Diameter (Figure 4)	—	—	300 0.012	—	Microns Inches
10 dB (90%) Numerical Aperture of Input Port (Figure 4)	NA	—	0.4	—	—

MFOD1100

**HERMETIC FAMILY
 FIBER OPTICS
 PHOTO DETECTOR
 DIODE OUTPUT**

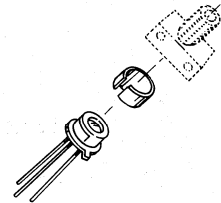

**CASE 210A-01
 METAL
 STYLE 1**

MFOD1100

TYPICAL CHARACTERISTICS

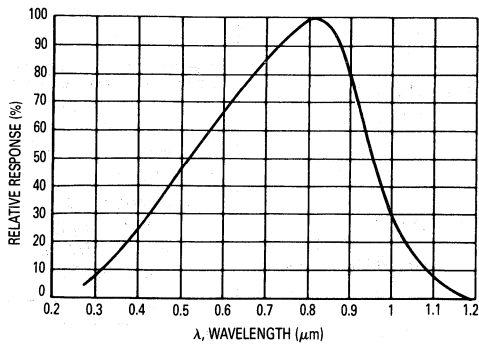

Figure 1. Relative Spectral Response

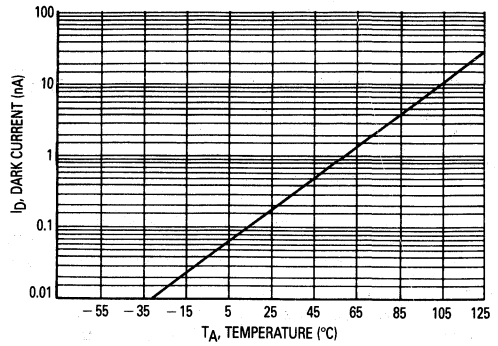

Figure 2. Dark Current versus Temperature

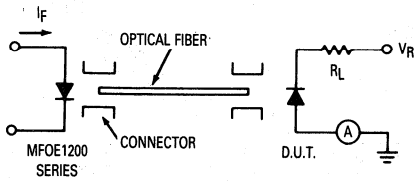

Figure 3. Responsivity Test Configuration

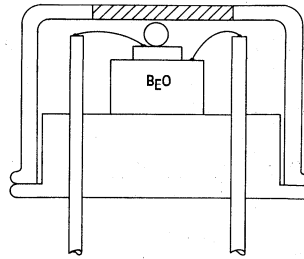

Figure 4. Package Cross Section

Fiber Optics — High Performance Family

Photo Detector

Preamplifier Output

MFOD2404

**HERMETIC FAMILY
 FIBER OPTICS
 PHOTO DETECTOR
 PREAMPLIFIER OUTPUT**

The MFOD2404 is designed as a monolithic integrated circuit containing both detector and preamplifier for use in medium bandwidth, medium distance systems. It is packaged in Motorola's hermetic TO-206AC (TO-52) case, and fits directly into standard fiber optics connectors which also provide excellent RFI immunity. The output of the device is low impedance to provide even less sensitivity to stray interference. The MFOD2404 has a 300 μm (12 mil) optical spot with a high numerical aperture.

Features:

- Usable for Data Systems Up to 10 Megabaud
- Dynamic Range Greater than 100:1
- Compatible with AMP #228756-1, Amphenol #905-138-5001 Receptacles Using Motorola Alignment Bushing MFOA06 (Included)
- Performance Matched to Motorola Fiber Optics Emitter
- TO-206AC (TO-52) Package — Small, Rugged and Hermetic
- 300 μm (12 mil) Diameter Optical Spot

Applications:

- Medical Electronics
- Security Systems
- Computer and Peripheral Equipment
- Industrial Controls
- M6800 Microprocessor Systems
- Communication Systems

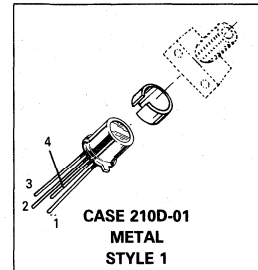

MAXIMUM RATINGS

Rating	Symbol	Value	Unit
Supply Voltage	V_{CC}	7.5	Volts
Operating Temperature Range	T_A	-55 to +125	$^{\circ}\text{C}$
Storage Temperature Range	T_{stg}	-65 to +150	$^{\circ}\text{C}$

ELECTRICAL CHARACTERISTICS ($V_{CC} = 5\text{ V}$, $T_A = 25^{\circ}\text{C}$)

Characteristic	Symbol	Conditions	Min	Typ	Max	Units
Power Supply Current	I_{CC}	Circuit A	3	3.5	5	mA
Quiescent dc Output Voltage (Noninverting Output)	V_q	Circuit A	0.5	0.6	0.7	Volts
Quiescent dc Output Voltage (Inverting Output)	V_q	Circuit A	2.7	3	3.3	Volts
RMS Noise Output	V_{NO}	Circuit A	—	0.4	1	mV

OPTICAL CHARACTERISTICS

Responsivity ($V_{CC} = 5\text{ V}$, $P = 2\ \mu\text{W}$) (Note 1)	$\lambda = 940\text{ nm}$ $\lambda = 850\text{ nm}$	R	Circuit B	20 23	30 35	50 58	$\text{mV}/\mu\text{W}$
Sensitivity (10 Mb/s NRZ, BER = 10^{-9})		S		0.1	—	—	μW
Pulse Response		t_r, t_f	Circuit B	—	35	50	ns
Numerical Aperture of Input Port (300 μm [12 mil] diameter spot)		NA		—	0.5	—	—
Signal-to-Noise Ratio @ $P_{in} = 1\ \mu\text{W}$ peak (Note 2)		S/N		—	35	—	dB
Maximum Input Power for Negligible Distortion in Output Pulse ($V_{CC} = 5\text{ V}$, Note 2)				—	—	30	μW

RECOMMENDED OPERATING CONDITIONS

Supply Voltage	V_{CC}	4	5	6	Volts
Resistive Load (Either Output)	R_L	200	—	—	Ohms
Capacitive Load (Either Output)	C_L	—	—	100	pF
Input Wavelength	λ	—	850	—	nm

Notes: 1. As measured on either output (single-ended).
 2. Power launched into SMA type device receptacle.

MFOD2404

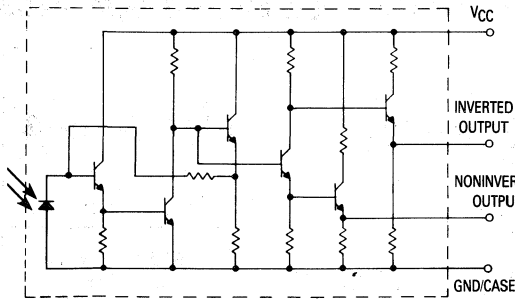

Figure 1. Equivalent Schematic

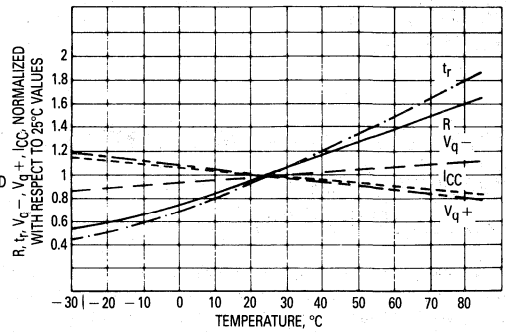
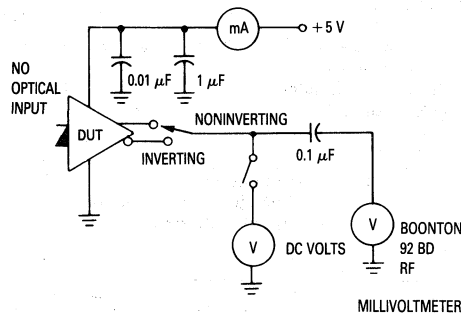
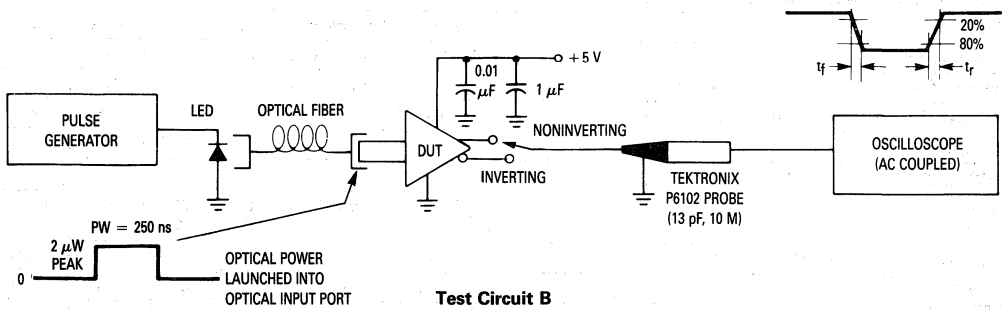

Figure 2. Typical Performance versus Temperature



Test Circuit A



Test Circuit B

Fiber Optics — High Performance Family

Photo Detector

Preamplifier Output

MFOD2405

**HERMETIC FAMILY
 FIBER OPTICS
 PHOTO DETECTOR
 PREAMPLIFIER OUTPUT**

The MFOD2405 is designed as a monolithic integrated circuit containing both detector and preamplifier.

Packaged in Motorola's hermetic TO-206AC (TO-52) case, the device fits directly into standard fiber optics connectors which also provide excellent RFI immunity. The output of the device is low impedance to provide even less sensitivity to stray interference. The MFOD2405 has a 300 μm (12 mil) optical spot with a high numerical aperture.

Features:

- Usable for Data Systems Through 40 Megabaud
- Dynamic Range Greater than 100:1
- Compatible with AMP #228756-1, Amphenol #905-138-5001 Receptacles Using Motorola Alignment Bushing #MFOA06 (Included)
- Performance Matched to Motorola Fiber Optics Emitter
- TO-206AC (TO-52) Package — Small, Rugged and Hermetic
- 300 μm (12 mil) Diameter Optical Spot

Applications:

- Medical Electronics
- Security Systems
- Computer and Peripheral Equipment
- Industrial Controls
- M6800 Microprocessor Systems
- Communication Systems

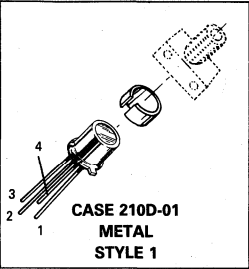

MAXIMUM RATINGS ($T_A = 25^\circ\text{C}$ unless otherwise noted)

Rating	Symbol	Value	Unit
Supply Voltage	V_{CC}	7.5	Volts
Operating Temperature Range	T_A	-55 to +125	$^\circ\text{C}$
Storage Temperature Range	T_{stg}	-65 to +150	$^\circ\text{C}$

ELECTRICAL CHARACTERISTICS ($V_{CC} = 5\text{ V}$, $T_A = 25^\circ\text{C}$)

Characteristic	Symbol	Conditions	Min	Typ	Max	Units
Power Supply Current	I_{CC}	Circuit A	3	4.5	6	mA
Quiescent dc Output Voltage (Noninverting Output)	V_q	Circuit A	0.6	0.7	0.8	Volts
Quiescent dc Output Voltage (Inverting Output)	V_q	Circuit A	2.7	3	3.3	Volts
RMS Noise Output	V_{NO}	Circuit A	—	0.5	1	mV

OPTICAL CHARACTERISTICS ($T_A = 25^\circ\text{C}$)

Responsivity ($V_{CC} = 5\text{ V}$, $\lambda = 850\text{ nm}$, $P = 10\ \mu\text{W}$, Note 1)	R	Circuit B	3	6	8	$\text{mV}/\mu\text{W}$
Sensitivity (40 Mb/s NRZ, BER = 10^{-9})	S		0.8	—	—	μW
Pulse Response	t_r, t_f	Circuit B	—	10	15	ns
Numerical Aperture of Input Port (300 μm [12 mil] diameter spot)	NA		—	0.5	—	—
Signal-to-Noise Ratio @ $P_{in} = 2\ \mu\text{W}$ peak (Note 2)	S/N		—	24	—	dB
Maximum Input Power for Negligible Distortion in Output Pulse ($V_{CC} = 5\text{ V}$, Note 2)		Circuit B	—	—	120	μW

RECOMMENDED OPERATING CONDITIONS

Supply Voltage	V_{CC}		4	5	6	Volts
Resistive Load (Either Output)	R_L		400	—	—	Ohms
Capacitive Load (Either Output)	C_L		—	—	100	pF
Input Wavelength	λ		—	850	—	nm

Notes: 1. As measured on either output (single-ended).
 2. Power launched into SMA type device receptacle.

MFOD2405

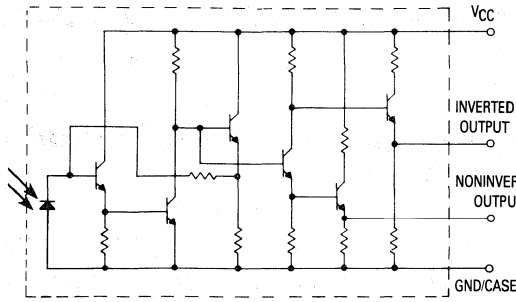

Figure 1. Equivalent Schematic

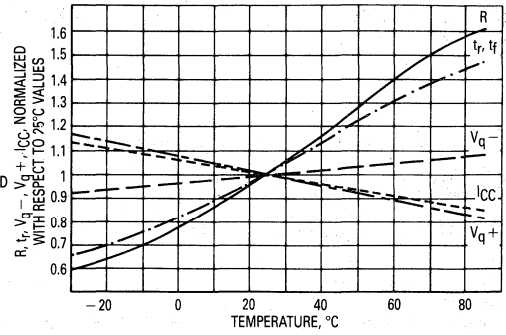
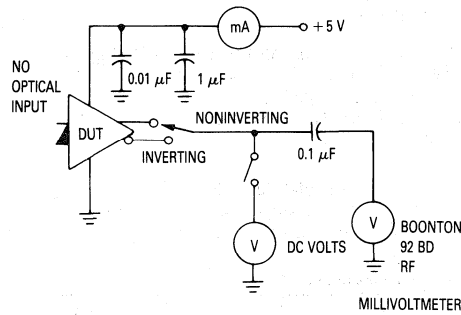
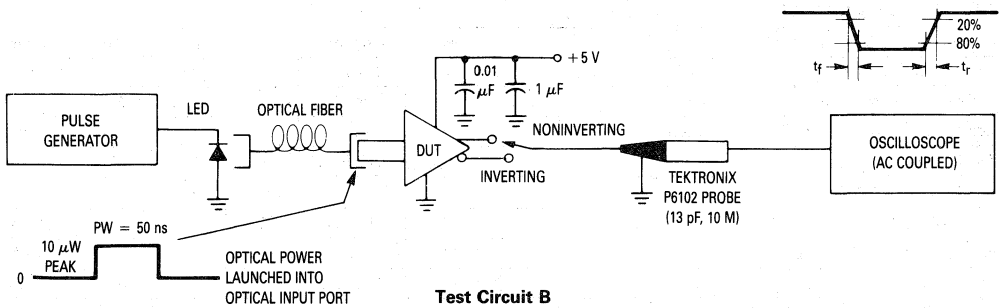

Figure 2. Typical Performance versus Temperature



Test Circuit A



Test Circuit B

9

Fiber Optics — FLCS Family Infrared LED

The MFOE71 is designed for low cost, medium frequency, short distance Fiber Optics Systems using 1000 micron core plastic fiber.

Features:

- Fast Response — > 10 MHz
- Spectral Response Matched to FLCS Detectors: MFOD71, 72, 73, 75
- FLCS Package
 - Low Cost
 - Includes Connector
 - Simple Fiber Termination and Connection
 - Easy Board Mounting
 - Molded Lens for Efficient Coupling
 - Mates with 1000 Micron Core Plastic Fiber (Eska SH4001)

Applications:

- Medical Electronics
- Industrial Controls
- Security Systems
- Short Haul Communication Systems
- High Isolation Interconnects
- M6800 Microprocessor Systems

MFOE71

**FLCS FAMILY
FIBER OPTICS
INFRARED LED
820 nm**

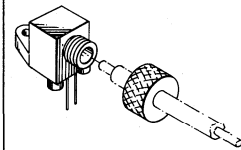

**CASE 363B-01
PLASTIC
STYLE 1**

MAXIMUM RATINGS

Rating	Symbol	Value	Unit
Reverse Voltage	V_R	6	Volts
Forward Current — Continuous	I_F	60	mA
— Peak Pulse		1	
Total Power Dissipation @ $T_A = 25^\circ\text{C}$ Derate above 25°C	$P_D(1)$	150	mW
		2	
Operating and Storage Junction Temperature Range	T_J, T_{stg}	-40 to +100	$^\circ\text{C}$
Lead Solder Temperature (5 sec. max; 1/16 inch from case)	—	260	$^\circ\text{C}$

(1) Measured with the device soldered into a typical printed circuit board.

ELECTRICAL CHARACTERISTICS ($T_A = 25^\circ\text{C}$ unless otherwise noted)

Characteristic	Fig. No.	Symbol	Min	Typ	Max	Unit
Reverse Breakdown Voltage ($I_R = 100 \mu\text{A}$)	—	$V_{(BR)R}$	2	4	—	Volts
Forward Voltage ($I_F = 100 \text{ mA}$)	—	V_F	—	1.5	2	Volts

OPTICAL CHARACTERISTICS ($T_A = 25^\circ\text{C}$ unless otherwise noted)

Characteristic	Fig. No.	Symbol	Min	Typ	Max	Unit
Power Launched ($I_F = 100 \text{ mA}$)	4, 5	P_L	110	165	—	μW
Optical Rise and Fall Time ($I_F = 100 \text{ mA}$) Figure 5	2	t_r, t_f	—	25	35	ns
Peak Wavelength ($I_F = 100 \text{ mA}$)	1	λ_P	—	820	—	nm

For simple fiber termination instructions, see the MFOD71, 72 and 73 data sheets.

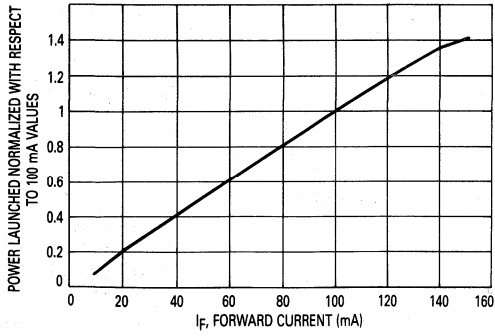

Figure 1. Normalized Power Launched versus Forward Current

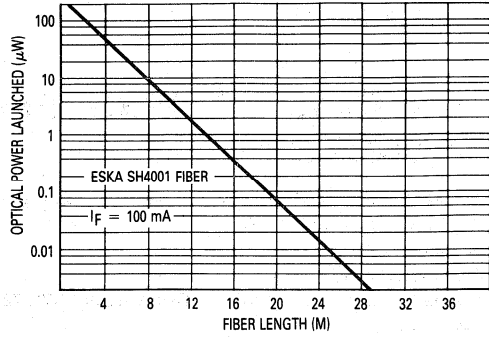

Figure 2. Power Launched versus Fiber Length

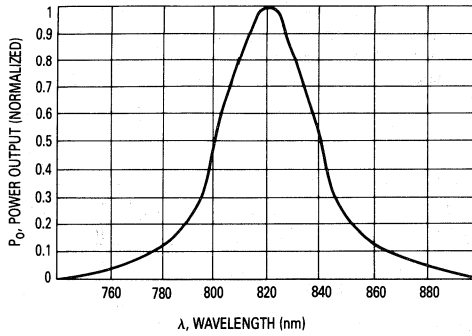

Figure 3. Typical Spectral Output versus Wavelength

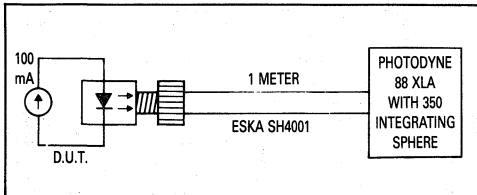

Figure 4. Power Launched Test Set

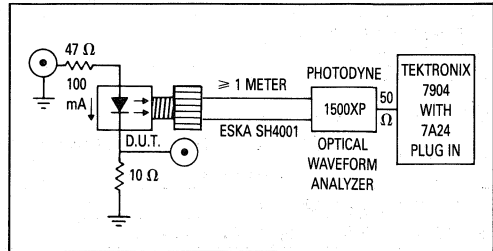

Figure 5. Optical Rise and Fall Time Test Set (10%–90%)

Fiber Optics — FLCS Family Visible Red LED

The MFOE76 is designed for low cost, medium frequency, fiber optic systems using 1000 micron core plastic fiber. It is compatible with Motorola's wide variety of detector functions from the MFOE70 series. The MFOE76 employs gallium aluminum technology, and comes pre-assembled into the convenient and popular FLCS connector.

Features:

- Low Cost
- Very Simple Fiber Termination and Connection. See Figure 9
- Convenient Printed Circuit Mounting
- Integral Molded Lens for Efficient, Coupling
- Mates with 1000 Micron Core Plastic Fiber, such as Eska SH4001

Applications:

- Medical Electronics
- Industrial Controls
- Security Systems
- Short Haul Communication Systems
- High Isolation Interconnects
- M6800 Microprocessor Systems

MFOE76

**FLCS FAMILY
 FIBER OPTICS
 VISIBLE RED
 LED
 660 nm**

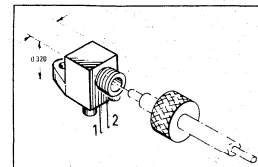

**CASE 363B-01
 STYLE 1**

MAXIMUM RATINGS

Rating	Symbol	Value	Unit
Reverse Voltage	V_R	5	Volts
Forward Current — Continuous	I_F	60	mA
Forward Current — Peak Pulse	I_F	1	A
Total Power Dissipation ($T_A = 25^\circ\text{C}$) Derate above 35°C	P_D	132 2	mW mW/ $^\circ\text{C}$
Ambient Operating Temperature Range	T_A	-40 to +100	$^\circ\text{C}$
Storage Temperature	T_{stg}	40 to +100	$^\circ\text{C}$
Lead Soldering Temperature (2)	—	260	$^\circ\text{C}$

Notes: 1. Measured with device soldered into a typical printed circuit board.
 2. 5 seconds max; 1/16 inch from case.

9

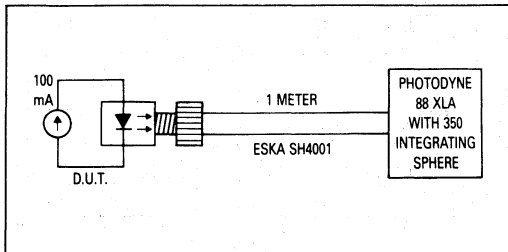

Figure 1. Power Launched Test Setup

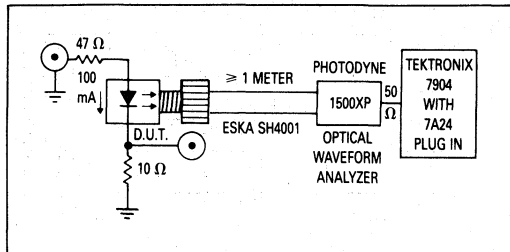

Figure 2. Optical Turn-On and Turn-Off Test Setup

MFOE76

ELECTRICAL CHARACTERISTICS ($T_A = 25^\circ\text{C}$ unless otherwise noted)

Characteristic	Symbol	Min	Typ	Max	Unit
Reverse Leakage Current ($V_R = 3\text{ V}$)	I_R	—	100	—	nA
Reverse Leakage Current ($V_R = 5\text{ V}$)	I_R	—	10	100	μA
Forward Voltage ($I_F = 60\text{ mA}$)	V_F	—	1.8	2.2	V
Temperature Coefficient of Forward Voltage	ΔV_F	—	-2.2	—	mV/K
Capacitance ($f = 1\text{ MHz}$)	C	—	50	—	pF

OPTICAL CHARACTERISTICS ($T_A = 25^\circ\text{C}$ unless otherwise noted)

Characteristic	Symbol	Min	Typ	Max	Unit
Peak Wavelength ($I_F = 60\text{ mA}$)	λ_p	—	660	—	nm
Instantaneous Power Launched ($I_F = 100\text{ mA}$, Figure 1)	P_L	200	540	—	μW
Optical Turn-On Time (Figure 2)	t_{on}	—	200	—	ns
Optical Turn-Off Time (Figure 2)	t_{off}	—	150	—	ns
Half-Power Electrical Bandwidth (1)	BWe	—	6	—	MHz

(1) $I_F = 100\text{ mA}$ pk-pk, 100% modulation.

TYPICAL CHARACTERISTICS

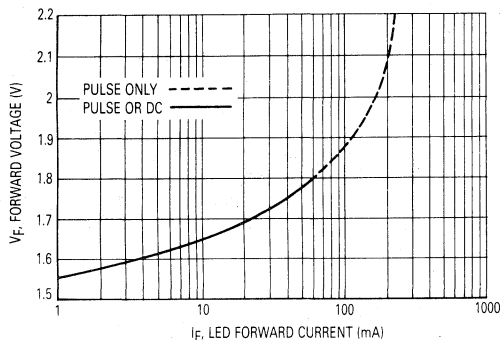

Figure 3. Forward Voltage versus Forward Current

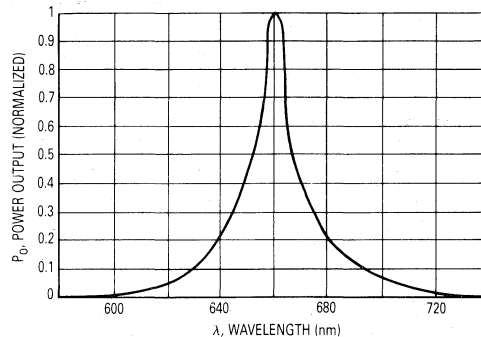

Figure 4. Relative Spectral Output

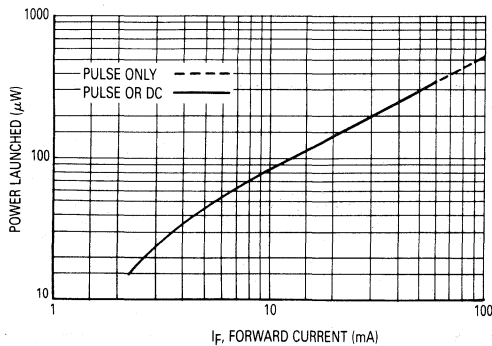

Figure 5. Power Launched versus LED Forward Current

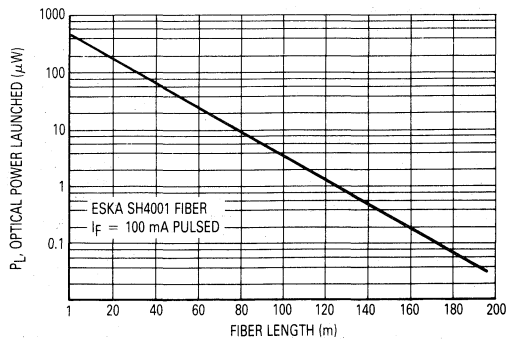

Figure 6. Power Launched versus Fiber Length

MFOE76

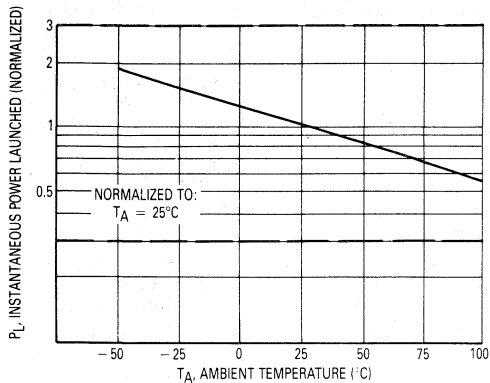

Figure 7. Instantaneous Power Output versus Ambient Temperature

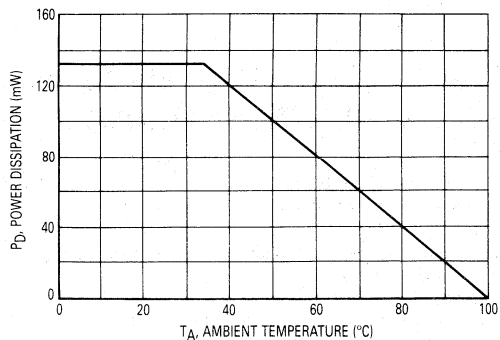

Figure 8. Power Dissipation

The system length achieved with a MFOE76 emitter and various detectors, using 1000 micron core plastic fiber (Eska SH4001 or equivalent), depends on the LED forward

current (I_f) and the responsivity of the detector chosen. Each detector will perform with the MFOE76 up to the distances shown below.

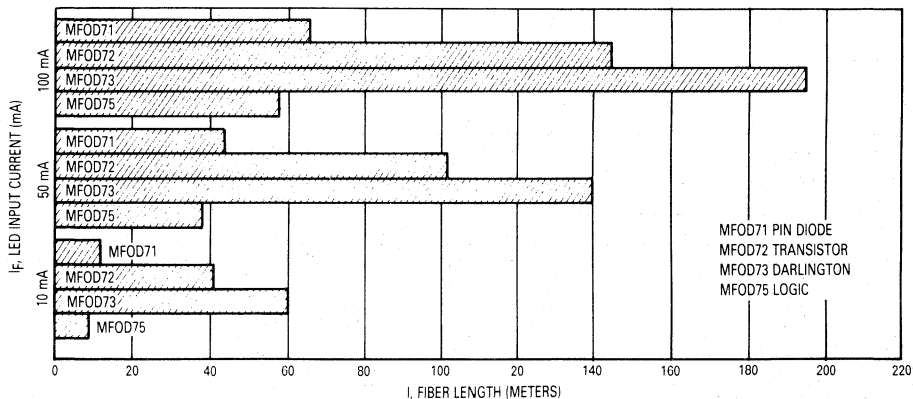

Figure 9. MFOE76 Working Distances

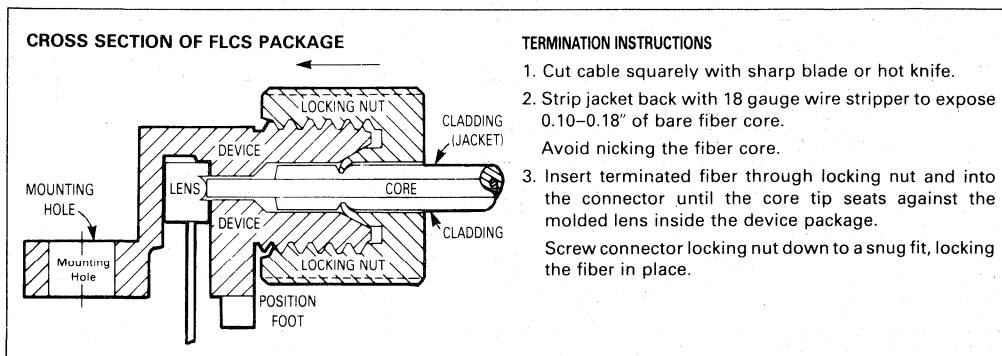

Figure 10. FO Cable Termination and Assembly

Fiber Optics — High Performance Family
Infrared LED (850 nm)

The MFOE1100, MFOE1101 and MFOE1102 are designed for fiber optics applications requiring high-power and medium response time.

Features:

- Response — Digital Data to 30 Mbaud (NRZ) Guaranteed
- High Launch Power
- Hermetic Package
- Internal Lensing Enhances Coupling Efficiency
- Complements All Motorola Fiber Optics Detectors
- Compatible with AMP #228756-1, Amphenol #905-138-5001 and Deutsch 3146-04 Receptacles Using Motorola Alignment Bushing MFOA06 (Included)

Applications:

- Medical Electronics
- Security Systems
- CATV
- Computer and Peripheral Equipment
- Industrial Controls
- M6800 Microprocessor Systems
- Video Systems
- Communication Systems

MAXIMUM RATINGS

Rating	Symbol	Value	Unit
Reverse Current	I_R	1	mA
Forward Current — Continuous	I_F	100	mA
Total Device Dissipation @ $T_A = 25^\circ\text{C}$ Derate above 25°C	P_D	250 2.27	mW mW/ $^\circ\text{C}$
Operating Temperature Range	T_A	-55 to +125	$^\circ\text{C}$
Storage Temperature Range	T_{stg}	-65 to +150	$^\circ\text{C}$

THERMAL CHARACTERISTICS

Characteristics	Symbol	Max	Unit
Thermal Resistance, Junction to Ambient	θ_{JA}	440 225*	$^\circ\text{C}/\text{W}$

ELECTRICAL CHARACTERISTICS ($T_A = 25^\circ\text{C}$)

Characteristic	Symbol	Min	Typ	Max	Unit
Reverse Breakdown Voltage ($I_R = 100 \mu\text{A}$)	$V_{(BR)R}$	2	8	—	Volts
Forward Voltage ($I_F = 100 \text{ mA}$)	V_F	1.8	2	2.2	Volts
Total Capacitance ($V_R = 0 \text{ V}$, $f = 1 \text{ MHz}$)	C_T	—	70	—	pF
Electrical Bandwidth, Figure 6 ($I_F = 80 \text{ mAdc}$, measured 1 MHz to 30 MHz)	BWE	15	20	—	MHz

OPTICAL CHARACTERISTICS ($T_A = 25^\circ\text{C}$)

Characteristic	Symbol	Min	Typ	Max	Unit
Total Power Output ($I_F = 100 \text{ mA}$, $\lambda \approx 850 \text{ nm}$)	P_O	—	2.6 4 5	—	mW
Power Launched, Figure 7 ($I_F = 100 \text{ mA}$)	P_L	60 (-12.2) 120 (-9.2) 180 (-7.5)	— — —	— 240 (-6.2) 360 (-4.5)	$\mu\text{W}(\text{dBm})$
Numerical Aperture of Output Port (at -10 dB), Figure 3 (250 μm [10 mil] diameter spot)	NA	—	0.30	—	—
Wavelength of Peak Emission @ 100 mAdc	λ	—	850	—	nm
Spectral Line Half Width	—	—	50	—	nm
Optical Rise and Fall Times, Figure 11 ($I_F = 100 \text{ mAdc}$)	t_r	—	15	—	ns
	t_f	—	16	—	

*Installed in compatible metal connector housing with Motorola alignment bushing.

MFOE1100
MFOE1101
MFOE1102

HERMETIC FAMILY
FIBER OPTICS
INFRARED LED

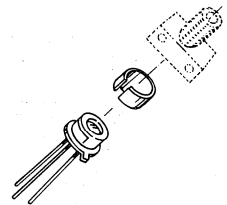

CASE 210A-01
METAL
STYLE 1

MFOE1100, MFOE1101, MFOE1102

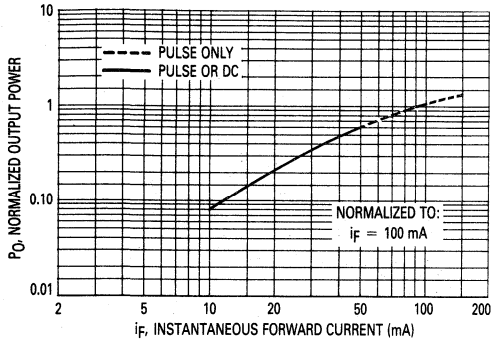

Figure 1. Normalized Output Power versus Forward Current

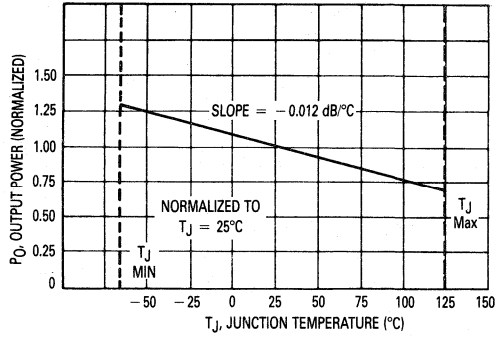

Figure 2. Power Output versus Junction Temperature

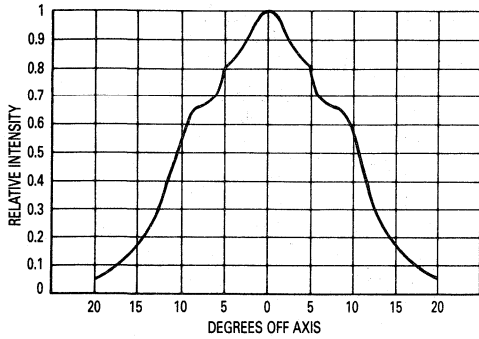

Figure 3. Radial Intensity Distribution

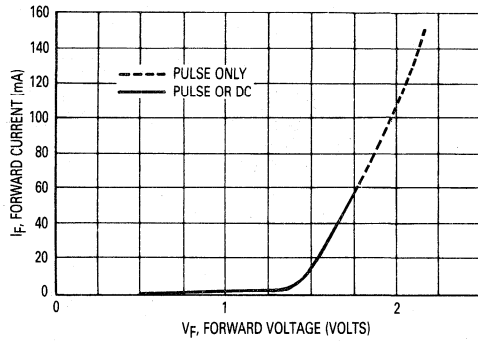

Figure 4. Forward Current versus Forward Voltage

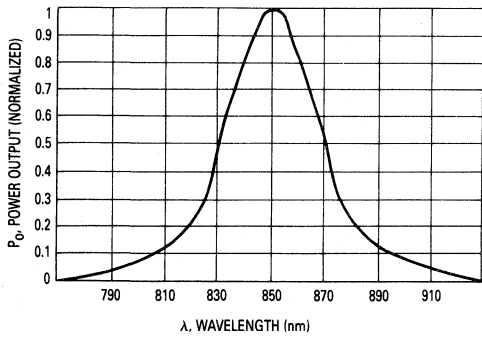

Figure 5. Spectral Output versus Wavelength

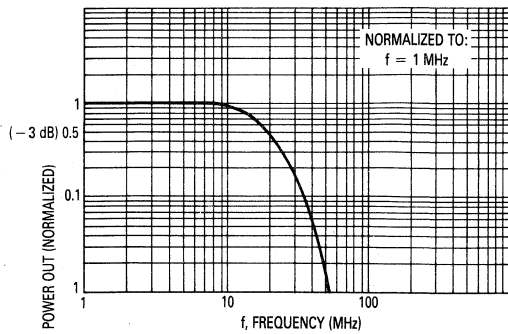

Figure 6. Normalized Output Power versus Frequency

MFOE1100, MFOE1101, MFOE1102

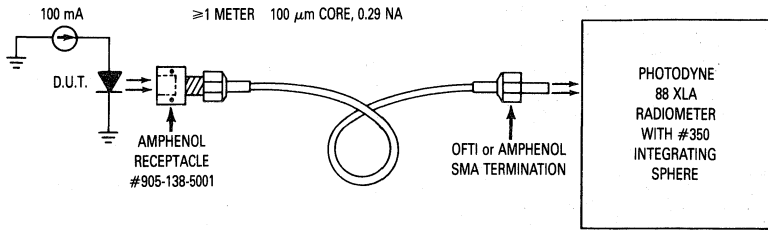

Figure 7. Launched Power Test Set

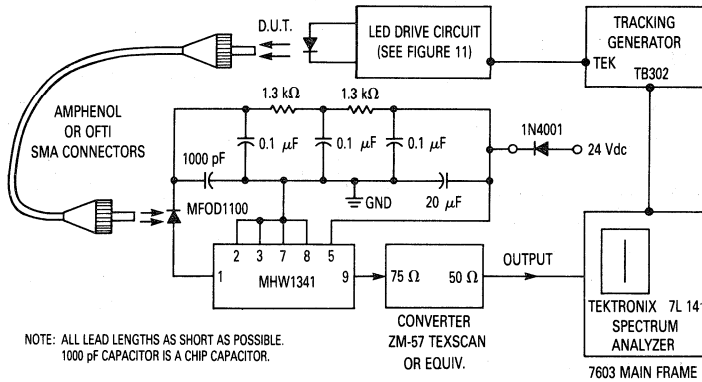
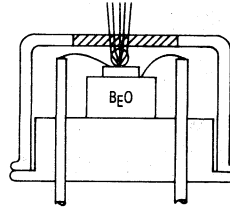

Figure 8. Bandwidth Test Set

MFOE1100, MFOE1101, MFOE1102

AVERAGE COUPLING EFFICIENCY		
Fiber Core Diameter (μm)	Numerical Aperture	Coupling Efficiency (%)
200	0.4	28
100	0.29	4.5
85	0.26	2.6
62.5	0.28	1.6
50	0.2	0.7

Figure 9. Coupling Efficiency



COMPATIBLE WITH AMP #228756-1, AMPHENOL #905-138-5001, DEUTSCH 3146-04 AND OFTI # PCR001 RECEPTACLES USING MOTOROLA ALIGNMENT BUSHING MFOA06 (INCLUDED)

Figure 10. Package Cross Section

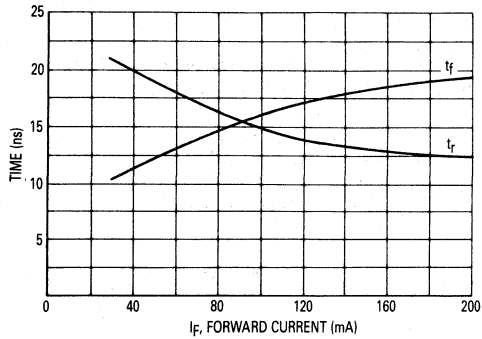

Figure 11. Rise and Fall Time versus Forward Current

Fiber Optics
Infrared LED (850 nm)

MFOE1200

The MFOE1200 is designed for fiber optics applications requiring high power and fast response time.

Features:

- Fast Response — > 70 MHz Bandwidth
- 250 μm Diameter Spot Size
- Hermetic Package
- Internal Lensing Enhances Coupling Efficiency
- Complements All Motorola FO Detectors
- Compatible With AMP #228756-1, Amphenol #905-138-5001, and Radiall #FO86600380 Receptacles Using Motorola Alignment Bushing MFOA06 (Included)

Applications:

- Medical Electronics
- Security Systems
- CATV
- Computer and Peripheral Equipment
- Industrial Controls
- M6800 Microprocessor Systems
- Video Systems
- Communication Systems

HERMETIC FAMILY
FIBER OPTICS
INFRARED LED

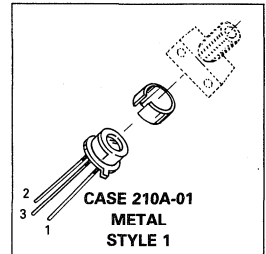

MAXIMUM RATINGS

Rating	Symbol	Value	Unit
Reverse Current	I_R	1	mA
Forward Current — Continuous	I_F	100	mA
Total Device Dissipation (at $T_A = 25^\circ\text{C}$ Derate above 25°C)	P_D	250 2.27	mW mW/ $^\circ\text{C}$
Operating Temperature Range	T_A	-55 to +125	$^\circ\text{C}$
Storage Temperature Range	T_{stg}	-65 to +150	$^\circ\text{C}$

THERMAL CHARACTERISTICS

Characteristic	Symbol	Max	Unit
Thermal Resistance, Junction to Ambient	θ_{JA}	440 225*	$^\circ\text{C/W}$

ELECTRICAL CHARACTERISTICS ($T_A = 25^\circ\text{C}$)

Characteristic	Symbol	Min	Typ	Max	Unit
Forward Voltage ($I_F = 100\text{ mA}$)	V_F	—	1.9	2.5	Volts
Total Capacitance ($V_R = 0\text{ V}$, $f = 1\text{ MHz}$)	C_T	—	70	—	pF

OPTICAL CHARACTERISTICS

Total Power Output from 250 μm Optical Spot ($I_F = 100\text{ mA}$, $\lambda \approx 850\text{ nm}$)	P_O	900	—	—	μW
Power Launched, Figure 4 ($I_F = 100\text{ mA}$)	P_L	25	—	—	μW
Numerical Aperture of Output Port (at -10 dB) (250 μm [10 mil] diameter spot)	NA	—	0.3	—	—
Wavelength of Peak Emission ($I_F = 100\text{ mAdc}$)	—	—	850	—	nm
Spectral Line Half Width	—	—	50	—	nm
Electrical Bandwidth ($I_F = 80\text{ mAdc}$)	BWE	70	—	—	MHz

*Installed in compatible metal connector housing with Motorola alignment bushing.

MFOE1200

TYPICAL CHARACTERISTICS

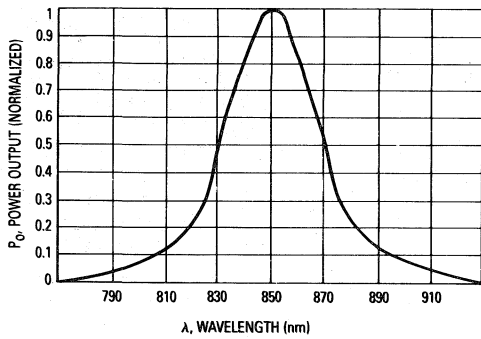

Figure 1. Relative Spectral Output

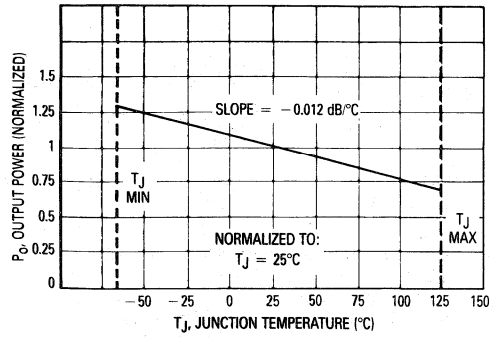

Figure 2. Power Output versus Junction Temperature

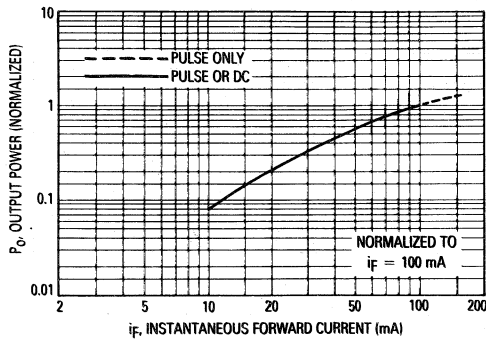

Figure 3. Power Output versus Forward Current

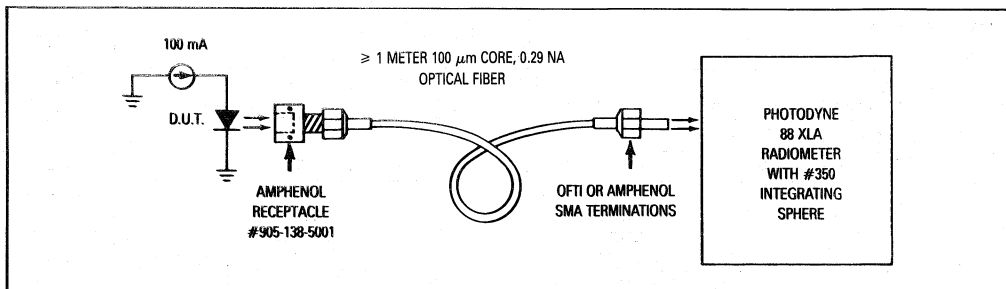

Figure 4. Launched Power (P_L) Test Set

Fiber Optics — High Performance Family
Infrared LED (850 nm)

The MFOE1201, MFOE1202 and MFOE1203 are designed for Short Haul (<2Km) fiber optics applications requiring fast response time.

Features:

- Fast Response — Digital Data to 200 Mbaud (NRZ)
- Guaranteed 100 MHz Analog Bandwidth
- Hermetic Package, Figure 10
- Internal Lensing Enhances Coupling Efficiency
- Complements All Motorola Fiber Optics Detectors

Applications:

- Medical Electronics
- Security Systems
- CATV
- Computer and Peripheral Equipment
- Industrial Controls
- M6800 Microprocessor Systems
- Video Systems
- Communication Systems

MAXIMUM RATINGS

Rating	Symbol	Value	Unit
Reverse Current	I_R	1	mA
Forward Current — Continuous	I_F	100	mA
Total Device Dissipation @ $T_A = 25^\circ\text{C}$ Derate above 25°C	P_D	250 2.27	mW mW/°C
Operating Temperature Range	T_A	-55 to +125	°C
Storage Temperature Range	T_{stg}	-65 to +150	°C

THERMAL CHARACTERISTICS

Characteristics	Symbol	Max	Unit
Thermal Resistance, Junction to Ambient	θ_{JA}	440 225*	°C/W

*Installed in compatible metal connector housing with Motorola alignment bushing.

ELECTRICAL CHARACTERISTICS ($T_A = 25^\circ\text{C}$)

Characteristic	Symbol	Min	Typ	Max	Unit
Reverse Breakdown Voltage ($I_R = 100 \mu\text{A}$)	$V_{(BR)R}$	2	4	—	Volts
Forward Voltage ($I_F = 100 \text{ mA}$)	V_F	1.5	1.9	2.2	Volts
Total Capacitance ($V_R = 0 \text{ V}$, $f = 1 \text{ MHz}$)	C_T	—	70	—	pF
Electrical Bandwidth, Figure 6 ($I_F = 80 \text{ mAdc}$, measured 10 MHz to 110 MHz)	BWE	100	—	—	MHz

OPTICAL CHARACTERISTICS ($T_A = 25^\circ\text{C}$)

Characteristic	Symbol	Min	Typ	Max	Unit
Total Power Output ($I_F = 100 \text{ mA}$, $\lambda \approx 850 \text{ nm}$)	P_O	—	1500 (1.76) 2400 (3.80) 2800 (4.46)	—	$\mu\text{W}(\text{dBm})$
Power Launched, Figure 7 ($I_F = 100 \text{ mA}$)	P_L	40(-14) 75(-11.3) 135(-8.7)	—	80(-11) 150(-8.3) 270(-5.7)	$\mu\text{W}(\text{dBm})$
Numerical Aperture of Output Port (at -10 dB), Figure 3 (250 μm [10 mil] diameter spot)	NA	—	0.3	—	—
Wavelength of Peak Emission @ 100 mAdc	λ	—	850	—	nm
Spectral Line Half Width	—	—	50	—	nm
Optical Rise and Fall Times, Figure 12 ($I_F = 100 \text{ mAdc}$)	t_r	—	2.8	4	ns
	t_f	—	3.5	6	

MFOE1201
MFOE1202
MFOE1203

HERMETIC FAMILY
FIBER OPTICS
INFRARED LED

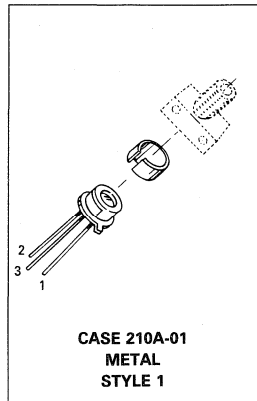

MFOE1201, MFOE1202, MFOE1203

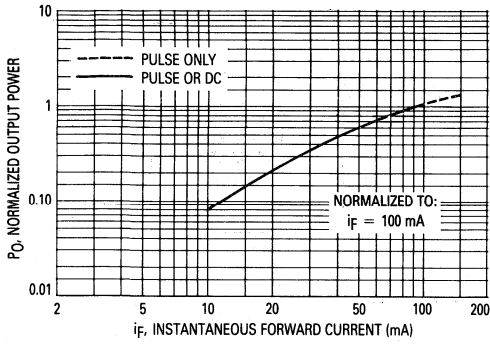

Figure 1. Normalized Output Power versus Forward Current

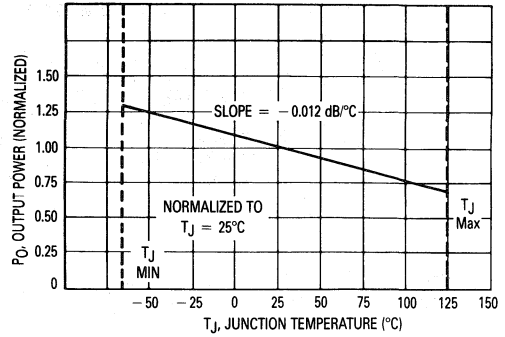

Figure 2. Power Output versus Junction Temperature

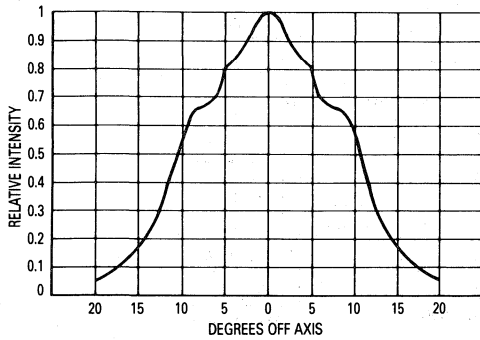

Figure 3. Radial Intensity Distribution

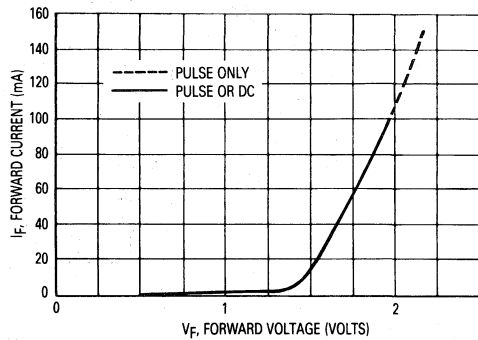

Figure 4. Forward Current versus Forward Voltage

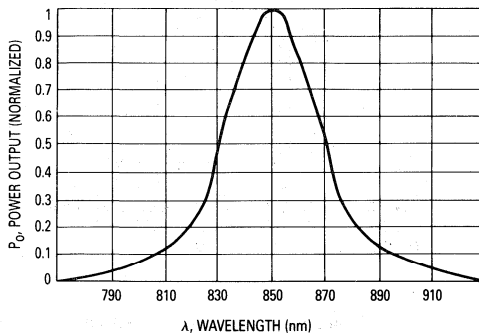

Figure 5. Spectral Output versus Wavelength

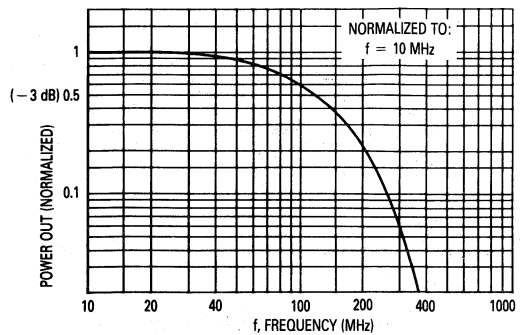

Figure 6. Normalized Output Power versus Frequency

MFOE1201, MFOE1202, MFOE1203

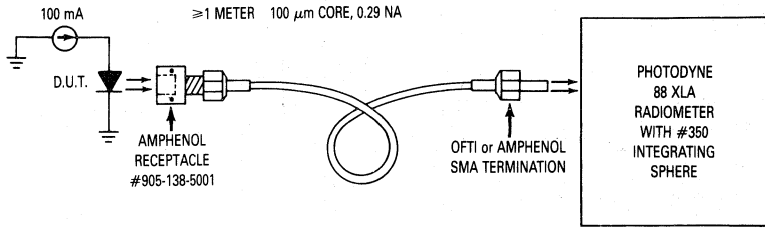

Figure 7. Launched Power Test Set

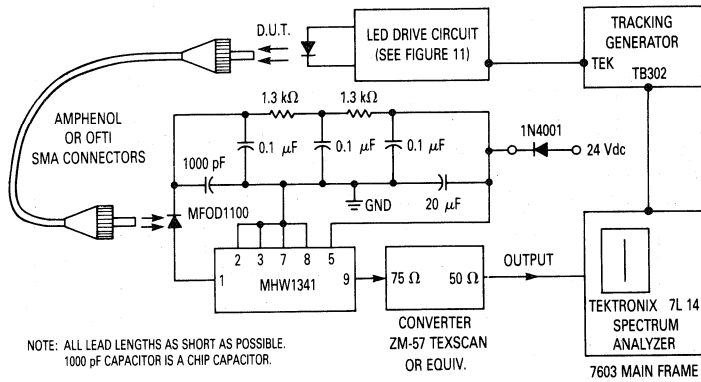
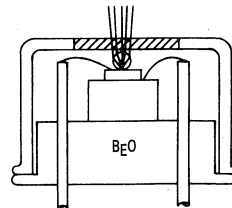

Figure 8. Bandwidth Test Set

AVERAGE COUPLING EFFICIENCY		
Fiber Core Diameter (μm)	Numerical Aperture	Coupling Efficiency (%)
200	0.4	28
100	0.29	4.5
85	0.26	2.6
62.5	0.28	1.6
50	0.2	0.7

Figure 9. Coupling Efficiency



COMPATIBLE WITH AMP #228756-1, AMPHENOL #905-138-5001 AND OFTI # PCR001 RECEPTACLES USING MOTOROLA ALIGNMENT BUSHING MFOA06 (INCLUDED)

Figure 10. Package Cross Section

MFOE1201, MFOE1202, MFOE1203

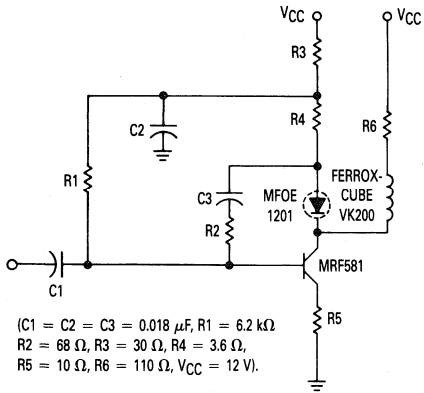

Figure 11. LED Drive Circuit to 100 MHz

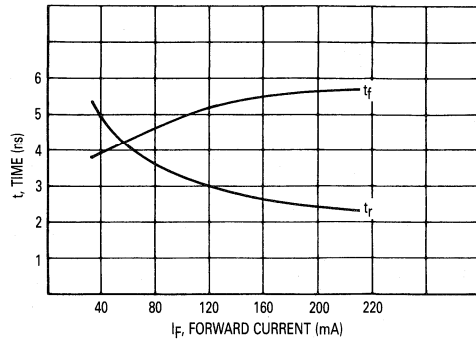
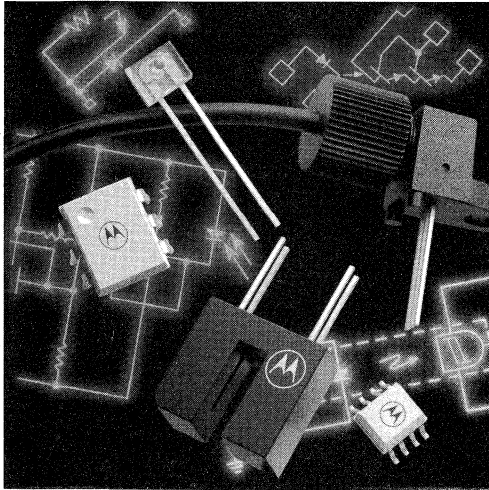

Figure 12. Rise and Fall Time versus Forward Current



Section Ten

Emitter/Detector Chips

MFODC1100WP	10-2
MFOEC1200WP	10-4
MLEDC1000WP	10-6
MRDC100WP	10-8
MRDC200WP	10-10
MRDC400WP	10-12
MRDC600WP	10-15

Photo Detector Chip

Diode Output

MFODC1100WP

**FIBER OPTICS
 PHOTO DETECTOR
 CHIP
 DIODE OUTPUT**

The MFODC1100WP is designed for infrared radiation detection in high frequency Fiber Optic Systems.

- Fast Response – 1 ns Max
- Anode/Cathode Metallization Compatible with Conventional Wire and Die Bonding Techniques
- Available in Chip or Wafer Form

MAXIMUM RATINGS ($T_A = 25^\circ\text{C}$ unless otherwise noted)

Rating	Symbol	Value	Unit
Reverse Voltage	V_R	50	Volts
Power Dissipation ⁽¹⁾	P_D	50	mW
Operating Junction Temperature Range	T_J	-65 to +125	$^\circ\text{C}$
Storage Temperature Range	T_{stg}	-65 to +200	$^\circ\text{C}$

STATIC ELECTRICAL CHARACTERISTICS ($T_A = 25^\circ\text{C}$ unless otherwise noted)

Characteristic	Symbol	Min	Typ	Max	Unit
Dark Current ($V_R = 5\text{ V}$, $R_L = 1\text{ M}\Omega$, $H = 0$)	I_D	—	—	1	nA
Reverse Breakdown Voltage ($I_R = 10\ \mu\text{A}$)	$V_{(BR)R}$	50	—	—	Volts
Forward Voltage ($I_F = 50\text{ mA}$)	V_F	—	0.7	1	Volts
Junction Capacitance ($V_R = 5\text{ V}$, $f = 1\text{ MHz}$)	C_j	—	—	2	pF

OPTICAL CHARACTERISTICS ($T_A = 25^\circ\text{C}$ unless otherwise noted)

Radiation Responsivity ($V_R = 5\text{ V}$, $\lambda = 850\text{ nm}$, $P = 10\ \mu\text{W}$)	R	0.3	0.4	—	$\mu\text{A}/\mu\text{W}$
Response Time ($V_R = 5\text{ V}$, $\lambda = 850\text{ nm}$)	t_r, t_f	—	0.5	1	ns

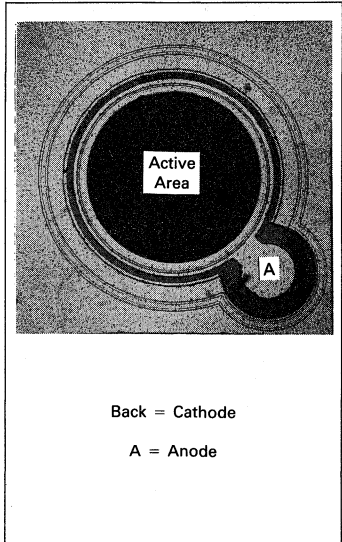

DIE SPECIFICATIONS

Die Size Mils	Die Thickness Mils	Bond Pad Size Mils		Metallization		Active Area Square Mils
		Anode	Cathode	Front ⁽²⁾	Back ⁽³⁾	
30 x 30	8-10	4 dia.	30 x 30	Al	Au	154

NOTES: 1. Maximum power dissipation rating is determined with chip mounted on a header or lead frame using conventional Motorola Semiconductor assembly techniques.
 2. Thickness — a minimum of 10,000 Å.
 3. Thickness — a minimum of 15,000 Å.

10

MFODC1100WP

TYPICAL CHARACTERISTICS

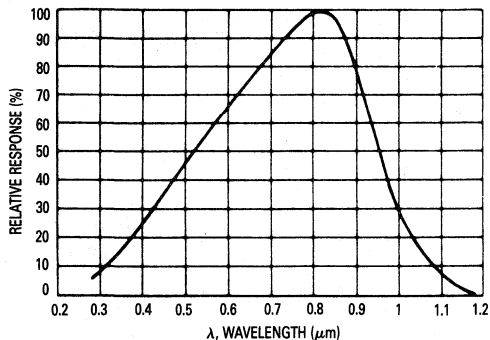

Figure 1. Relative Spectral Response

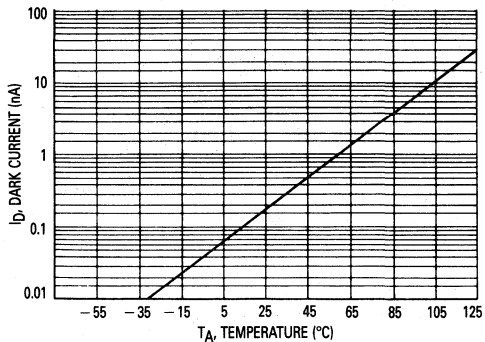

Figure 2. Dark Current versus Temperature

ORDERING INFORMATION

This die is available with the packaging and visual inspection listed below.

TABLE 1

Die Type Suffix	Packaging	Description	Visual Inspection
WP	Wafer Pak	Wafer-probed, unscribed, unbroken and heat sealed in plastic bag (rejects are inked)	Visual inspected by sample to a LTPD = 10

Infrared LED Chip

The MFOEC1200WP is designed for fiber optic applications requiring fast response time.

- Fast Response — 90 MHz Bandwidth Typ
- High Power Output — 1.5 mW Min
- Anode/Cathode Metallization Compatible with Conventional Wire and Die Bonding Techniques
- Available in Chip or Wafer Form

MFOEC1200WP

**FIBER OPTICS
 INFRARED
 LED CHIP**

MAXIMUM RATINGS ($T_A = 25^\circ\text{C}$ unless otherwise noted)

Rating	Symbol	Value	Unit
Reverse Voltage	V_R	2	Volts
Forward Current — Continuous	I_F	100	mA
Forward Current — Peak (1 μs Pulse, 50% Duty Cycle)	I_F	200	mA
Power Dissipation ⁽¹⁾	P_D	200	mW
Operating Junction Temperature Range	T_J	-65 to +125	$^\circ\text{C}$
Storage Temperature Range	T_{stg}	-65 to +150	$^\circ\text{C}$

STATIC ELECTRICAL CHARACTERISTICS ($T_A = 25^\circ\text{C}$ unless otherwise noted)

Characteristic	Symbol	Min	Typ	Max	Unit
Reverse Breakdown Voltage ($I_R = 100 \mu\text{A}$)	$V_{(BR)R}$	2	—	—	Volts
Forward Voltage ($I_F = 100 \text{ mA}$)	V_F	1	—	2.5	Volts
Junction Capacitance ($V_R = 0 \text{ V}$, $f = 1 \text{ MHz}$)	C_j	—	70	—	pF

OPTICAL CHARACTERISTICS ($T_A = 25^\circ\text{C}$ unless otherwise noted)

Total Power Output ($I_F = 100 \text{ mA}$)	P_O	1.5	—	—	mW
Wavelength of Peak Emission ($I_F = 100 \text{ mA}$)	λ_p	—	850	—	nm
Optical Rise Time ($I_F = 100 \text{ mA}$, 10%–90%)	t_r	—	4	5	ns
Optical Fall Time ($I_F = 100 \text{ mA}$, 10%–90%)	t_f	—	5	7	ns

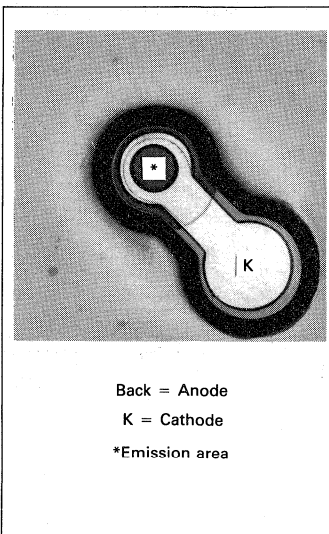

Back = Anode
 K = Cathode
 *Emission area

DIE SPECIFICATIONS

Die Size Mils	Die Thickness Mils	Bond Pad Size Mils		Metallization		Active Area Square Mils
		Anode	Cathode	Front ⁽²⁾	Back ⁽³⁾	
24 x 24	8–10	24 x 24	3.5 dia.	Au	Au	7

- NOTES: 1. Maximum power dissipation rating is determined with chip mounted on a header or lead frame using conventional Motorola Semiconductor assembly techniques.
 2. Thickness — a minimum of 10,000 Å.
 3. Thickness — a minimum of 15,000 Å.

MFOEC1200WP

TYPICAL CHARACTERISTICS

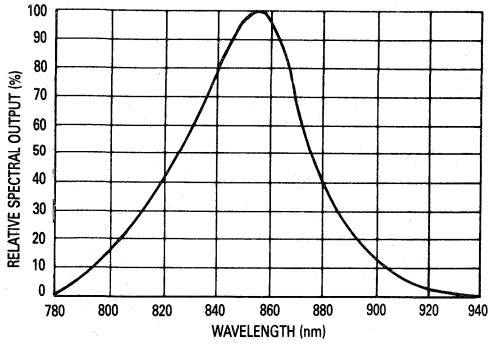

Figure 1. Spectral Output versus Wavelength

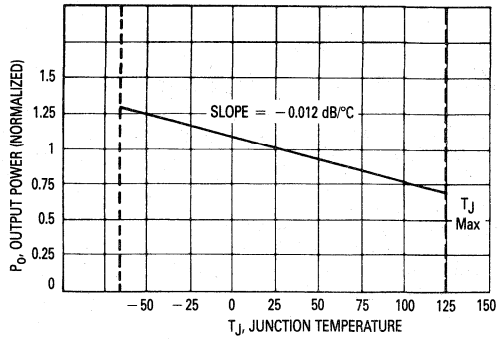

Figure 2. Power Output versus Junction Temperature

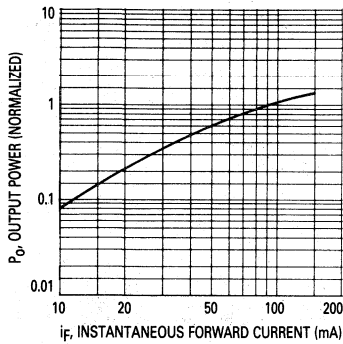

Figure 3. Normalized Output Power versus Forward Current

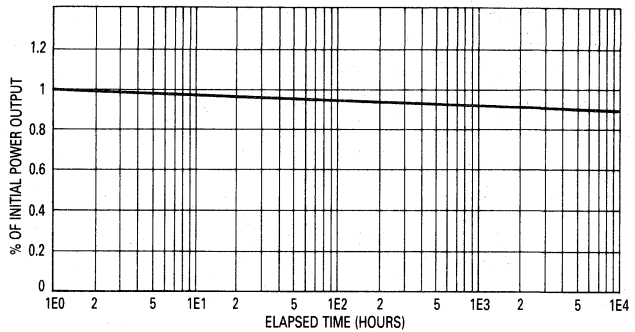

Figure 4. Power Output versus Time

ORDERING INFORMATION

This die is available with the packaging and visual inspection listed below.

TABLE 1

Die Type Suffix	Packaging	Description	Visual Inspection
WP	Wafer Pak	Wafer-probed, unscribed, unbroken and heat sealed in plastic bag (rejects are inked)	Visual inspected by sample to a LTPD = 10

Infrared LED Chip

The MLEDC1000WP is designed for applications requiring a stable, high power, low drive current infrared emitting diode which is spectrally matched for use with silicon detectors.

- High Power Output — 2 mW Min
- Infrared Emission — 940 nm Typ
- Low Drive Current — 50 mA Typ
- Metallization Compatible with Conventional Wire and Die Bonding Techniques
- Available in Chip or Wafer Form

MLEDC1000WP

GaAs
INFRARED
LED CHIP

MAXIMUM RATINGS ($T_A = 25^\circ\text{C}$ unless otherwise noted)

Rating	Symbol	Value	Unit
Reverse Voltage	V_R	3	Volts
Forward Current, Continuous	I_F	100	mA
Forward Current, Peak (1 μs Pulse, 1% Duty Cycle)	I_F	1	A
Power Dissipation ⁽¹⁾	P_D	150	mW
Operating Junction Temperature Range	T_J	-65 to +125	$^\circ\text{C}$
Storage Temperature Range	T_{stg}	-65 to +150	$^\circ\text{C}$

STATIC ELECTRICAL CHARACTERISTICS ($T_A = 25^\circ\text{C}$ unless otherwise noted)

Characteristic	Symbol	Min	Typ	Max	Unit
Reverse Breakdown Voltage ($I_R = 100 \mu\text{A}$)	$V_{(BR)R}$	3	—	—	Volts
Forward Voltage ($I_F = 50 \text{ mA}$)	V_F	—	—	1.5	Volts
Junction Capacitance ($V_R = 0 \text{ V}$, $f = 1 \text{ MHz}$)	C_j	—	150	—	pF

OPTICAL CHARACTERISTICS ($T_A = 25^\circ\text{C}$ unless otherwise noted)

Total Power Output ($I_F = 50 \text{ mA}$)	P_O	2	—	—	mW
Peak Emission Wavelength ($I_F = 50 \text{ mA}$)	λ_P	—	940	—	nm
Optical Rise Time ($I_F = 10 \text{ mA}$, 10% to 90%)	t_r	—	600	—	μs
Optical Fall Time ($I_F = 10 \text{ mA}$, 10% to 90%)	t_f	—	600	—	μs

DIE SPECIFICATIONS

Die Size Mils	Die Thickness Mils	Bond Pad Size Mils		Metallization		Active Area Square Mils
		Anode	Cathode	Front ⁽²⁾	Back ⁽³⁾	
16 x 16	8-10	4 x 4	16 x 16	Al	Au	240

NOTES: 1. Maximum power dissipation rating is determined with chip mounted on a header or lead frame using conventional Motorola Semiconductor assembly techniques.

2. Thickness — a minimum of 10,000 Å.

3. Thickness — a minimum of 15,000 Å.

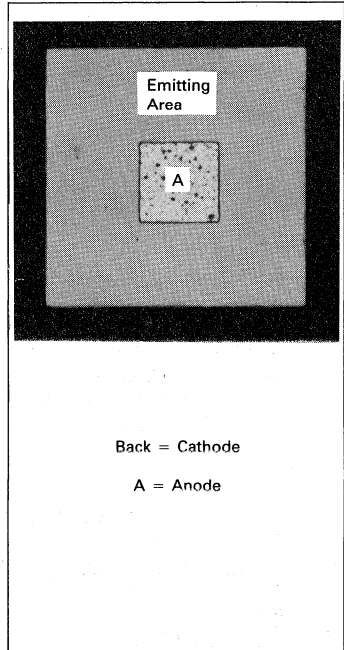

MLEDC1000WP

TYPICAL CHARACTERISTICS

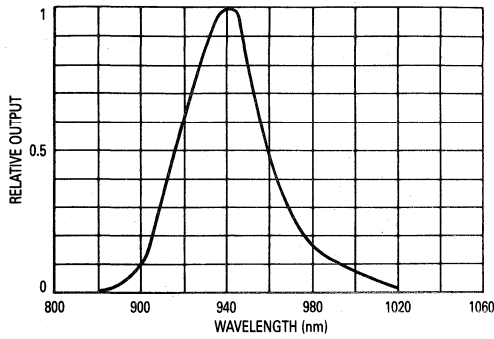

Figure 1. Relative Spectral Output

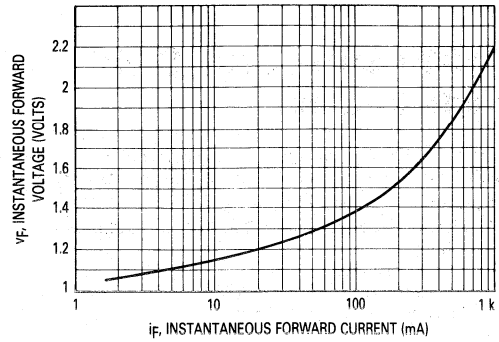

Figure 2. Forward Characteristics

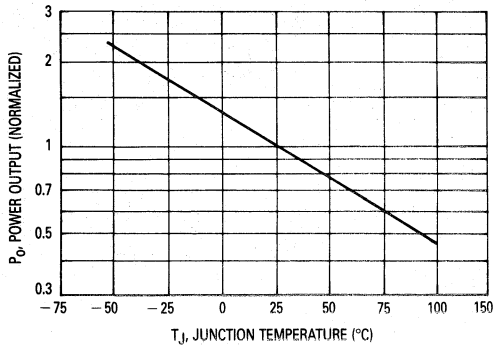

Figure 3. Power Output versus Junction Temperature

ORDERING INFORMATION

This die is available with the packaging and visual inspection listed below.

TABLE 1

Die Type Suffix	Packaging	Description	Visual Inspection
WP	Wafer Pak	Wafer-probed, unscribed, unbroken and heat sealed in plastic bag (rejects are inked)	Visual inspected by sample to a LTPD = 10

Photo Detector Chip

Diode Output

MRDC100WP

**PHOTO DETECTOR
 CHIP
 PIN SILICON
 DIODE OUTPUT**

The MRDC100WP is designed for the detection and demodulation of near infrared and visible light sources where ultrahigh speed and stable characteristics are required.

- Silicon Nitride Passivated Junction
- Anode/Cathode Metallization Compatible with Conventional Wire and Die Bonding Techniques
- Ultra Fast Response — 1 ns Typ
- High Responsivity — 0.4 $\mu\text{A}/\mu\text{W}$ Typ
- Available in Chip or Wafer Form

MAXIMUM RATINGS ($T_A = 25^\circ\text{C}$ unless otherwise noted)

Rating	Symbol	Value	Unit
Reverse Voltage	V_R	100	Volts
Power Dissipation ⁽¹⁾	P_D	100	mW
Operating Junction and Storage Temperature	T_J, T_{stg}	-65 to +200	$^\circ\text{C}$

STATIC ELECTRICAL CHARACTERISTICS ($T_A = 25^\circ\text{C}$ unless otherwise noted)

Characteristic	Symbol	Min	Typ	Max	Unit
Dark Current ($V_R = 20\text{ V}, H = 0$)	I_D	—	—	10	nA
Reverse Breakdown Voltage ($I_R = 10\ \mu\text{A}$)	$V_{(BR)R}$	100	—	—	Volts
Forward Voltage ($I_F = 50\text{ mA}$)	V_F	—	—	1.5	Volts
Junction Capacitance ($V_R = 20\text{ V}, f = 1\text{ MHz}$)	C_j	—	2.5	4	pF

OPTICAL CHARACTERISTICS ($T_A = 25^\circ\text{C}$ unless otherwise noted)

Responsivity ($V_R = 20\text{ V}, \lambda = 850\text{ nm}$)	R	0.3	0.4	—	$\mu\text{A}/\mu\text{W}$
Switching Times ($V_R = 20\text{ V}, R_L = 50\ \Omega, \lambda = 850\text{ nm}, H = 1\text{ mW}/\text{cm}^2$)	t_{on}, t_{off}	—	1	—	ns

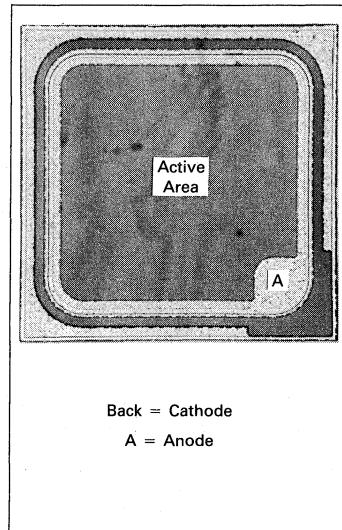

Back = Cathode
 A = Anode

DIE SPECIFICATIONS

Die Size Mils	Die Thickness Mils	Bond Pad Size Mils		Metallization		Active Area Square Mils
		Anode	Cathode	Front ⁽²⁾	Back ⁽³⁾	
30 x 30	8-10	4.5 x 4.5	30 x 30	Al	Au	380

- NOTES: 1. Maximum power dissipation rating is determined with chip mounted on a header or lead frame using conventional Motorola Semiconductor assembly techniques.
 2. Thickness — a minimum of 10,000 Å.
 3. Thickness — a minimum of 15,000 Å.

MRDC100WP

TYPICAL CHARACTERISTICS

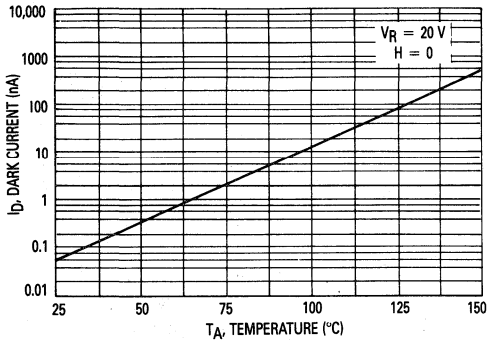

Figure 1. Dark Current versus Temperature

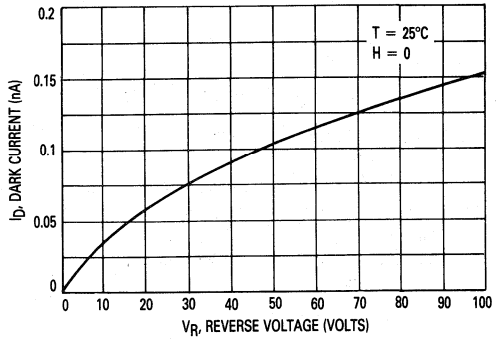

Figure 2. Dark Current versus Reverse Voltage

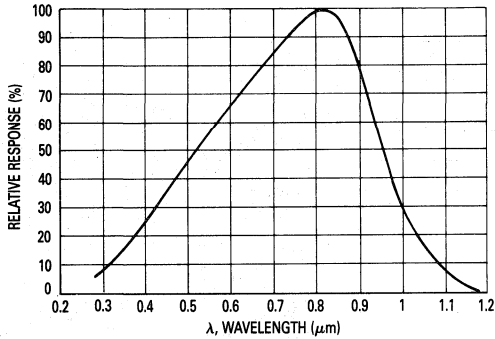

Figure 3. Relative Spectral Response

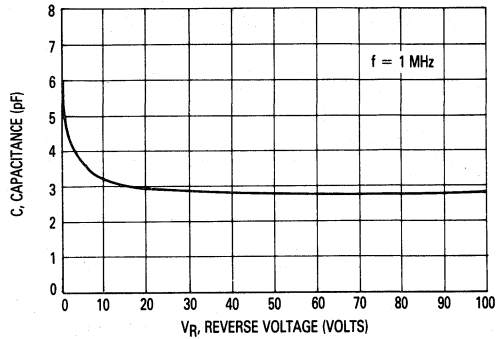

Figure 4. Capacitance versus Voltage

ORDERING INFORMATION

This die is available with the packaging and visual inspection listed below.

TABLE 1

Die Type Suffix	Packaging	Description	Visual Inspection
WP	Wafer Pak	Wafer-probed, unscribed, unbroken and heat sealed in plastic bag (rejects are inked)	Visual inspected by sample to a LTPD = 10

Photo Detector Chip

Transistor Output

MRDC200WP

**PHOTO DETECTOR
 CHIP
 NPN SILICON
 TRANSISTOR OUTPUT**

The MRDC200WP is designed for detection and demodulation of near infrared and visible light sources where high sensitivity and stable characteristics are required.

- Silicon Nitride Passivation
- Emitter, Base, Collector Metallization Compatible with Conventional Wire and Die Bonding Techniques
- Available in Chip or Wafer Form

MAXIMUM RATINGS ($T_A = 25^\circ\text{C}$ unless otherwise noted)

Rating	Symbol	Value	Unit
Collector-Emitter Voltage	V_{CEO}	40	Volts
Emitter-Collector Voltage	V_{ECO}	7	Volts
Collector-Base Voltage	V_{CBO}	70	Volts
Power Dissipation ⁽¹⁾	P_D	100	mW
Operating Junction Temperature Range	T_J	-65 to +150	$^\circ\text{C}$
Storage Temperature Range	T_{stg}	-65 to +200	$^\circ\text{C}$

STATIC ELECTRICAL CHARACTERISTICS ($T_A = 25^\circ\text{C}$ unless otherwise noted)

Characteristic	Symbol	Min	Typ	Max	Unit
Collector Dark Current ($V_{CE} = 10\text{ V}, I_H \approx 0$)	I_{CEO}	—	—	100	nA
Collector-Base Breakdown Voltage ($I_{CB} = 100\ \mu\text{A}$)	$V_{(BR)CBO}$	70	—	—	Volts
Collector-Emitter Breakdown Voltage ($I_{CE} = 100\ \mu\text{A}$)	$V_{(BR)CEO}$	40	—	—	Volts
Emitter-Collector Breakdown Voltage ($I_{EC} = 100\ \mu\text{A}$)	$V_{(BR)ECO}$	7	—	—	Volts

OPTICAL CHARACTERISTICS ($T_A = 25^\circ\text{C}$ unless otherwise noted)

Light Current ($V_C = 5\text{ V}, R_L = 100\ \text{Ohms}$) ⁽²⁾	I_L	0.8	—	22	mA
Optical Turn-on Time ($I_L = 1\text{ mA}, \lambda = 940\text{ nm}, V_{CE} = 10\text{ V}$) $R_L = 100\ \Omega$ $R_L = 1000\ \Omega$	t_{on}	—	9	—	μs
		—	11	—	
Optical Turn-off Time ($I_L = 1\text{ mA}, \lambda = 940\text{ nm}, V_{CE} = 10\text{ V}$) $R_L = 100\ \Omega$ $R_L = 1000\ \Omega$	t_{off}	—	8.5	—	μs
		—	13	—	

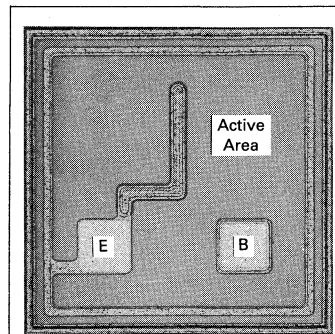

Back = Collector

B = Base
 E = Emitter

DIE SPECIFICATIONS

Die Size Mils	Die Thickness Mils	Bond Pad Size Mils		Metallization		Active Area Square Mils
		Emitter	Base	Front ⁽³⁾	Back ⁽⁴⁾	
25 x 25	8-10	3.5 x 3.5	3.5 x 3.5	Al	Au	270

- NOTES: 1. Maximum power dissipation rating is determined with chip mounted on a header or lead frame using conventional Motorola Semiconductor assembly techniques.
 2. Radiation flux density (H) equal to 5 mW/cm² emitted from a tungsten source at a color temperature of 2870K.
 3. Thickness — a minimum of 10,000 Å.
 4. Thickness — a minimum of 15,000 Å.

MRDC200WP

TYPICAL CHARACTERISTICS

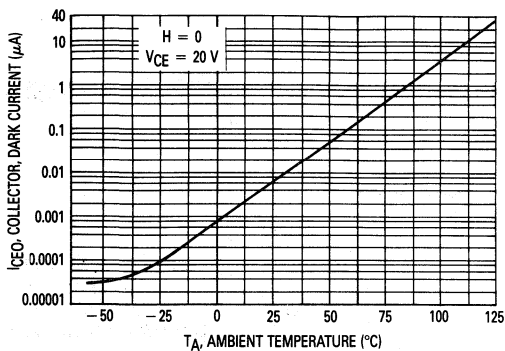

Figure 1. Dark Current versus Temperature

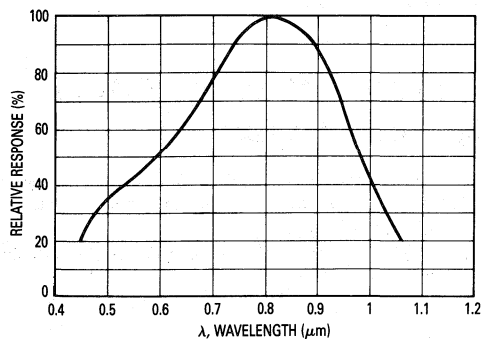

Figure 2. Constant Energy Spectral Response

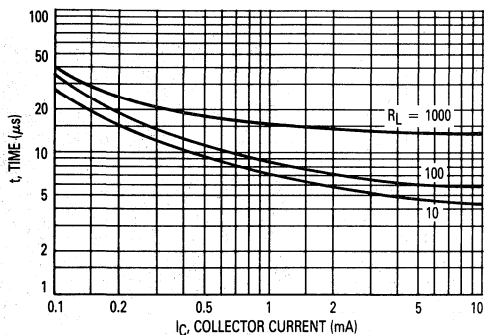

Figure 3. Typical Turn-On Switching Times

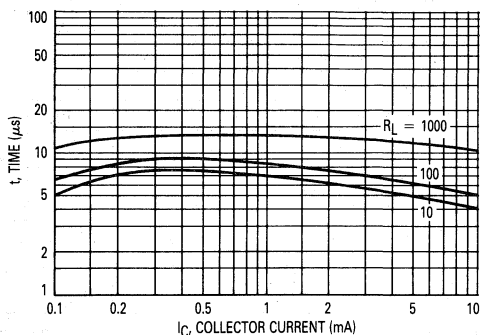

Figure 4. Typical Turn-Off Switching Times

ORDERING INFORMATION

This die is available with the packaging and visual inspection listed below.

TABLE 1

Die Type Suffix	Packaging	Description	Visual Inspection
WP	Wafer Pak	Wafer-probed, unscrubbed, unbroken and heat sealed in plastic bag (rejects are inked)	Visual inspected by sample to a LTPD = 10

Photo Detector Chip Darlington Output

The MRDC400WP is designed for detection and demodulation of near infrared and visible light sources where high sensitivity and stable characteristics are required.

- Silicon Nitride Passivation
- Emitter, Base, Collector Metallization Compatible with Conventional Wire and Die Bonding Techniques
- Available in Chip or Wafer Form

MRDC400WP

**PHOTO DETECTOR
CHIP
NPN SILICON
DARLINGTON OUTPUT**

MAXIMUM RATINGS (T_A = 25°C unless otherwise noted)

Rating	Symbol	Value	Unit
Collector-Emitter Voltage	V _{CEO}	50	Volts
Emitter-Base Voltage	V _{EBO}	6	Volts
Collector-Base Voltage	V _{CBO}	60	Volts
Power Dissipation ⁽¹⁾	P _D	250	mW
Operating Junction Temperature Range	T _J	-65 to +150	°C
Storage Temperature Range	T _{stg}	-65 to +200	°C

STATIC ELECTRICAL CHARACTERISTICS (T_A = 25°C unless otherwise noted)

Characteristic	Symbol	Min	Typ	Max	Unit
Collector Dark Current (V _{CE} = 10 V, H ≈ 0)	I _{CEO}	—	—	100	nA
Collector-Base Breakdown Voltage (I _C = 100 μA)	V _{(BR)CBO}	55	—	—	Volts
Collector-Emitter Breakdown Voltage (I _C = 1 mA)	V _{(BR)CEO}	45	—	—	Volts
Emitter Base Leakage Current (V _{EB} = 10 V)	I _{EBO}	—	—	100	μA

OPTICAL CHARACTERISTICS (T_A = 25°C unless otherwise noted)

Light Current (V _{CE} = 5 V, R _L = 10 Ohms) ⁽²⁾	I _L	0.8	—	20	mA
Optical Turn-On Time (V _{CE} = 10 V, I _C = 20 mA, λ = 940 nm)	t _{on}	R _L = 100 Ω	—	30	μs
		R _L = 1000 Ω	—	140	
Optical Turn-Off Time (V _{CE} = 10 V, I _C = 20 mA, λ = 940 nm)	t _{off}	R _L = 100 Ω	—	35	μs
		R _L = 1000 Ω	—	210	

DIE SPECIFICATIONS

Die Size Mils	Die Thickness Mils	Bond Pad Size Mils		Metallization		Active Area Square Mils
		Emitter	Base	Front ⁽³⁾	Back ⁽⁴⁾	
27 x 27	8-10	4 x 4	4 dia.	Al	Au	357

- NOTES:
1. Maximum power dissipation rating is determined with chip mounted on a header or lead frame using conventional Motorola Semiconductor assembly techniques.
 2. Radiation flux density (H) equal to 1 mW/cm² emitted from a tungsten source at a color temperature of 2870K.
 3. Thickness — a minimum of 10,000 Å.
 4. Thickness — a minimum of 15,000 Å.

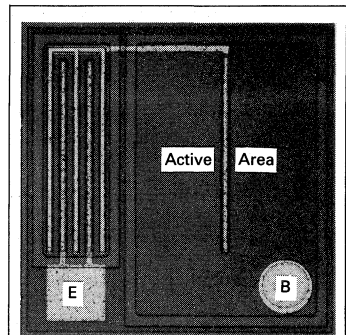

Back = Collector

B = Base
E = Emitter

MRDC400WP

TYPICAL CHARACTERISTICS

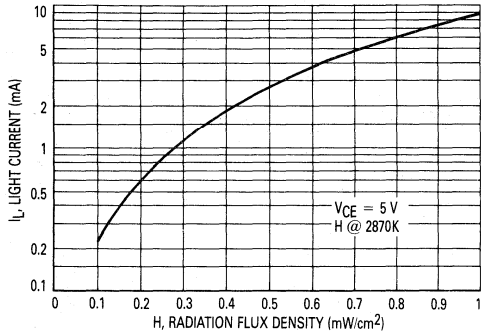

Figure 1. Light Current versus Irradiance

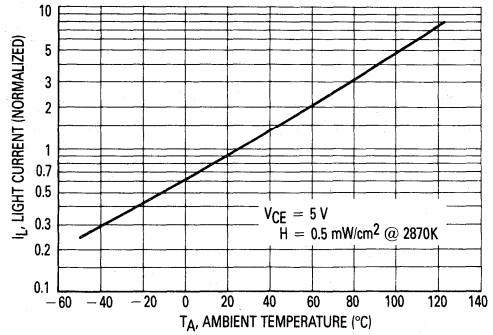

Figure 2. Normalized Light Current versus Temperature

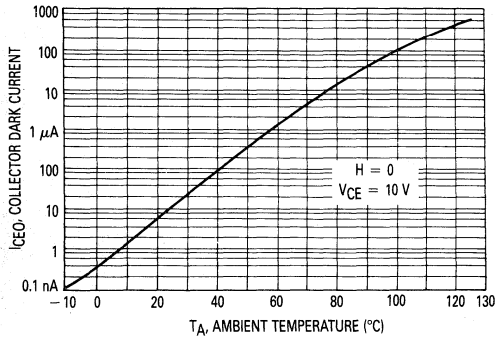

Figure 3. Dark Current versus Temperature

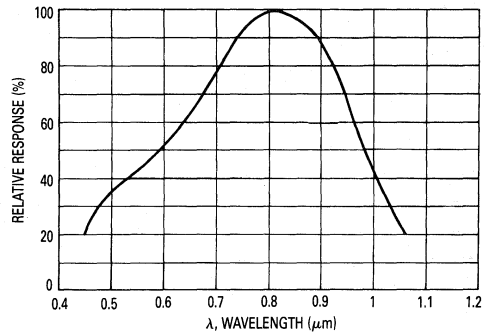

Figure 4. Constant Energy Spectral Response

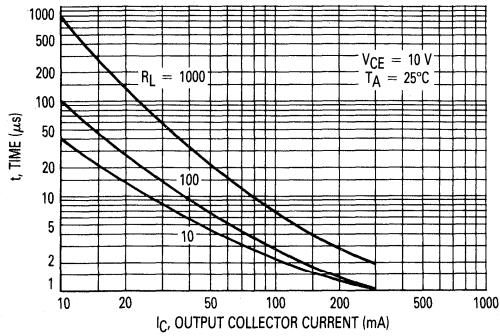

Figure 5. Typical Turn-On Switching Times

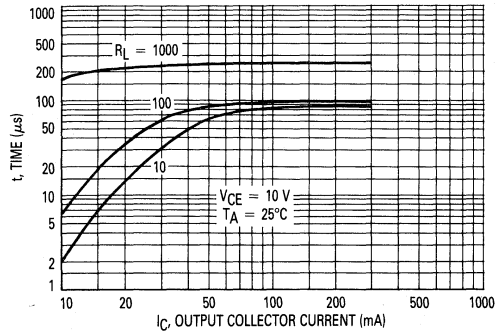

Figure 6. Typical Turn-Off Switching Times

MRDC400WP

ORDERING INFORMATION

This die is available with the packaging and visual inspection listed below.

TABLE 1

Die Type Suffix	Packaging	Description	Visual Inspection
WP	Wafer Pak	Wafer-probed, unscrubbed, unbroken and heat sealed in plastic bag (rejects are inked)	Visual inspected by sample to a LTPD = 10

Photo Detector Chip Triac Driver Output

The MRDC600WP is designed for use with IRED (MLEDC1000) to optically couple logic systems with power triacs to control equipment powered from 120 Vac and 240 Vac lines.

- Zero Voltage Crossing
- High Blocking Voltage — $V_{DRM} = 600$ V Min
- Metallization Compatible with Conventional Wire and Die Bonding Techniques
- Available in Chip or Wafer Form

MRDC600WP

**PHOTO DETECTOR CHIP
 TRIAC DRIVER
 OUTPUT**

MAXIMUM RATINGS ($T_A = 25^\circ\text{C}$ unless otherwise noted)

Rating	Symbol	Value	Unit
Off-State Output Terminal Voltage	V_{DRM}	600	Volts
Peak Repetitive Current ($PW = 100 \mu\text{s}$, 120 pps)	I_T	300	mA
Peak Nonrepetitive Surge Current ($PW = 10$ ms)	I_{TSM}	1.2	A
Total Power Dissipation (Note 1)	P_D	300	mW
Operating Junction Temperature Range	T_J	-40 to +100	$^\circ\text{C}$
Storage Temperature Range	T_{stg}	-65 to +200	$^\circ\text{C}$

STATIC ELECTRICAL CHARACTERISTICS ($T_A = 25^\circ\text{C}$ unless otherwise noted)

Characteristic	Symbol	Min	Typ	Max	Unit
Peak Blocking Current, Either Direction (Note 2) ($V_{DRM} = 600$ V)	I_{DRM1}	—	60	500	nA
Peak On-State Voltage, Either Direction ($I_{TM} = 100$ mA Peak)	V_{TM}	—	1.8	3	Volts
Critical Rate of Rise of Off-State Voltage	dv/dt	—	1500	—	$\text{V}/\mu\text{s}$
Critical Rate of Rise of On-State Voltage	dv/dt	—	0.15	—	$\text{V}/\mu\text{s}$

OPTICAL CHARACTERISTICS ($T_A = 25^\circ\text{C}$ unless otherwise noted)

Radiation Flux Density ($V_{TM} = 3$ V, $R_L = 150 \Omega$, $\lambda = 940$ nm)	H_{FT}	—	5	10	mW/cm^2
Holding Current, Either Direction ($H = 10$ mW/cm^2 , $\lambda = 940$ nm)	I_H	—	100	—	μA

ZERO CROSSING CHARACTERISTICS ($T_A = 25^\circ\text{C}$ unless otherwise noted)

Leakage in Inhibited State ($V_{DRM} = 400$ V, $H = 20$ mW/cm^2 , $\lambda = 940$ nm)	I_{DRM2}	—	100	300	μA
Inhibit Voltage ($H = 20$ mW/cm^2 , MT1–MT2 Voltage above which device will not trigger)	V_{IH}	—	10	20	V

DIE SPECIFICATIONS

Die Size Mils	Die Thickness Mils	Bond Pad Size Mils MT1–MT2	Metallization		Active Area Square Mils
			Front ⁽³⁾	Back ⁽⁴⁾	
45 x 45	8–10	4.6 Dia.	Al	Au	1400

NOTES: 1. Maximum power dissipation rating is determined with chip mounted on a header or lead frame using conventional Motorola Semiconductor assembly techniques.

2. Test voltage must be applied within off state dv/dt rating.

3. Thickness — a minimum of 10,000 Å.

4. Thickness — a minimum of 15,000 Å.

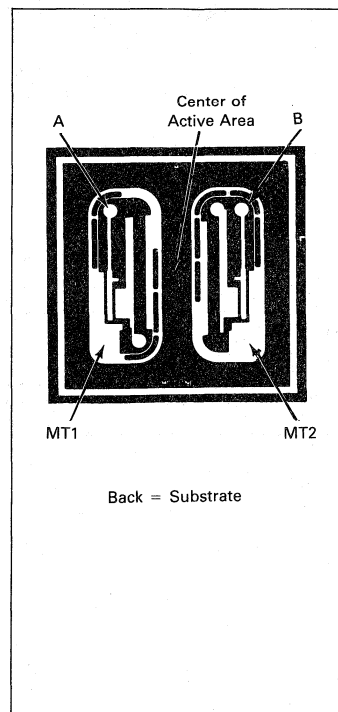

10

MRDC600WP

TYPICAL CHARACTERISTICS

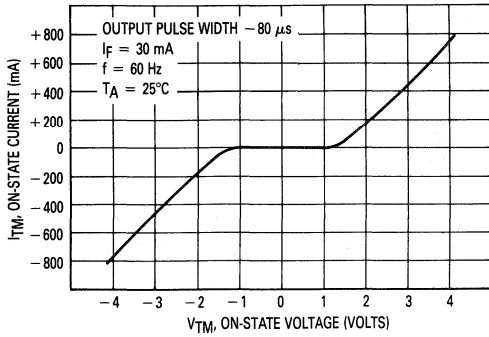

Figure 1. On-State Characteristics

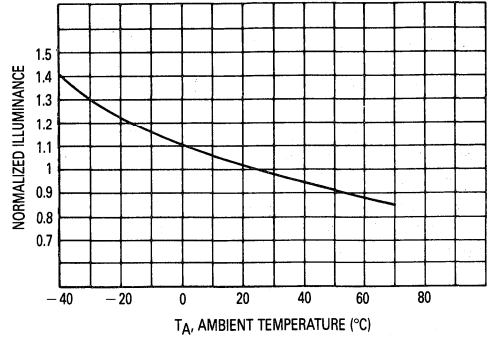

Figure 2. Illuminance versus Temperature

ORDERING INFORMATION

This die is available with the packaging and visual inspection listed below.

TABLE 1

Die Type Suffix	Packaging	Description	Visual Inspection
WP	Wafer Pak	Wafer-probed, unscribed, unbroken and heat sealed in plastic bag (rejects are inked)	Visual inspected by sample to a LTPD = 10

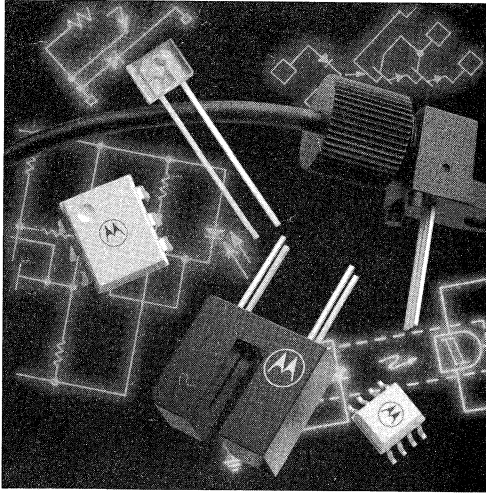

Section Eleven

Applications Information

Applications Circuits	11-2
Emitter/Detector Application Circuits	11-2
Optoisolator Application Circuits	11-5
Applications Information	11-13
AN440 Theory and Characteristics of Phototransistors	11-13
AN508 Applications of Phototransistors in Electro-Optic Systems	11-24
AN561 How to Use Photosensors and Light Sources	11-38
AN571A Isolation Techniques Using Optical Couplers	11-43
AN780A Applications of the MOC3011 Triac Driver	11-51
AN846 Basic Concepts of Fiber Optics and Fiber Optic Communications	11-57
AN982 Applications of Zero Voltage Crossing Optically Isolated Triac Drivers	11-79
AN1016 Infrared Sensing and Data Transmission	11-89
Optoisolators for Switching Power Supplies ...	11-95
VDE Circuit Board Layout Design Rules	11-97
Application Note Abstracts	11-103

Emitter/Detector Application Circuits

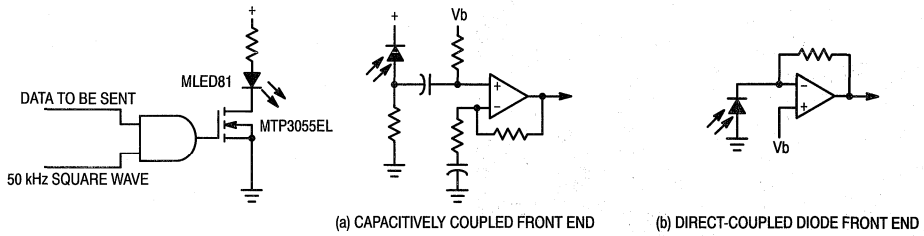

Front-End Amplifier Options

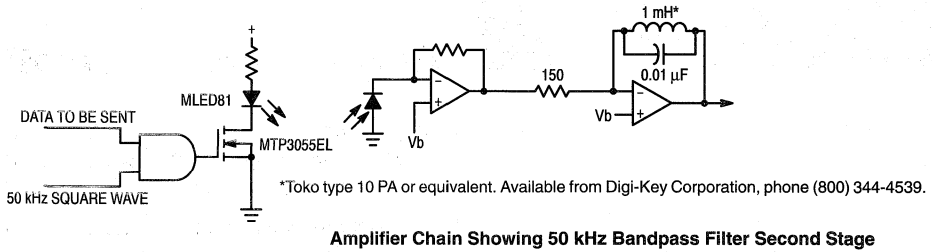
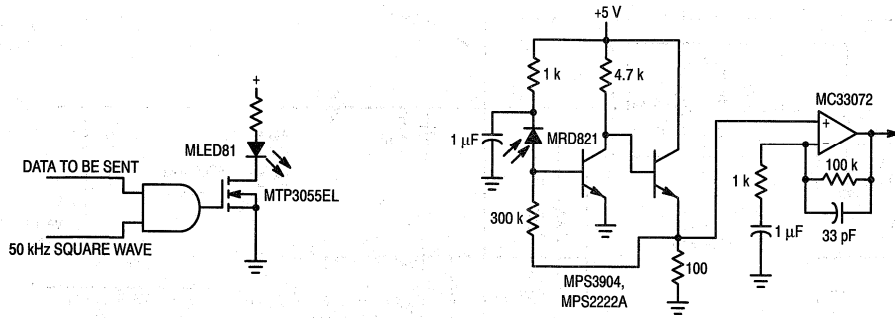
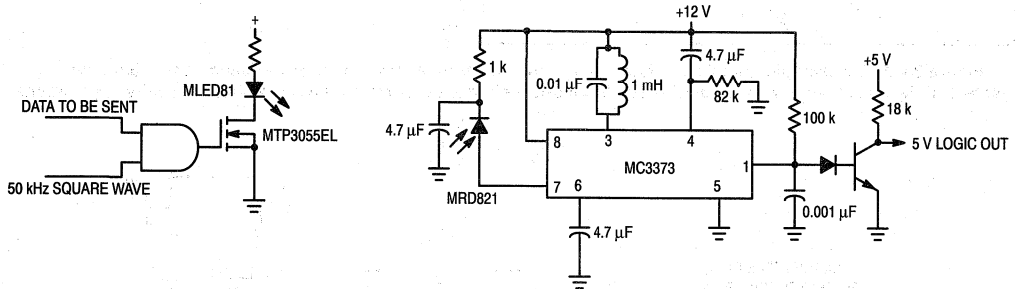

Figure 1. Position Sensing and Motion Sensing in Ambient Light

Emitter/Detector Application Circuits (continued)



Simple Discrete Front End with Op Amp



IR Receiver Using the Integrated MC3373, for Ranges of 10–30 Meters

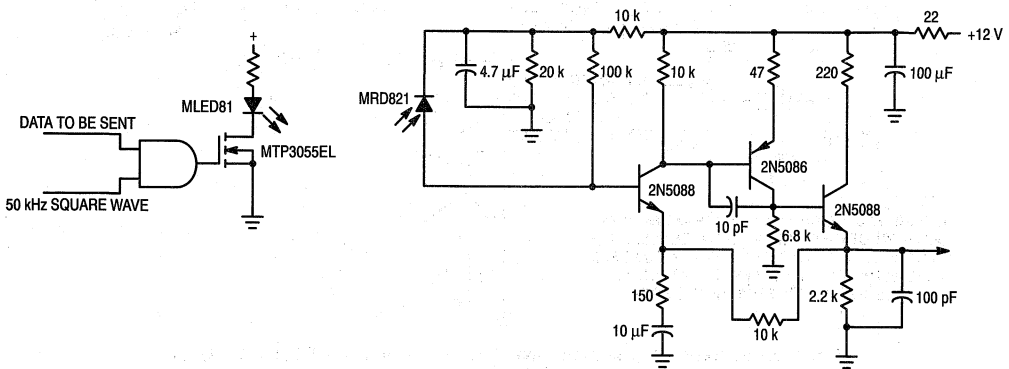

High-Performance Discrete Front-End Amplifier with Special Attention Paid to Noise for Range of up to 100 Meters

Figure 2. Remote Control Applications

Emitter/Detector Application Circuits (continued)

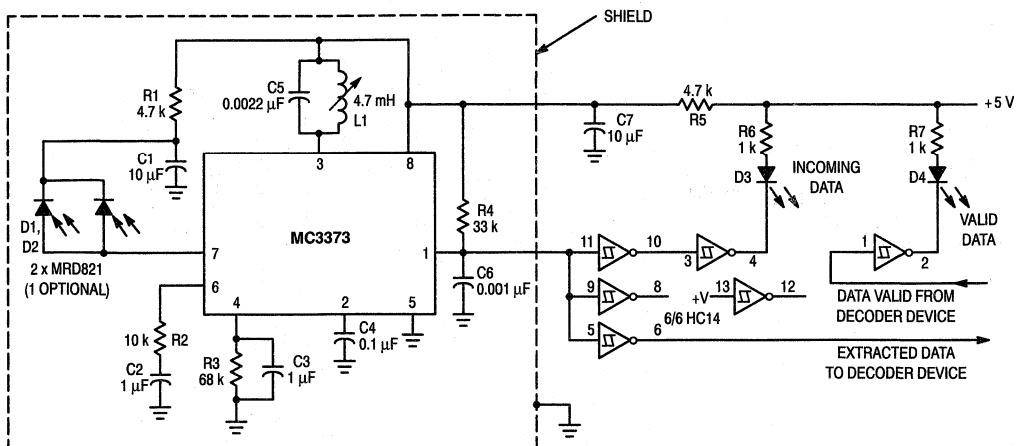

Figure 3a. IR Receiver section: Component values shown are for a 50 kHz carrier frequency and a 5.0 V supply. Note that the use of two receiving diodes as an optional shield is required in all but the shortest range applications.

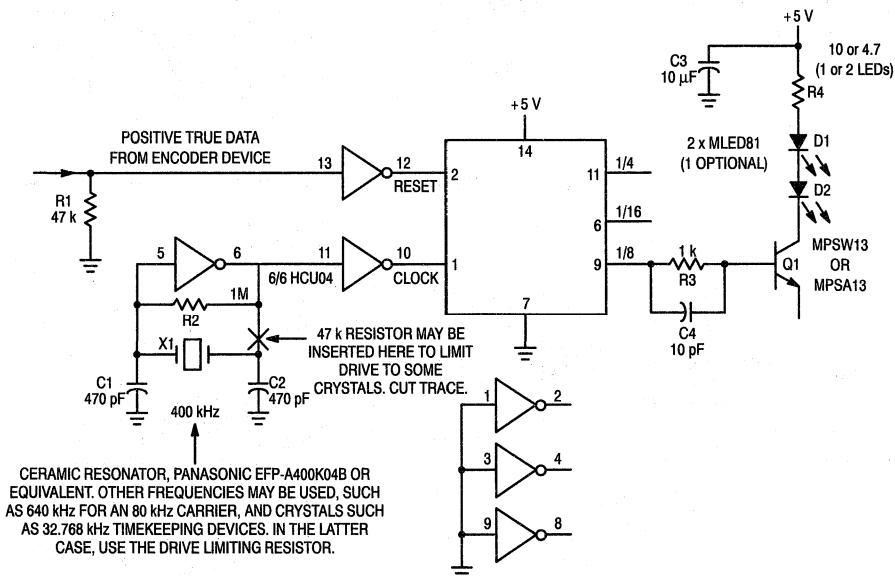

Figure 3b. IR Transmitter section: Note that the use of two IR LEDs is optional. Choose R4 for an LED current appropriate to the application. 250 mA is typical.

Figure 3. IR Remote Control Application

Optoisolator (Transistor Output) Application Circuits

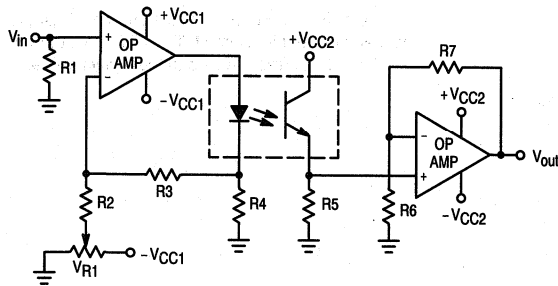

Figure 1. Isolation Amplifier

The circuit in Figure 1 is a non-modulated isolation amplifier that operates with low-frequency signals. The optoisolator input is biased by a DC forward current superimposed on a low-frequency signal. The DC bias current is adjusted by VR.

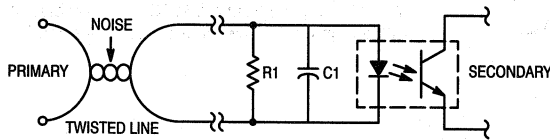
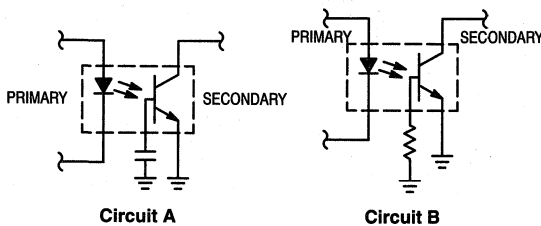

Figure 2. Noise Protection Circuits

The circuit in Figure 2 includes the parallel connection of a Resistor (R1) and capacitor (C1) across the input of the optoisolator useful when relatively long signal lines are connected (i.e. between a computer & terminal). The larger the value of C1 the more the effect, with a sacrifice to signal propagation.



Circuit A

Circuit B

Figure 3. Noise Protection Circuits

In Figure 3, Circuit A is effective against noise, but sacrifices response time. Circuit B is also effective against noise with a sacrifice in CTR due to the base resistor. If the optoisolator is operated in a switching mode, it is best to use isolators without the base-chip to pin connection (i.e. MOC8101 series).

Optoisolator (Transistor Output) Application Circuits (continued)

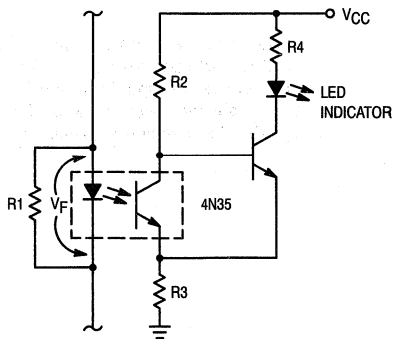

Figure 4. Current Monitor Circuit

The circuit in Figure 4 is designed to detect any leakage current in a circuit. The LED indicator turns on if the leak current exceeds the V_F/R_1 value.

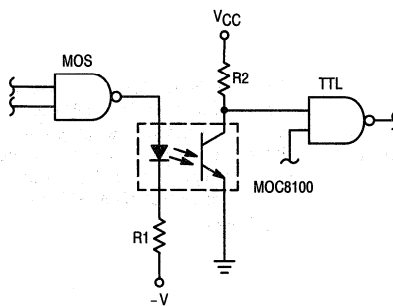

Figure 5. Level Conversion Circuit

The circuit in Figure 5 shows a simple level converter using an optoisolator. This circuit converts the MOS level to TTL levels. Because of the small currents supplied from the MOS IC, an optoisolator with a high CTR at low input current is required.

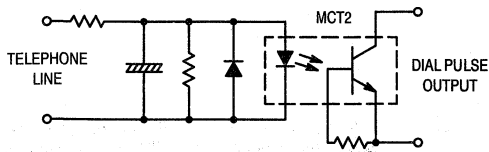
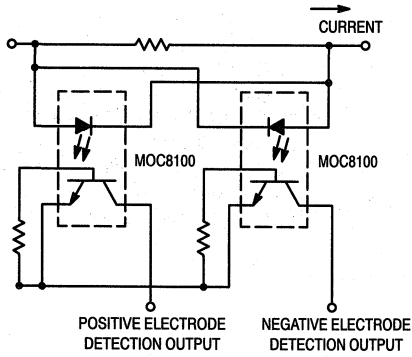

Figure 6. Dial Pulse Monitor Circuit

The circuit in Figure 6 shows an optoisolator that is actuated by dial pulse currents when connected to the telephone line. The output is used as a dial pulse monitor.

Optoisolator (Transistor Output) Application Circuits (continued)



The circuit in Figure 7 shows an example of an optoisolator used to detect the polarity on a telephone line.

Figure 7. Telephone Line Polarity Detection Circuit

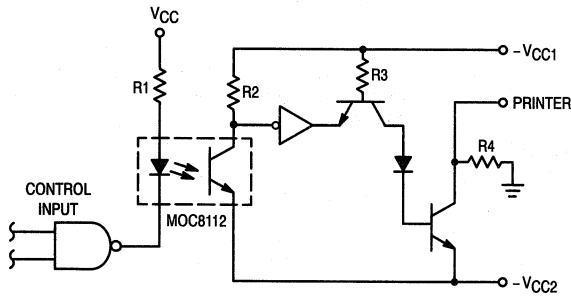

The circuit in Figure 8 shows an electrostatic printer control circuit utilizing an optoisolator. The high voltage print head driving circuit is optically isolated from the low voltage control input.

Figure 8. Print Head Circuit Control

Optoisolator (AC Input/Transistor Output) Application Circuits

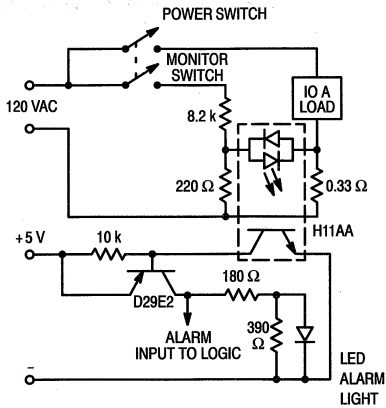

Figure 1. Load Monitor and Alarm

The circuit in Figure 1 is a simple AC power monitor that will light an alarm lamp and provide a "1" input to a microprocessor if either of the following occurs:

- 1) Load dropout due to filament burn out, fusing, etc.
- 2) Uncalled for load power due to switch failure.

The optoisolator provides complete electrical isolation between logic and power levels.

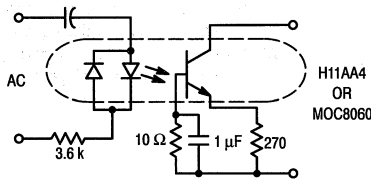

Figure 2. Ring Detector

The circuit in Figure 2 will detect the presence of an incoming ring signal causing the output transistor to be turned on.

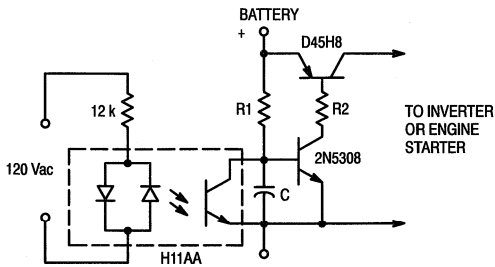

Figure 3. UPS Solid State Turn-On Switch

The circuit in Figure 3 detects when the 120 Vac power line is interrupted causing the output transistor to turn off. This allows C to change and turn on the 2N5308-D45H8 combination which then activates the auxiliary power supply. A fixed number of "dropped cycles" can be ignored by the choice of value C.

Optoisolator (AC Input/Transistor Output) Application Circuits (continued)

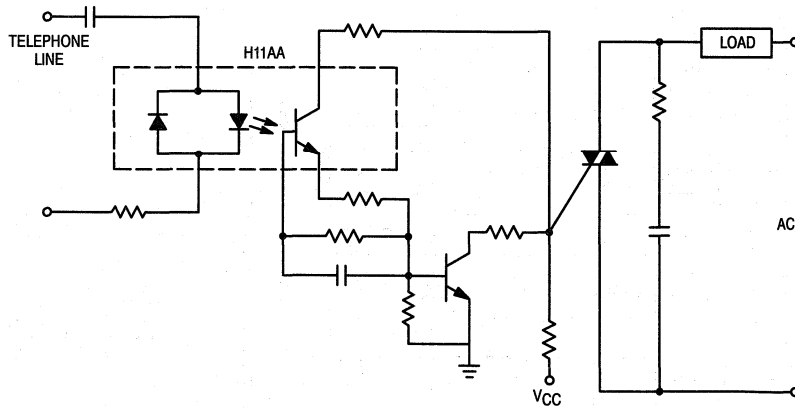

Figure 4. Power Control by Bell Signal Circuit

The circuit in Figure 4 is an application example for ON/OFF switching of AC loads by a telephone bell signal.

Optoisolator (Triac Driver) Application Circuits

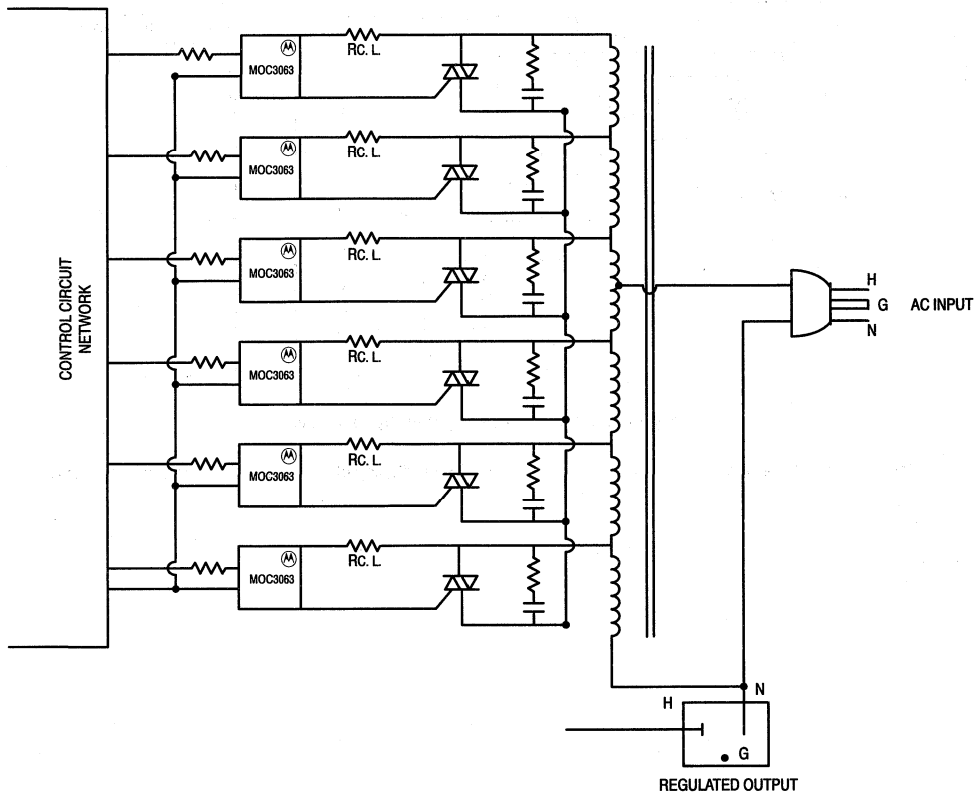

Figure 1. Line Voltage Regulator (Tap Switching)

- Step Up or Step Down Regulation
- Regulated up to 240 Vac
- Isolated Control Network Built-In
- Zero Crossing Control Limiting Current Surges

Optoisolator (Triac Driver) Application Circuits (continued)

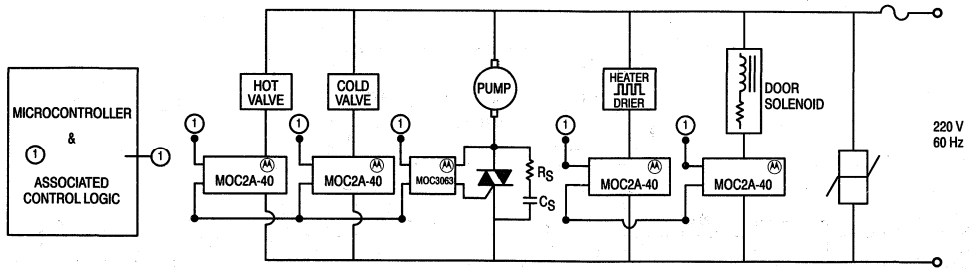

Figure 2. Commercial Appliance Control (Dishwasher/Washing Machine/Dryer) Application

- Microprocessor Controlled and Isolated from AC Power
- Zero-Crossing Protection
 - Limits Surge Currents Protecting Hardware Added
 - Noise Immunity (Passes NEMA 2-230, IEEE472)

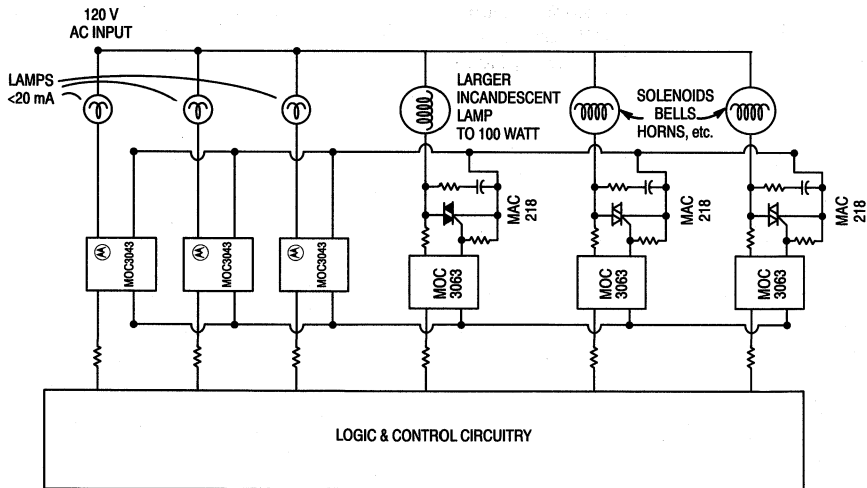

Figure 3. Gaming Machine or Lamp Control Application

- Low Cost Solid-State Control
- Multiple Purpose Zero Cross Switching
- Isolated for Control Circuit Protection

Optoisolator (Triac Driver) Application Circuits (continued)

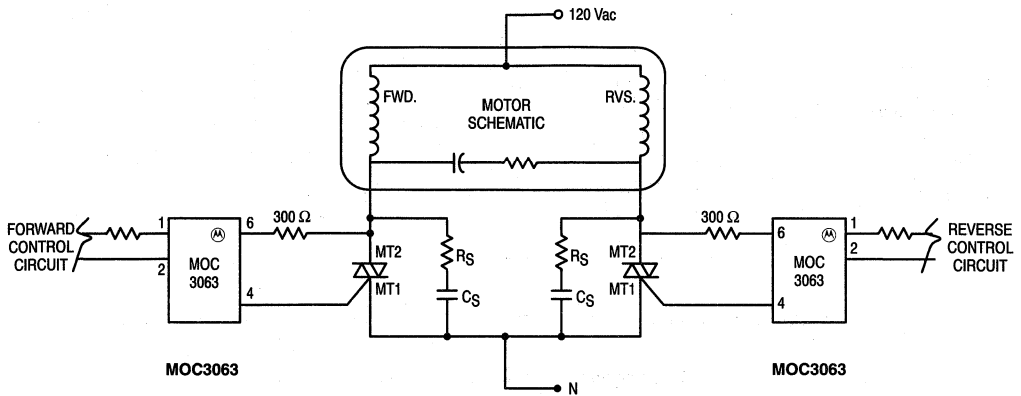

Figure 4. Reversing Motor Application

- Ideal for Up/Down or Forward/Reversing Applications
 - Security Gates
 - Recliner Chairs
 - Hospital Beds
- Zero Crossing Control

THEORY AND CHARACTERISTICS OF PHOTOTRANSISTORS

Prepared By:
John Bliss

INTRODUCTION

Phototransistor operation is based on the sensitivity of a pn junction to radiant energy. If radiant energy of proper wave-length is made to impinge on a junction, the current through that junction will increase. This optoelectronic phenomenon has provided the circuit designer with a device for use in a wide variety of applications. However, to make optimum use of the phototransistor, the designer should have a sound grasp of its operating principles and characteristics.

HISTORY

The first significant relationships between radiation and electricity were noted by Gustav Hertz in 1887. Hertz observed that under the influence of light, certain surfaces were found to liberate electrons.

In 1900, Max Planck proposed that light contained energy in discrete bundles or packets which he called photons. Einstein formulated this theory in 1905, showing that the energy content of each photon was directly proportional to the light frequency:

$$E = hf, \quad (1)$$

where E is the photon energy,
h is Planck's constant, and
f is the light frequency.

Planck theorized that a metal had associated with it a work function, or binding energy for free electrons. If a photon could transfer its energy to a free electron, and that energy exceeded the work function, the electron could be liberated from the surface. The presence of an electric field could enhance this by effectively reducing the work function. Einstein extended Planck's findings by showing that the velocity, and hence the momentum of an emitted electron, depended on the work function and the light frequency.

PHOTO EFFECT IN SEMICONDUCTORS

Bulk Crystal

If light of proper wavelength impinges on a semiconductor crystal, the concentration of charge carriers is found to increase. Thus, the crystal conductivity will increase:

$$\sigma = q (\mu_e n + \mu_h p), \quad (2)$$

where σ is the conductivity,
q is the electron charge,
 μ_e is the electron mobility,
 μ_h is the hole mobility,
n is the electron concentration, and
p is the hole concentration.

The process by which charge-carrier concentration is increased is shown in Figure 1. The band structure of the semiconductor is shown, with an energy gap, or forbidden region, of E_g electron volts. Radiation from two light sources is shown striking the crystal. Light frequency f_1 is sufficiently high that its photon energy, hf_1 , is slightly greater than the energy gap. This energy is transferred to a bound electron at site one in the valence band, and the electron is excited to a higher energy level, site one in the conduction band, where it is free to serve as a current carrier. The hole left behind at site one in the valence band is also free to serve as a current carrier.

The photon energy of the lower-frequency light, hf_2 , is less than the band gap, and an electron freed from site two in the valence band will rise to a level in the forbidden region, only to release this energy and fall back into the valence band and recombine with a hole at site three.

The above discussion implies that the energy gap, E_g , represents a threshold of response to light. This is true, however, it is not an abrupt threshold. Throughout the photo-excitation process, the law of conservation of mo-

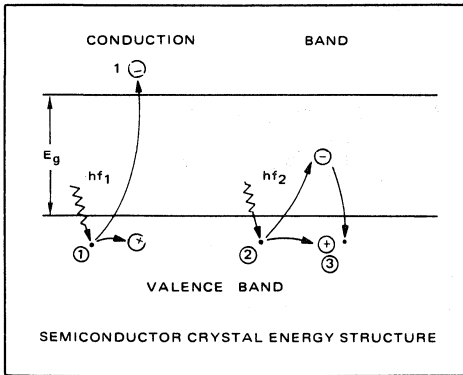

FIGURE 1 - Photoeffect in a Semiconductor

mentum applies. The momentum and density of hole-electron sites are highest at the center of both the valence and conduction bands, and fall to zero at the upper and lower ends of the bands. Therefore, the probability of an excited valence-band electron finding a site of like momentum in the conduction band is greatest at the center of the bands and lowest at the ends of the bands. Consequently, the response of the crystal to the impinging light is found to rise from zero at a photon energy of E_g electron volts, to a peak at some greater energy level, and then to fall to zero again at an energy corresponding to the difference between the bottom of the valence band and the top of the conduction band.

The response is a function of energy, and therefore of frequency, and is often given as a function of reciprocal frequency, or, more precisely, of wave length. An example is shown in Figure 2 for a crystal of cadmium-selenide. On the basis of the information given so far, it would seem reasonable to expect symmetry in such a curve; however, trapping centers and other absorption phenomena affect the shape of the curve¹.

The optical response of a bulk semiconductor can be modified by the addition of impurities. Addition of an acceptor impurity, which will cause the bulk material to become p-type in nature, results in impurity levels which lie somewhat above the top of the valence band. Photo-excitation can occur from these impurity levels to the conduction band, generally resulting in a shifting and reshaping of the spectral response curve. A similar modification of response can be attributed to the donor impurity levels in n-type material.

PN Junctions

If a pn junction is exposed to light of proper frequency, the current flow across the junction will tend to increase. If the junction is forward-biased, the net increase will be relatively insignificant. However, if the junction is reverse-biased, the change will be quite appreciable. Figure 3 shows the photo effect in the junction for a frequency well within the response curve for the device.

Photons create hole-electron pairs in the crystal on both sides of the junction. The transferred energy promotes the electrons into the conduction band, leaving the holes in the valence band. The applied external bias provides an electric field, \mathcal{E} , as shown in the figure. Thus the photo-induced electrons in the p-side conduction band will flow down the potential hill at the junction into the n-side and from there to the external circuit. Likewise, holes in the valence band of the n-side will flow across the junction into the p-side where they will add to the external current.

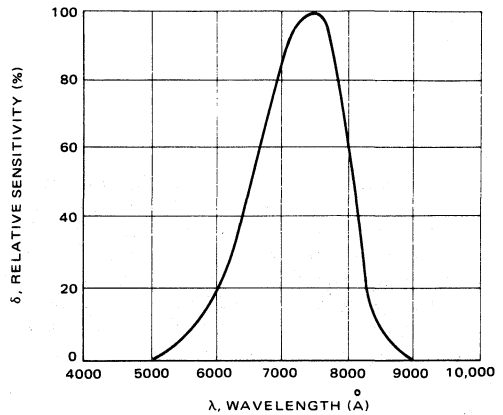

FIGURE 2 - Spectral Response of Cadmium Selenide

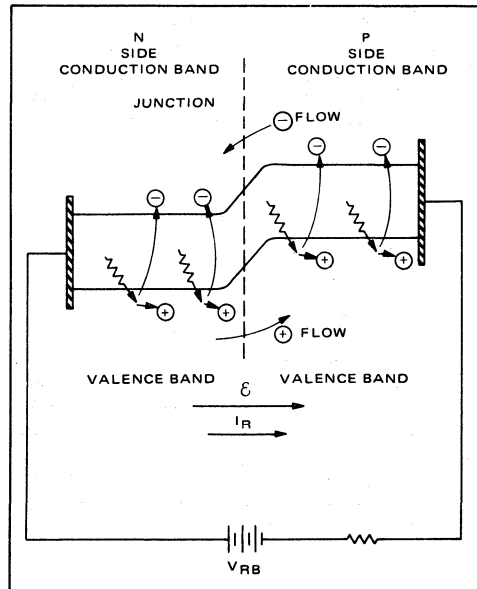

FIGURE 3 - Photo Effect in a Reverse-Biased PN Junction

1. See references for a detailed discussion of these.

Under dark conditions, the current flow through the reverse-biased diode is the reverse saturation current, I_0 . This current is relatively independent of the applied voltage (below breakdown) and is basically a result of the thermal generation of hole-electron pairs.

When the junction is illuminated, the energy transferred from photons creates additional hole-electron pairs. The number of hole-electron pairs created is a function of the light intensity.

For example, incident monochromatic radiation of H (watts/cm²) will provide P photons to the diode:

$$P = \frac{\lambda H}{hc}, \quad (3)$$

where λ is the wavelength of incident light,

h is Planck's constant, and

c is the velocity of light.

The increase in minority carrier density in the diode will depend on P , the conservation of momentum restriction, and the reflectance and transmittance properties of the crystal. Therefore, the photo current, I_{λ} , is given by

$$I_{\lambda} = \eta F q A, \quad (4)$$

where η is the quantum efficiency or ratio of current carriers to incident photons,

F is the fraction of incident photons transmitted by the crystal,

q is the charge of an electron, and

A is the diode active area.

Thus, under illuminated conditions, the total current flow is

$$I = I_0 + I_{\lambda}. \quad (5)$$

If I_{λ} is sufficiently large, I_0 can be neglected, and by using the spectral response characteristics and peak spectral sensitivity of the diode, the total current is given approximately by

$$I \approx \delta SRH, \quad (6)$$

where δ is the relative response and a function of radiant wavelength,

SR is the peak spectral sensitivity, and

H is the incident radiation.

The spectral response for a silicon photo-diode is given in Figure 4.

Using the above relations, an approximate model of the diode is given in Figure 5. Here, the photo and thermally generated currents are shown as parallel current sources. C represents the capacitance of the reverse-biased junction while G represents the equivalent shunt conductance of the diode and is generally quite small. This model applies only for reverse bias, which, as mentioned above, is the normal mode of operation.

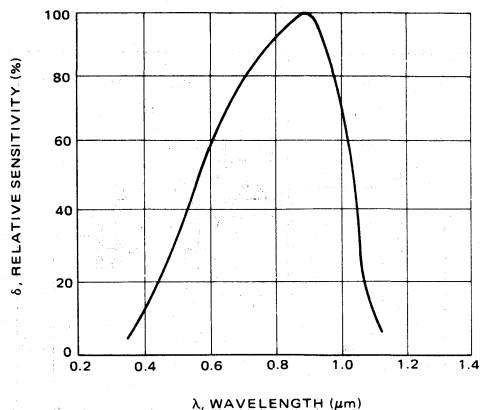

FIGURE 4 – Spectral Response of Silicon Photodiode

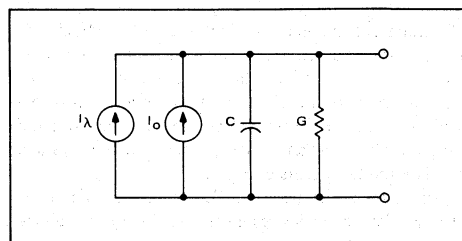

FIGURE 5 – Approximate Model of Photodiode

Photo Transistor

If the pn junction discussed above is made the collector-base diode of a bipolar transistor, the photo-induced current is the transistor base current. The current gain of the transistor will thus result in a collector-emitter current of

$$I_C = (h_{fe} + 1) I_{\lambda}, \quad (7)$$

where I_C is the collector current,

h_{fe} is the forward current gain, and

I_{λ} is the photo induced base current.

The base terminal can be left floating, or can be biased up to a desired quiescent level. In either case, the collector-base junction is reverse biased and the diode current is the reverse leakage current. Thus, photo-stimulation will result in a significant increase in diode, or base current, and with current gain will result in a significant increase in collector current.

The energy-band diagram for the photo transistor is shown in Figure 6. The photo-induced base current is returned to the collector through the emitter and the external circuitry. In so doing, electrons are supplied to the base region by the emitter where they are pulled into the collector by the electric field \mathcal{E} .

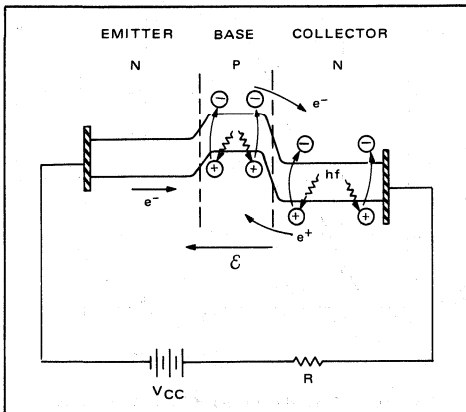

FIGURE 6 - Photoeffect in a Transistor

The model of the photo diode in Figure 5 might also be applied to the phototransistor, however, this would be severely limited in conveying the true characteristics of the transistor. A more useful and accurate model can be obtained by using the hybrid-pi model of the transistor and adding the photo-current generator between collector and base. This model appears in Figure 7.

Assuming a temperature of 25°C, and a radiation source at the wave length of peak response (i.e., $\delta = 1$), the following relations apply:

$$I_{\lambda} \approx S_{RCBO} \cdot H, \tag{8a}$$

$$g_m = 40 i_c, \text{ and} \tag{8b}$$

$$r_{be} = h_{fe}/g_m. \tag{8c}$$

where S_{RCBO} is the collector-base diode radiation sensitivity with open emitter,

g_m is the forward transconductance,

i_c is the collector current, and

r_{be} is the effective base-emitter resistance.

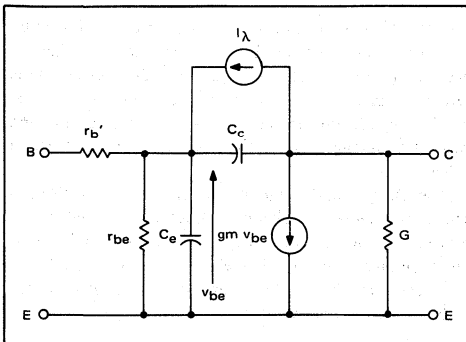

FIGURE 7 - Hybrid-pi Model of Phototransistor

In most cases $r'_{b'} \ll r_{be}$, and can be neglected. The open-base operation is represented in Figure 8. Using this model, a feel for the high-frequency response of the device may be obtained by using the relationship

$$f_t \approx \frac{g_m}{2\pi C_e}, \tag{9}$$

where f_t is the device current-gain-bandwidth product.

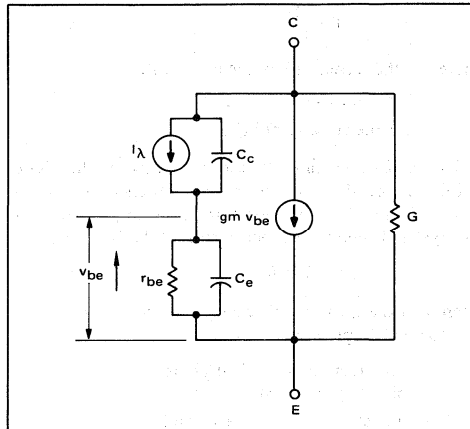

FIGURE 8 - Floating Base Approximate Model of Phototransistor

STATIC ELECTRICAL CHARACTERISTICS OF PHOTOTRANSISTORS

Spectral Response

As mentioned previously, the spectral response curve provides an indication of a device's ability to respond to radiation of different wave lengths. Figure 9 shows the spectral response for constant energy radiation for the Motorola MRD300 phototransistor series. As the figure indicates, peak response is obtained at about 8000 Å (Angstroms), or 0.8 μm.

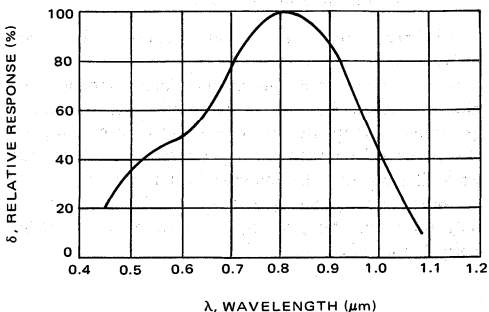

FIGURE 9 - Constant Energy Spectral Response for MRD300

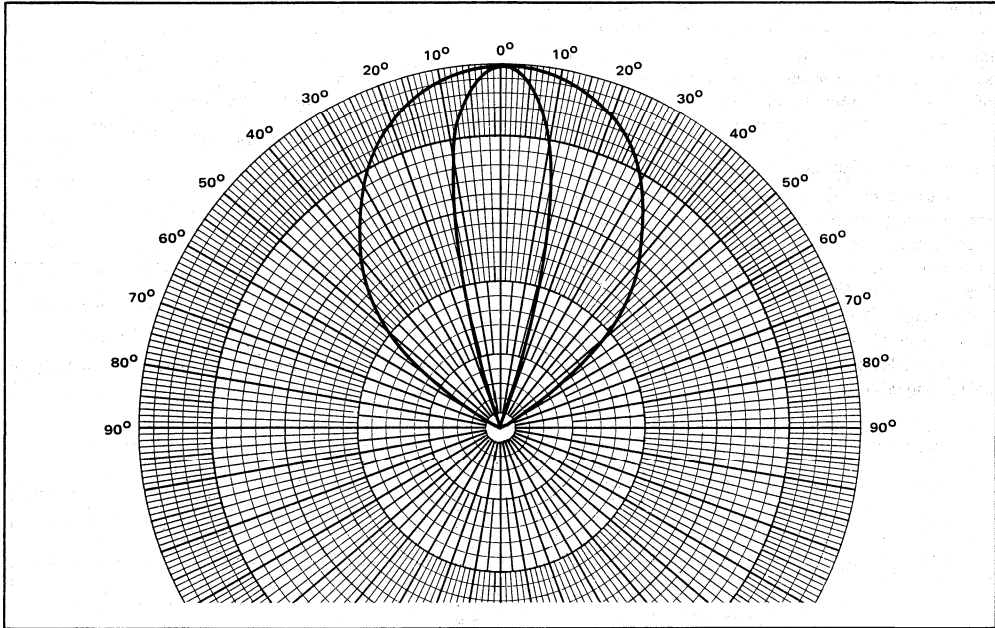

FIGURE 10 – Polar Response of MRD300. Inner Curve with Lens, Outer Curve with Flat Glass.

Angular Alignment

Lambert's law of illumination states that the illumination of a surface is proportional to the cosine of the angle between the normal to the surface and the direction of the radiation. Thus, the angular alignment of a photo-transistor and radiation source is quite significant. The cosine proportionality represents an ideal angular response. The presence of an optical lens and the limit of window size further affect the response. This information is best conveyed by a polar plot of the device response. Such a plot in Figure 10 gives the polar response for the MRD300 series.

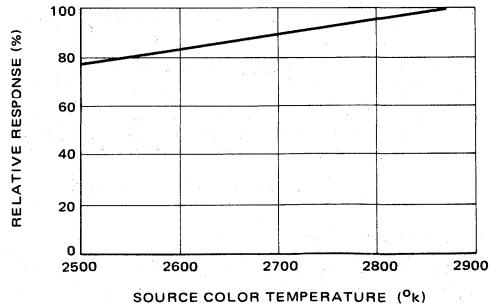

FIGURE 12 – Relative Response of MRD300 versus Color Temperature

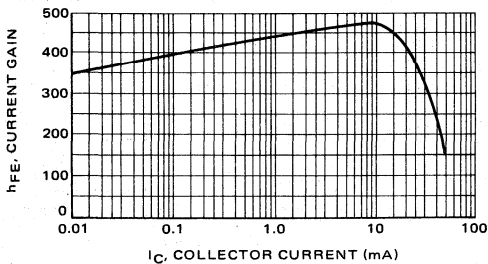

FIGURE 11 – DC Current Gain versus Collector Current

DC Current Gain

The sensitivity of a photo transistor is a function of the collector-base diode quantum efficiency and also of the dc current gain of the transistor. Therefore, the overall sensitivity is a function of collector current. Figure 11 shows the collector current dependence of dc current gain.

Color Temperature Response

In many instances, a photo transistor is used with a broad band source of radiation, such as an incandescent lamp. The response of the photo transistor is therefore dependent on the source color temperature. Incandescent

sources are normally operated at a color temperature of 2870°K, but, lower-color-temperature operation is not uncommon. It therefore becomes desirable to know the result of a color temperature difference on the photo sensitivity. Figure 12 shows the relative response of the MRD300 series as a function of color temperature.

Temperature Coefficient of I_p

A number of applications call for the use of photo-transistors in temperature environments other than normal room temperature. The variation in photo current with temperature changes is approximately linear with a positive slope of about 0.667%/°C.

The magnitude of this temperature coefficient is primarily a result of the increase in hFE versus temperature, since the collector-base photo current temperature coefficient is only about 0.1%/°C.

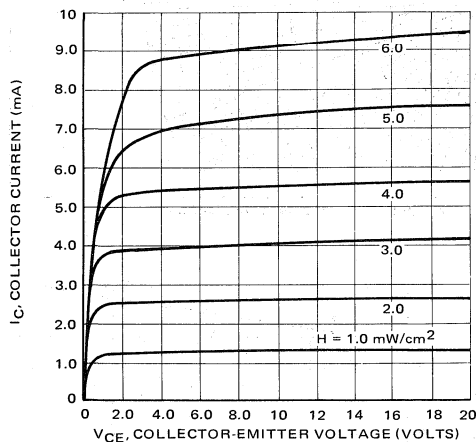

FIGURE 13 – Collector Characteristics for MRD300

Collector Characteristics

Since the collector current is primarily a function of impinging radiation, the effect of collector-emitter voltage, below breakdown, is small. Therefore, a plot of the I_C - V_{CE} characteristics with impinging radiation as a parameter, are very similar to the same characteristics with I_B as a parameter. The collector family for the MRD300 series appears in Figure 13.

Radiation Sensitivity

The capability of a given phototransistor to serve in a given application is quite often dependent on the radiation sensitivity of the device. The open-base radiation sensitivity for the MRD300 series is given in Figure 14. This indicates that the sensitivity is approximately linear with respect to impinging radiation. The additional capability of the MRD300 to be pre-biased gives rise to interest in the sensitivity as a function of equivalent base resistance. Figure 15 gives this relationship.

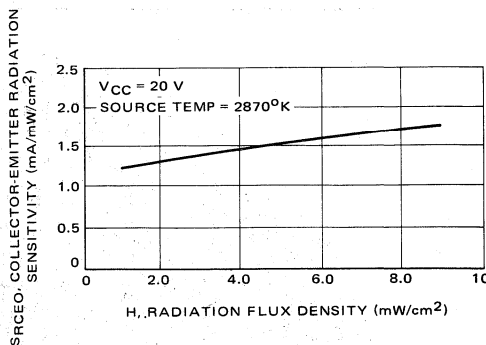

FIGURE 14 – Open Base Sensitivity versus Radiation for MRD300

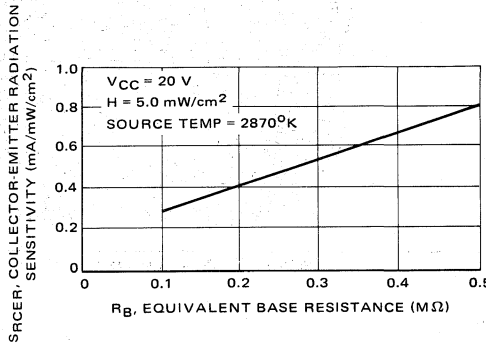

FIGURE 15 – Effect of Base Resistance on Sensitivity of MRD300

Capacitance

Junction capacitance is the significant parameter in determining the high frequency capability and switching speed of a transistor. The junction capacitances of the MRD300 as a function of junction voltages are given in Figure 16.

DYNAMIC CHARACTERISTICS OF PHOTOTRANSISTORS

Linearity

The variation of hFE with respect to collector current results in a non-linear response of the photo transistor over

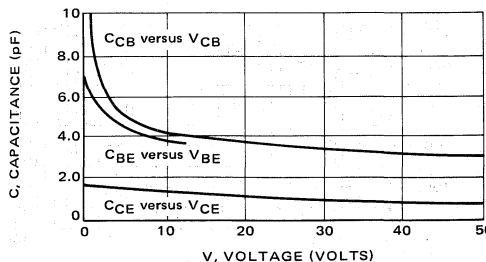

FIGURE 16 – Junction Capacitances versus Voltage for MRD300

large signal swings. However, the small-signal response is approximately linear. The use of a load line on the collector characteristic of Figure 13 will indicate the degree of linearity to be expected for a specific range of optical drive.

Frequency Response

The phototransistor frequency response, as referred to in the discussion of Figures 7 and 8, is presented in Figure 17. The device response is flat down to dc with the rolloff frequency dependent on the load impedance as well as on the device. The response is given in Figure 17 as the 3-dB frequency as a function of load impedance for two values of collector current.

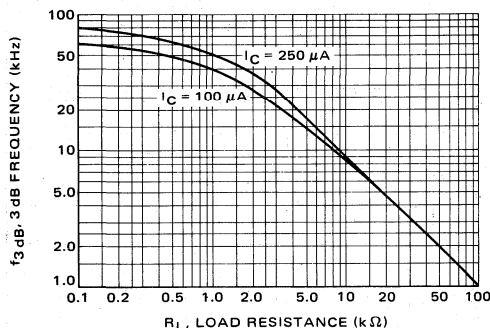

FIGURE 17 — 3 dB Frequency versus Load Resistance for MRD300

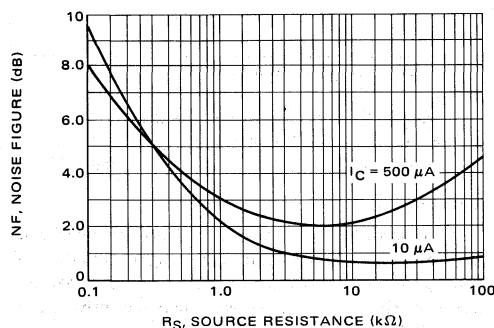

FIGURE 18 — MRD300 Noise Figure versus Source Resistance

Noise Figure

Although the usual operation of the phototransistor is in the floating base mode, a good qualitative feel for the device's noise characteristic can be obtained by measuring noise figure under standard conditions. The 1 kHz noise figure for the MRD300 is shown in Figure 18.

Small Signal h Parameters

As with noise figure, the small-signal h-parameters, measured under standard conditions, give a qualitative feel for

the device behavior. These are given as functions of collector current in Figure 19. With this information, the device can be analyzed in the standard hybrid model of Figure 20(a); by use of the conversions of Table I, the equivalent r-parameter model of Figure 20(b) can be used.

TABLE I — Parameter Conversions

$$h_{fb} = \frac{h_{fe}}{1 + h_{fe}}$$

$$r_c = \frac{h_{fe} + 1}{h_{oe}}$$

$$r_e = \frac{h_{re}}{h_{oe}}$$

$$r_b = h_{ie} - \frac{h_{re}(1 + h_{fe})}{h_{oe}}$$

SWITCHING CHARACTERISTICS OF PHOTOTRANSISTORS

In switching applications, two important requirements of a transistor are:

- (1) speed
- (2) ON voltage

Since some optical drives for phototransistors, can provide fast light pulses, the same two considerations apply.

Switching Speed

If reference is made to the model of Figure 8, it can be seen that a fast rise in the current I_λ will not result in an equivalent instantaneous increase in collector-emitter current. The initial flow of I_λ must supply charging current to C_{CB} and C_{BE} . Once these capacitances have been charged, I_λ will flow through r_{be} . Then the current generator, $g_m \cdot v_{be}$, will begin to supply current. During turn-off, a similar situation occurs. Although I_λ may instantaneously drop to zero, the discharge of C_{CB} and C_{BE} through r_{be} will maintain a current flow through the collector. When the capacitances have been discharged, V_{be} will fall to zero and the current, $g_m \cdot V_{be}$, will likewise drop to zero. (This discussion assumes negligible leakage currents). These capacitances therefore result in turn-on and turn-off delays, and in rise and fall times for switching applications just as found in conventional bipolar switching transistors. And, just as with conventional switching, the times are a function of drive. Figure 21 shows the collector current (or drive) dependence of the turn-on delay and rise times. As indicated the delay time is dependent on the device only; whereas the rise-time is dependent on both the device and the load.

If a high-intensity source, such as a xenon flash lamp, is used for the optical drive, the device becomes optically saturated unless large optical attenuation is placed between source and detector. This can result in a significant storage time during the turn off, especially in the floating-base mode since stored charge has no direct path out of the

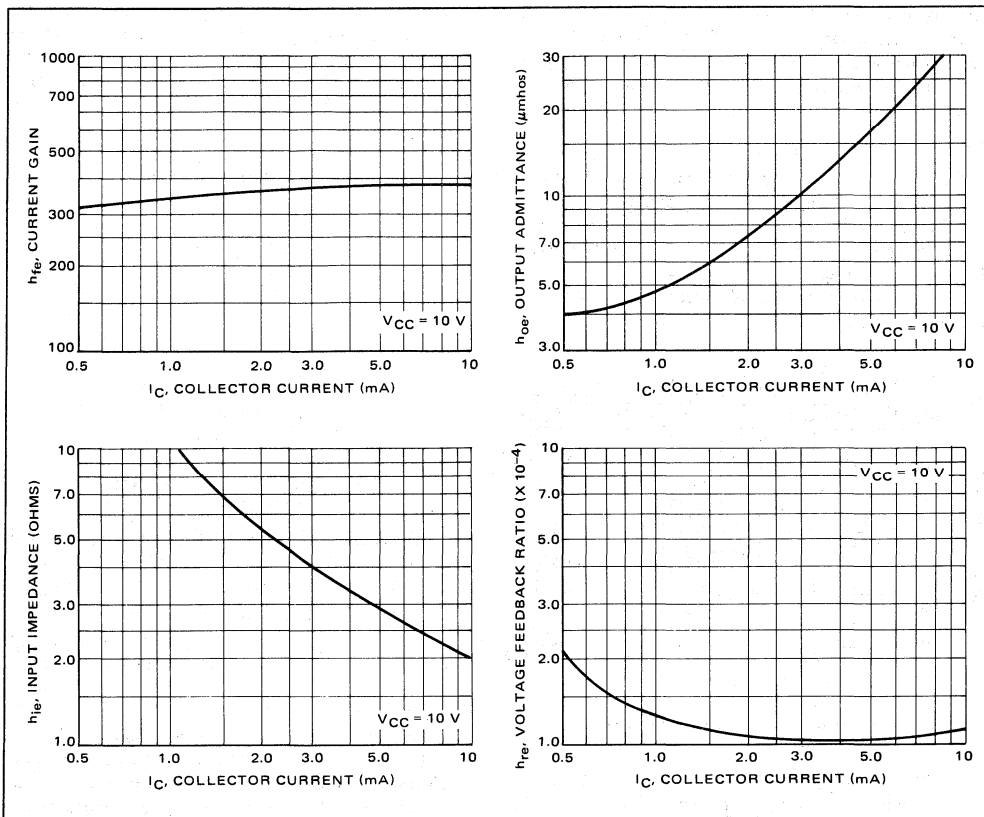

FIGURE 19 - 1 kHz h-Parameters versus Collector Current for MRD300

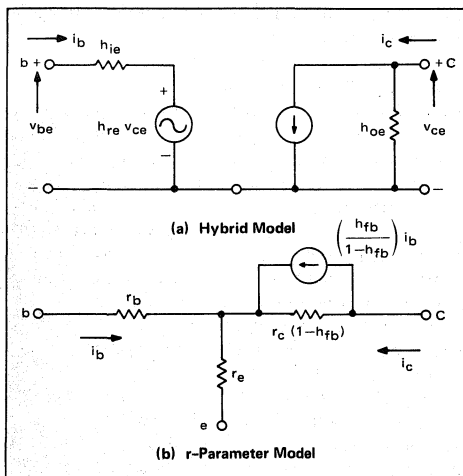

FIGURE 20 - Low Frequency Analytical Models of Phototransistor Without Photo Current Generator

base region. However, if a non-saturating source, such as a GaAs diode, is used for switching drive, the storage, or turn-off delay time is quite low as shown in Figure 22.

Saturation Voltage

An ideal switch has zero ON impedance, or an ON voltage drop of zero. The ON saturation voltage of the MRD300 is relatively low, approximately 0.2 volts. For a given collector current, the ON voltage is a function of drive, and is shown in Figure 23.

APPLICATIONS OF PHOTOTRANSISTORS

As mentioned previously, the phototransistor can be used in a wide variety of applications. Figure 24 shows two phototransistors in a series-shunt chopper circuit. As Q1 is switched ON, Q2 is OFF, and when Q1 is switched OFF, Q2 is driven ON.

Logic circuitry featuring the high input/output electrical isolation of photo transistors is shown in Figure 25.

Figure 26 shows a linear application of the phototransistor. As mentioned previously, the linearity is obtained for small-signal swings.

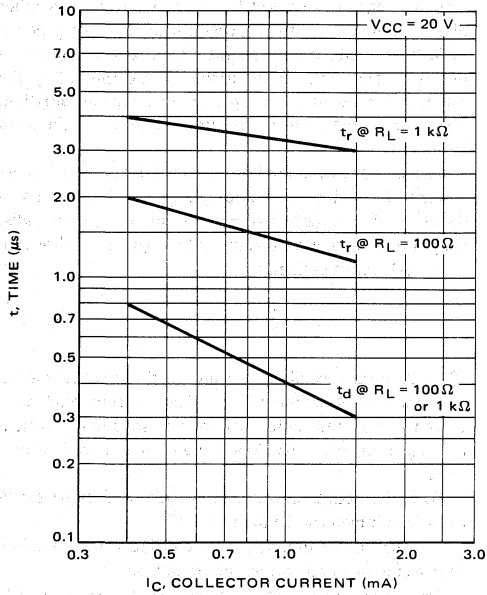

FIGURE 21 – Switching Delay and Rise Times for MRD300

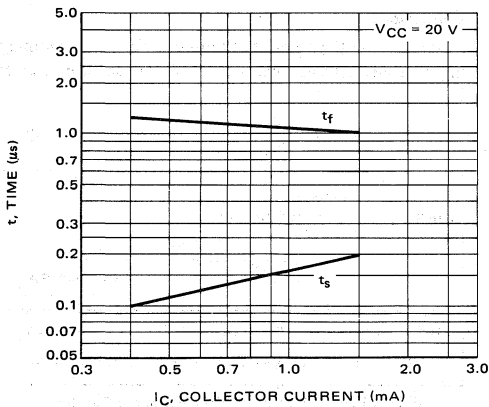

FIGURE 22 – Switching Storage and Fall Times for MRD300

A double-pole, single-throw relay is shown in Figure 27. In general, the phototransistor can be used in counting circuitry, level indications, alarm circuits, tachometers, and various process controls.

Conclusion

The phototransistor is a light-sensitive active device of moderately high sensitivity and relatively high speed. Its response is both a function of light intensity and wavelength, and behaves basically like a standard bipolar transistor with an externally controlled collector-base leakage current.

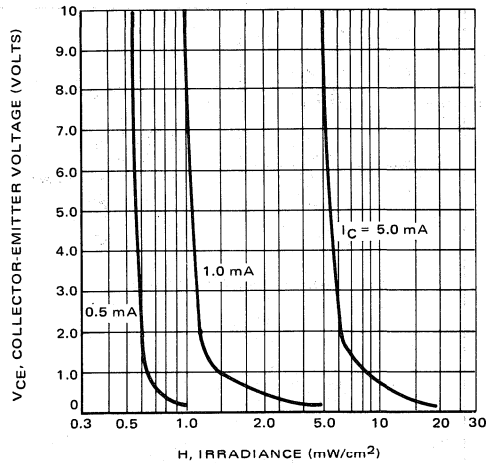

FIGURE 23 – Collector-Emitter Saturation Voltage as a Function of Irradiance for MRD300

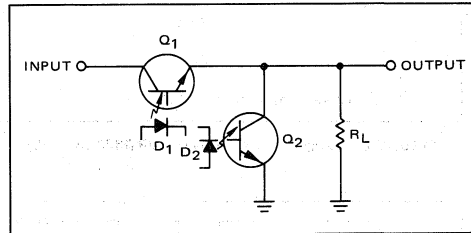

FIGURE 24 – Series-Shunt Chopper Circuit Using MRD300 Phototransistors and GaAs Light Emitting Diodes (LEDs)

APPENDIX I

Radiant energy covers a broad band of the electromagnetic spectrum. A relatively small segment of the band is the spectrum of visible light. A portion of the electromagnetic spectrum including the range of visible light is shown in Figure I-1.

The portion of radiant flux, or radiant energy emitted per unit time, which is visible is referred to as luminous flux. This distinction is due to the inability of the eye to respond equally to like power levels of different visible wavelengths. For example, if two light sources, one green and one blue are both emitting like wattage, the eye will perceive the green light as being much brighter than the blue. Consequently, when speaking of visible light of varying color, the watt becomes a poor measure of brightness. A more meaningful unit is the lumen. In order to obtain a clear understanding of the lumen, two other definitions are required.

The first of these is the standard source (Fig. I-2). The standard source, adopted by international agreement, con-

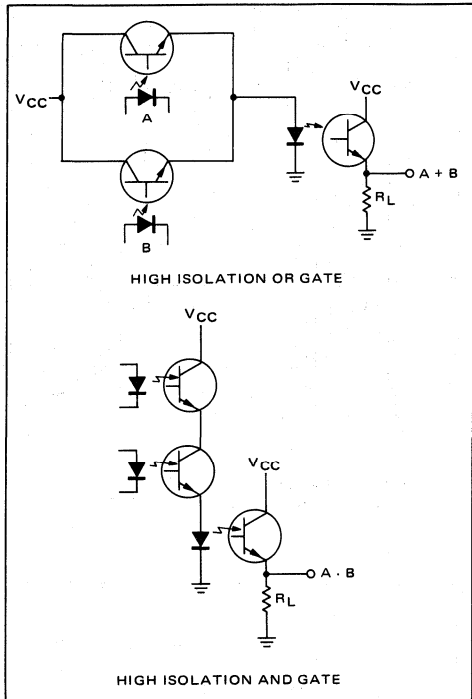

FIGURE 25 — Logic Circuits Using the MRD300 and LEDs

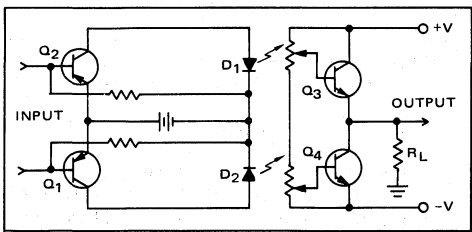

FIGURE 26 — Small Signal Linear Amplifier Using MRD300 and LEDs

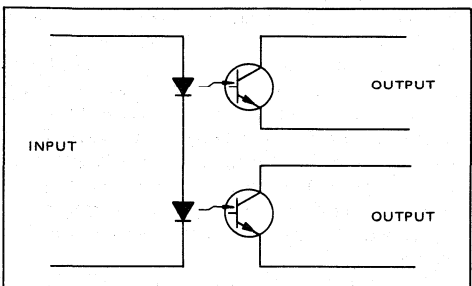

FIGURE 27 — DPST Relay Using MRD300s and LEDs

sists of a segment of fused thoria immersed in a chamber of platinum. When the platinum is at its melting point, the light emitted from the chamber approximates the radiation of a black body. The luminous flux emitted by the source is dependent on the aperture and cone of radiation. The cone of radiation is measured in terms of the solid angle.

The concept of a solid angle comes from spherical geometry. If a point is enclosed by a spherical surface and a set of radial lines define an area on the surface, the radial lines also subtend a solid angle. This angle, ω , is shown in Figure I-3, and is defined as

$$\omega = \frac{A}{r^2}, \quad (I-1)$$

where A is the described area and r is the spherical radius.

If the area A is equal to r^2 , then the solid angle subtended is one unit solid angle or one steradian, which is nothing more than the three-dimensional equivalent of a radian.

With the standard source and unit solid angle established, the lumen can be defined.

A lumen is the luminous flux emitted from a standard source and included within one steradian.

Using the concept of the lumen, it is now possible to define other terms of illumination.

Illuminance

If a differential amount of luminous flux, dF , is impinging on a differential area, dA , the illuminance, E , is given by

$$E = \frac{dF}{dA}. \quad (I-2)$$

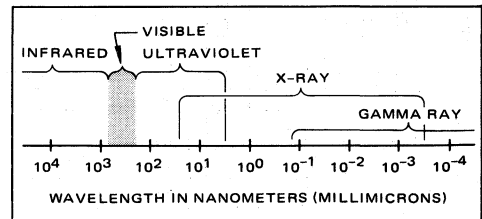

FIGURE I-1 — Portion of Electromagnetic Spectrum

Illuminance is most often expressed in lumens per square foot, or foot-candles. If the illuminance is constant over the area, (I-2) becomes

$$E = F/A. \quad (I-3)$$

Luminous Intensity

When the differential flux, dF , is emitted through a differential solid angle, $d\omega$, the luminous intensity, I , is given by

$$I = \frac{dF}{d\omega}. \quad (I-4)$$

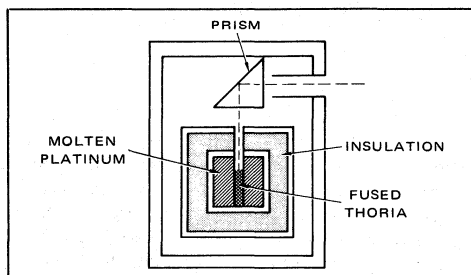

FIGURE I-2 - International Standard Source

Luminous intensity is most often expressed in lumens per steradian or candela. If the luminous intensity is constant with respect to the angle of emission, (I-4) becomes:

$$I = \frac{F}{\omega} \quad (I-5)$$

If the wavelength of visible radiation is varied, but the illumination is held constant, the radiative power in watts will be found to vary. This again illustrates the poor quality of the watt as a measure of illumination. A relation between illumination and radiative power must then be specified at a particular frequency. The point of specification has been taken to be at a wavelength of $0.555 \mu\text{m}$, which is the peak of spectral response of the human eye. At this wavelength, 1 watt of radiative power is equivalent to 680 lumens.

APPENDIX II OPTOELECTRONIC DEFINITIONS

- F, Luminous Flux: Radiant flux of wavelength within the band of visible light.
Lumen: The luminous flux emitted from a standard source and included within one steradian (solid angle equivalent of a radian).
- H, Radiation Flux Density (Irradiance): The total incident radiation energy measured in power per unit area (e.g., mW/cm^2).
- E, Luminous Flux Density (Illuminance): Radiation flux density of wavelength within the band of visible light. Measured in lumens/ ft^2 or foot candles. At the wavelength of peak response of the human eye. $0.555 \mu\text{m}$ ($0.555 \times 10^{-6}\text{m}$), 1 watt of radiative power is equivalent to 680 lumens.
- SR, Radiation Sensitivity: The ratio of photo-induced current to incident radiant energy, the latter measured at the plane of the lens of the photo device.
- SI, Illumination Sensitivity: The ratio of photo-induced current to incident luminous energy, the latter measured at the plane of the lens of the photo device.

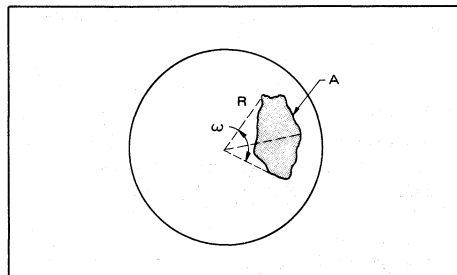
FIGURE I-3 - Solid Angle, ω

Spectral Response: Sensitivity as a function of wavelength of incident energy. Usually normalized to peak sensitivity.

Constants

- Planck's constant: $h = 4.13 \times 10^{-15} \text{ eV}\cdot\text{s}$.
electron charge: $q = 1.60 \times 10^{-19} \text{ coulomb}$.
velocity of light: $c = 3 \times 10^8 \text{ m/s}$.

Illumination Conversion Factors

Multiply	By	To Obtain
lumens/ ft^2	1	ft. candles
lumens/ ft^2 *	1.58×10^{-3}	mW/cm^2
candlepower	4π	lumens

*At $0.555 \mu\text{m}$.

BIBLIOGRAPHY AND REFERENCES

- Fitchen, Franklin C., Transistor Circuit Analysis and Design, D. Van Nostrand Company, Inc., Princeton 1962.
- Hunter, Lloyd P., ed., Handbook of Semiconductor Electronics, Sect 5., McGraw-Hill Book Co., Inc., New York 1962.
- Jordan, A.G. and A.G. Milnes, "Photoeffect on Diffused PN Junctions with Integral Field Gradients", IRE Transactions on Electron Devices, October 1960.
- Millman, Jacob, Vacuum-tube and Semiconductor Electronics, McGraw-Hill Book Co., Inc., New York 1958.
- Sah, C.T., "Effect of Surface Recombination and Channel on PN Junction and Transistor Characteristics", IRE Transactions on Electron Devices, January 1962.
- Sears, F.W. and M.W. Zemansky, University Physics, Addison-Wesley Publishing Co., Inc., Reading, Massachusetts 1962.
- Shockley, William, Electrons and Holes in Semiconductors, D. Van Nostrand Company, Inc., Princeton 1955.

APPLICATIONS OF PHOTOTRANSISTORS IN ELECTRO-OPTIC SYSTEMS

INTRODUCTION

A phototransistor is a device for controlling current flow with light. Basically, any transistor will function as a phototransistor if the chip is exposed to light, however, certain design techniques are used to optimize the effect in a phototransistor.

Just as phototransistors call for special design techniques, so do the circuits that use them. The circuit designer must supplement his conventional circuit knowledge with the terminology and relationships of optics and radiant energy. This note presents the information necessary to supplement that knowledge. It contains a short review of phototransistor theory and characteristics, followed by a detailed discussion of the subjects of irradiance, illuminance, and optics and their significance to phototransistors. A distinction is made between low-frequency/ steady-state design and high-frequency design. The use of the design information is then demonstrated with a series of typical electro-optic systems.

PHOTOTRANSISTOR THEORY¹

Phototransistor operation is a result of the photo-effect in solids, or more specifically, in semiconductors. Light of a proper wavelength will generate hole-electron pairs within the transistor, and an applied voltage will cause these carriers to move, thus causing a current to flow. The intensity of the applied light will determine the number of carrier pairs generated, and thus the magnitude of the resultant current flow.

In a phototransistor the actual carrier generation takes place in the vicinity of the collector-base junction. As shown in Figure 1 for an NPN device, the photo-generated holes will gather in the base. In particular, a hole generated in the base will remain there, while a hole generated in the collector will be drawn into the base by the strong field at the junction. The same process will result in electrons tending to accumulate in the collector. Charge will not really accumulate however, and will try to evenly distribute throughout the bulk regions. Consequently, holes will diffuse across the base region in the direction of the emitter junction. When they reach the junction they will be injected into the emitter. This in turn will cause the emitter to inject electrons into the base. Since the emitter injection efficiency is much larger than the base injection efficiency, each injected hole will result in many injected electrons.

It is at this point that normal transistor action will occur. The emitter injected electrons will travel across the base and be drawn into the collector. There, they will combine with the photo-induced electrons in the collector to appear as the terminal collector current.

Since the actual photogeneration of carriers occurs in the collector base region, the larger the area of this region, the more carriers are generated, thus, as Figure 2 shows, the transistor is so designed to offer a large area to impinging light.

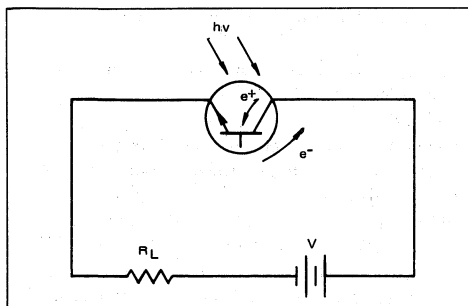

FIGURE 1 — Photo-Generated Carrier Movement in a Phototransistor

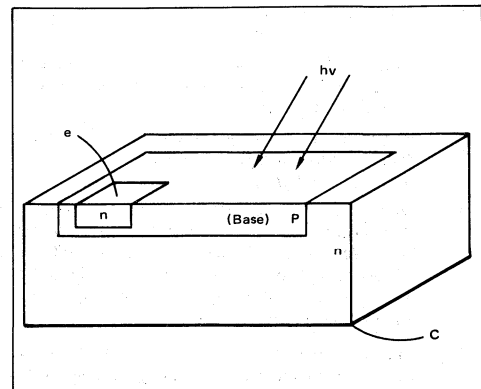

FIGURE 2 — Typical Double-Diffused Phototransistor Structure

¹For a detailed discussion see Motorola Application Note AN-440, "Theory and Characteristics of Phototransistors."

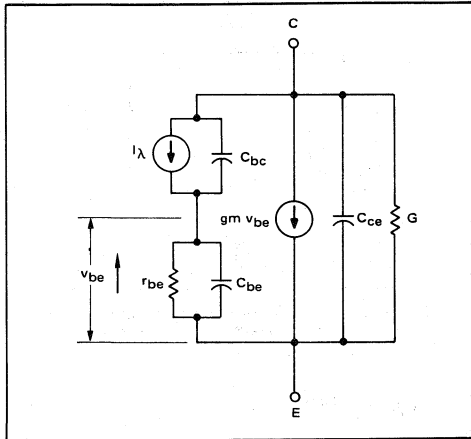

FIGURE 3 – Floating Base Approximate Model of Phototransistor

PHOTOTRANSISTOR STATIC CHARACTERISTICS

A phototransistor can be either a two-lead or a three-lead device. In the three-lead form, the base is made electrically available, and the device may be used as a standard bipolar transistor with or without the additional capability of sensitivity to light. In the two-lead form the base is not electrically available, and the transistor can only be used with light as an input. In most applications, the only drive to the transistor is light, and so the two-lead version is the most prominent.

As a two-lead device, the phototransistor can be modeled as shown in Figure 3. In this circuit, current generator I_λ represents the photo generated current and is approximately given by

$$I_\lambda = \eta F q A \quad (1)$$

where

η is the quantum efficiency or ratio of current carriers to incident photons,

F is the fraction of incident photons transmitted by the crystal,

q is the electronic charge, and

A is the active area.

The remaining elements should be recognized as the component distribution in the hybrid-pi transistor model. Note that the model of Figure 3 indicates that under dark conditions, I_λ is zero and so v_{be} is zero. This means that the terminal current $I \approx g_m v_{be}$ is also zero.

In reality there is a thermally generated leakage current, I_Q , which shunts I_λ . Therefore, the terminal current will be non-zero. This current, I_{CEO} , is typically on the order of 10 nA at room temperature and may in most cases be neglected.

As a three lead device, the model of Figure 3 need only have a resistance, r_b' , connected to the junction of C_{bc} and C_{be} . The other end of this resistance is the base terminal. As mentioned earlier, the three lead phototransistor is less common than the two lead version. The only advantages of having the base lead available are to stabilize the device operation for significant temperature excursions, or to use the base for unique circuit purposes.

Mention is often made of the ability to optimize a phototransistor's sensitivity by using the base. The idea is that the device can be electrically biased to a collector current at which hFE is maximum. However, the introduction of any impedance into the base results in a net decrease in photo sensitivity. This is similar to the effect noticed when I_{CEO} is measured for a transistor and found to be greater than I_{CER} . The base-emitter resistor shunts some current around the base-emitter junction, and the shunted current is never multiplied by hFE .

Now when the phototransistor is biased to peak hFE , the magnitude of base impedance is low enough to shunt an appreciable amount of photo current around the base-emitter. The result is actually a lower device sensitivity than found in the open base mode.

Spectral Response – As mentioned previously, a transistor is sensitive to light of a proper wavelength. Actually, response is found for a range of wavelengths. Figure 4 shows the normalized response for a typical phototransistor series (Motorola MRD devices) and indicates that peak response occurs at a wavelength of 0.8 μm . The warping in the response curve in the vicinity of 0.6 μm results from adjoining bands of constructive and destructive interference in the SiO_2 layer covering the transistor surface.

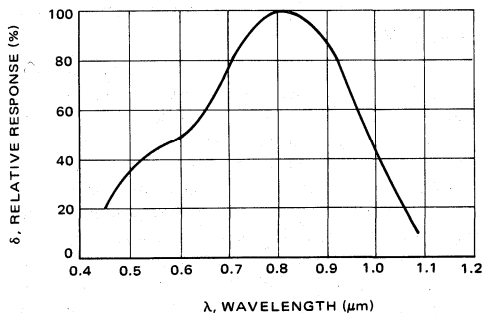

FIGURE 4 – Constant Energy Spectral Response for MRD Phototransistor Series

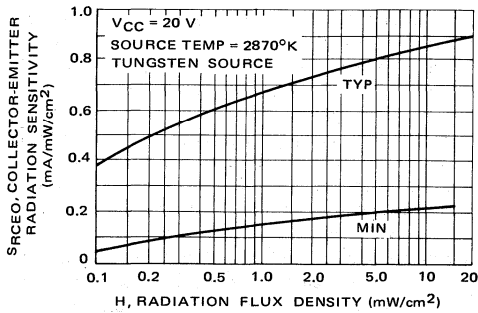

FIGURE 5 — Radiation Sensitivity for MRD901

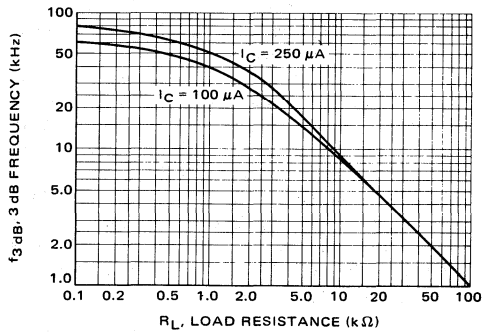

FIGURE 7 — 3 dB Frequency versus Load Resistance for MRD Phototransistor Series

Radiation Sensitivity — The absolute response of the MRD901 phototransistor to impinging radiation is shown in Figure 5. This response is standardized to a tungsten source operating at a color temperature of 2870°K. As subsequent discussion will show, the transistor sensitivity is quite dependent on the source color temperature.

Additional static characteristics are discussed in detail in AN-440, and will not be repeated here.

LOW-FREQUENCY AND STEADY-STATE DESIGN APPROACHES

For relatively simple circuit designs, the model of Figure 3 can be replaced with that of Figure 6. The justification for eliminating consideration of device capacitance is based on restricting the phototransistor's use to d.c. or low frequency applications. The actual frequency range of validity is also a function of load resistance. For example, Figure 7 shows a plot of the 3 dB response frequency as a function of load resistance.

Assume a modulated light source is to drive the phototransistor at a maximum frequency of 10 kHz. If the resultant photo current is 100 μA, Figure 7 shows a 3-dB frequency of 10 kHz at a load resistance of 8 kilohms. Therefore, in this case, the model of Figure 6 can be used with acceptable results for a load less than 8

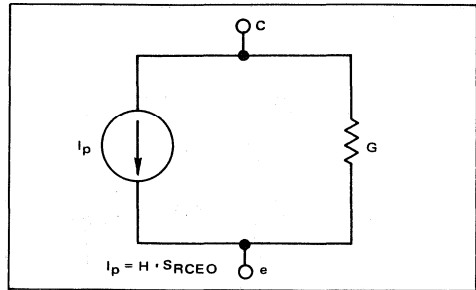

FIGURE 6 — Low-Frequency and Steady-State Model for Floating-Base Phototransistor

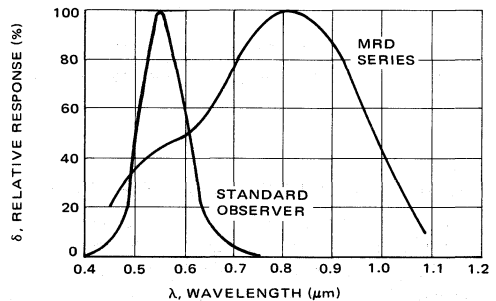

FIGURE 8 — Spectral Response for Standard Observer and MRD Series

kilohms. For larger loads, the hybrid-pi model must be used.

For the remainder of the discussion of low frequency and steady state design, it is assumed that the simplified model of Figure 6 is valid.

RADIATION AND ILLUMINATION SOURCES

The effect of a radiation source on a photo-transistor is dependent on the transistor spectral response and the spectral distribution of energy from the source. When discussing such energy, two related sets of terminology are available. The first is radiometric which is a physical system; the second is photometric which is a physiological system.

The photometric system defines energy relative to its visual effect. As an example, light from a standard 60 watt-bulb is certainly visible, and as such, has finite photometric quantity, whereas radiant energy from a 60-watt resistor is not visible and has zero photometric quantity. Both items have finite radiometric quantity.

The defining factor for the photometric system is the spectral response curve of a standard observer. This is shown in Figure 8 and is compared with the spectral response of the MRD series. The defining spectral response of the radiometric system can be imagined as unit response for all wavelengths.

A comparison of the terminology for the two systems is given in Table I.

There exists a relationship between the radiometric and photometric quantities such that at a wavelength of 0.55 μm, the wavelength of peak response for a standard observer, one watt of radiant flux is equal to 680 lumens of luminous flux. For a broadband of radiant flux, the visually effective, or photometric flux is given by:

$$F = K \int P(\lambda) \delta(\lambda) d\lambda \quad (2a)$$

where

K is the proportionality constant (of 680 lumens/watt),

P(λ) is the absolute spectral distribution of radiant flux,

δ(λ) is the relative response of the standard observer,

and

dλ is the differential wavelength,

A similar integral can be used to convert incident radiant flux density, or irradiance, to illuminance:

$$E = K \int H(\lambda) \delta(\lambda) d\lambda \quad (2b)$$

In Equation(2b) if H(λ) is given in watts/cm², E will be in lumens/cm². To obtain E in footcandles (lumens/ft²), the proportionality constant becomes

$$K = 6.3 \times 10^5 \text{ footcandles/mW/cm}^2$$

Fortunately, it is usually not necessary to perform the above integrations. The photometric effect of a radiant source can often be measured directly with a photometer.

Unfortunately, most phototransistors are specified for use with the radiometric system. Therefore, it is often necessary to convert photometric source data, such as the candle power rating of an incandescent lamp to radiometric data. This will be discussed shortly.

GEOMETRIC CONSIDERATIONS

In the design of electro-optic systems, the geometrical relationships are of prime concern. A source will effectively appear as either a point source, or an area source, depending upon the relationship between the size of the source and the distance between the source and the detector.

Point Sources – A point source is defined as one for which the source diameter is less than ten percent of the distance between the source and the detector, or,

$$\alpha < 0.1r, \quad (3)$$

where

α is the diameter of the source, and

r is the distance between the source and the detector.

Figure 9 depicts a point source radiating uniformly in every direction. If equation (3) is satisfied, the detector area, A_D, can be approximated as a section of the area of a sphere of radius r whose center is the point source.

The solid angle, ω, in steradians² subtended by the detector area is

$$\omega = \frac{A_D}{r^2} \quad (4)$$

Since a sphere has a surface area of 4πr², the total solid angle of a sphere is

$$\omega_S = \frac{4\pi r^2}{r^2} = 4\pi \text{ steradians.}$$

Table II lists the design relationships for a point source in terms of both radiometric and photometric quantities.

The above discussion assumes that the photodetector is aligned such that its surface area is tangent to the sphere with the point source at its center. It is entirely possible that the plane of the detector can be inclined from the

TABLE I – Radiometric and Photometric Terminology

Description	Radiometric	Photometric
Total Flux	Radiant Flux, P, in Watts	Luminous Flux, F, in Lumens
Emitted Flux Density at a Source Surface	Radiant Emittance, W, in Watts/cm ²	Luminous Emittance, L, in Lumens/ft ² (foot-lamberts), or lumens/cm ² (Lamberts)
Source Intensity (Point Source)	Radiant Intensity, I _r , in Watts/Steradian	Luminous Intensity, I _L , in Lumens/Steradian (Candela)
Source Intensity (Area Source)	Radiance, B _r , in (Watts/Steradian) /cm ²	Luminance, B _L , in (Lumens/Steradian) /ft ² (footlambert)
Flux Density Incident on a Receiver Surface	Irradiance, H, in Watts/cm ²	Illuminance, E, in Lumens/ft ² (footcandle)

TABLE II – Point Source Relationships

Description	Radiometric	Photometric
Point Source Intensity	I _r , Watts/Steradian	I _L , Lumens/Steradian
Incident Flux Density	H (Irradiance) = $\frac{I_r}{r^2}$, watts/distance ²	E (Illuminance) = $\frac{I_L}{r^2}$, lumens/distance ²
Total Flux Output of Point Source	P = 4πI _r , Watts	F = 4πI _L , Lumens

TABLE III – Design Relationships for an Area Source

Description	Radiometric	Photometric
Source Intensity	B _r , Watts/cm ² /steradian	B _L , Lumens/cm ² /steradian
Emitted Flux Density	W = πB _r , Watts/cm ²	L = πB _L , Lumens/cm ²
Incident Flux Density	H = $\frac{B_r A_s}{r^2 + (y/2)^2}$, Watts/cm ²	E = $\frac{B_L A_S}{r^2 + (y/2)^2}$, Lumens/cm ²

² Steradian: The solid equivalent of a radian.



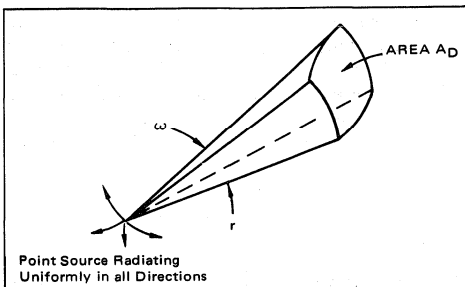

FIGURE 9 – Point Source Geometry

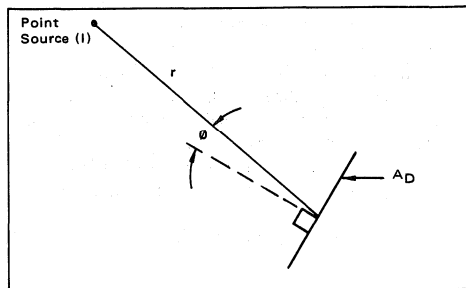

FIGURE 10 – Detector Not Normal to Source Direction

tangent plane. Under this condition, as depicted in Figure 10, the incident flux density is proportional to the cosine of the inclination angle, ϕ . Therefore,

$$H = \frac{I_r}{r^2} \cos \phi, \text{ and} \quad (5a)$$

$$E = \frac{I_L}{r^2} \cos \phi. \quad (5b)$$

AREA SOURCES

When the source has a diameter greater than 10 percent of the separation distance,

$$\alpha \geq 0.1r, \quad (6)$$

it is considered to be an area source. This situation is shown in Figure 11. Table III lists the design relationships for an area source.

A special case that deserves some consideration occurs when

$$\frac{\alpha}{2} \gg r, \quad (7)$$

that is, when the detector is quite close to the source. Under this condition,

$$H = \frac{B_r A_s}{r^2 + \left(\frac{\alpha}{2}\right)^2} \approx \frac{B_r A_s}{\left(\frac{\alpha}{2}\right)^2}, \quad (8)$$

but, the area of the source,

$$A_s = \pi \left(\frac{\alpha}{2}\right)^2, \quad (9)$$

Therefore,

$$H \approx B_r \pi = W, \quad (10)$$

That is, the emitted and incident flux densities are equal. Now, if the area of the detector is the same as the area of the source, and equation (7) is satisfied, the total incident energy is approximately the same as the total

radiated energy, that is, unity coupling exists between source and detector.

LENS SYSTEMS

A lens can be used with a photodetector to effectively increase the irradiance on the detector. As shown in Figure 12a, the irradiance on a target surface for a point source of intensity, I , is

$$H = I/d^2, \quad (11)$$

where d is the separation distance.

In Figure 12b a lens has been placed between the source and the detector. It is assumed that the distance d' from the source to the lens is approximately equal to d :

$$d' \approx d, \quad (12)$$

and the solid angle subtended at the source is sufficiently small to consider the rays striking the lens to be parallel.

If the photodetector is circular in area, and the distance from the lens to the detector is such that the image of the source exactly fills the detector surface area, the radiant flux on the detector (assuming no lens loss) is

$$P_D = P_L = H' \pi r_L^2, \quad (13)$$

where

P_D is the radiant flux incident on the detector,

P_L is the radiant flux incident on the lens,

H' is the flux density on the lens, and

r_L is the lens radius.

Using equation (12),

$$H' = I/d^2 = H. \quad (14)$$

The flux density on the detector is

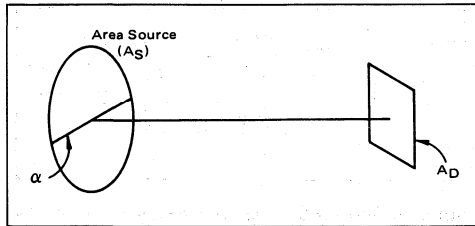

FIGURE 11 – Area Source Geometry

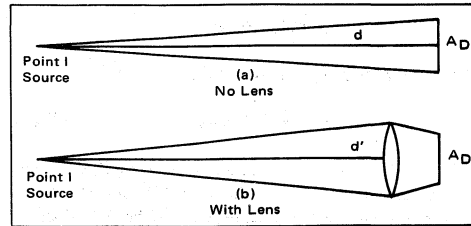

Figure 12 – Use of a Lens to Increase Irradiance on a Detector

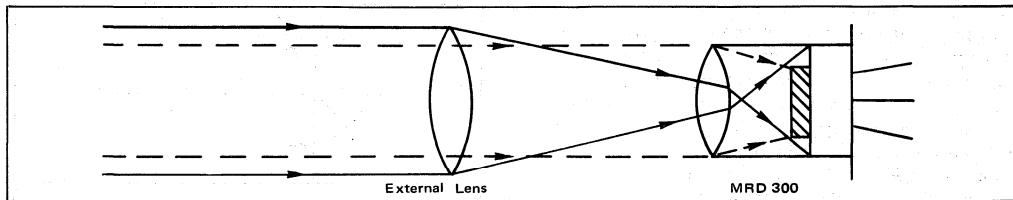

FIGURE 13 – Possible Misalignment Due to Arbitrary Use of External Lens Dotted Rays Indicate Performance Without External Lens

$$H_D = P_D/A_D, \quad (15)$$

where A_D is the detector area, given by

$$A_D = \pi r_d^2. \quad (16)$$

Using (13), (14), and (16) in (15) gives

$$H_D = \frac{1}{d^2} \left(\frac{r_L}{r_d} \right)^2 \quad (17)$$

Now dividing (17) by (11) gives the ratio of irradiance on the detector with a lens to the irradiance without a lens.

$$\frac{H_D}{H} = \frac{1}{d^2} \left(\frac{r_L}{r_d} \right)^2 = \left(\frac{r_L}{r_d} \right)^2 \quad (18)$$

As (18) shows, if the lens radius is greater than the detector radius, the lens provides an increase in incident irradiance on the detector. To account for losses in the lens, the ratio is reduced by about ten percent.

$$R = 0.9 \left(\frac{r_L}{r_d} \right)^2 \quad (19)$$

where R is the gain of the lens system.

It should be pointed out that arbitrary placement of a lens may be more harmful than helpful. That is, a lens system must be carefully planned to be effective.

For example, the MRD300 phototransistor contains a lens which is effective when the input is in the form of parallel rays (as approximated by a uniformly radiating point source). Now, if a lens is introduced in front of the MRD300 as shown in Figure 13, it will provide a non-

parallel ray input to the transistor lens. Thus the net optical circuit will be misaligned. The net irradiance on the phototransistor chip may in fact be less than without the external lens. The circuit of Figure 14 does show an effective system. Lens 1 converges the energy incident on its surface to lens 2 which reconverts this energy into parallel rays. The energy entering the phototransistor lens as parallel rays is the same (neglecting losses) as that entering lens 1. Another way of looking at this is to imagine that the phototransistor surface has been increased to a value equal to the surface area of lens 1.

FIBER OPTICS

Another technique for maximizing the coupling between source and detector is to use a fiber bundle to link the phototransistor to the light source. The operation of fiber optics is based on the principle of total internal reflection.

Figure 15 shows an interface between two materials of different indices of refraction. Assume that the index of refraction, n , of the lower material is greater than that, n' , of the upper material. Point P represents a point source of light radiating uniformly in all directions. Some rays from P will be directed at the material interface.

At the interface, Snell's law requires:

$$n \sin \theta = n' \sin \theta', \quad (20)$$

where

θ is the angle between a ray in the lower material and the normal to the interface,

and

θ' is the angle between a refracted ray and the normal.

Rearranging (20),

$$\sin \theta' = \frac{n}{n'} \sin \theta. \quad (21)$$

By assumption, n/n' is greater than one, so that

$$\sin \theta' > \sin \theta. \quad (22)$$

However, since the maximum value of $\sin \theta'$ is one and occurs when θ' is 90° , θ' will reach 90° before θ does. That is, for some value of θ , defined as the critical angle, θ_C , rays from P do not cross the interface. When $\theta > \theta_C$, the rays are reflected entirely back into the lower material, or total internal reflection occurs.

Figure 16 shows the application of this principle to fiber optics. A glass fiber of refractive index n is clad with a layer of glass of lower refractive index, n' . A ray of light entering the end of the cable will be refracted as shown. If, after refraction, it approaches the glass interface at an angle greater than θ_C , it will be reflected within the fiber. Since the angle of reflection must equal the angle of incidence, the ray will bounce down the fiber and emerge, refracted, at the exit end.

The numerical aperture, NA, of a fiber is defined as the sin of the half angle of acceptance. Application of Snell's law at the interface for θ_C , and again at the fiber end will give

$$NA \equiv \sin \phi = \sqrt{n^2 - n'^2}. \quad (23)$$

For total internal reflection to occur, a light ray must enter the fiber within the half angle ϕ .

Once a light ray is within the fiber, it will suffer some attenuation. For glass fibers, an absorption rate of from five to ten per cent per foot is typical. There is also an entrance and exit loss at the ends of the fiber which typically result in about a thirty per cent loss.

As an example, an illuminance E at the source end of a three-foot fiber bundle would appear at the detector as

$$E_D = 0.7 E e^{-\alpha L} = 0.7 E e^{-(0.1)(3)} = 0.51 E, \quad (24)$$

where E is the illuminance at the source end,

E_D is the illuminance at the detector end,

α is the absorption rate, and

L is the length.

This assumes an absorption loss of ten percent per foot.

TUNGSTEN LAMPS

Tungsten lamps are often used as radiation sources for photodetectors. The radiant energy of these lamps is distributed over a broad band of wavelengths. Since the eye and the phototransistor exhibit different wavelength-dependent response characteristics, the effect of a tungsten lamp will be different for both. The spectral output of a tungsten lamp is very much a function of color temperature.

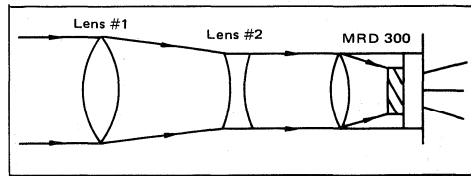

FIGURE 14 – Effective Use of External Optics with the MRD 300

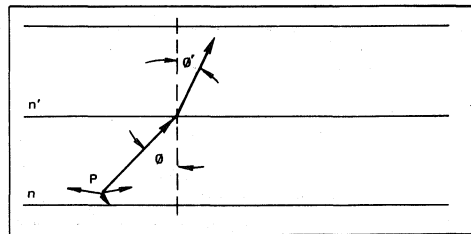

FIGURE 15 – Ray Refraction at an Interface

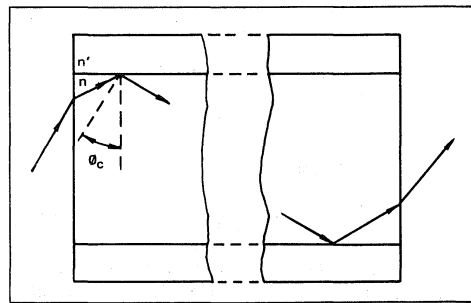

FIGURE 16 – Refraction in an Optical Fiber

Color temperature of a lamp is the temperature required by an ideal blackbody radiator to produce the same visual effect as the lamp. At low color temperatures, a tungsten lamp emits very little visible radiation. However, as color temperature is increased, the response shifts toward the visible spectrum. Figure 17 shows the spectral distribution of tungsten lamps as a function of color temperature. The lamps are operated at constant wattage and the response is normalized to the response at 2800°K . For comparison, the spectral response for both the standard observer and the MRD phototransistor series are also plotted. Graphical integration of the product of the standard observer response and the pertinent source distribution from Figure 17 will provide a solution to equations (2a) and (2b).

Effective Irradiance – Although the sensitivity of a photodetector to an illuminant source is frequently provided, the sensitivity to an irradiant source is more common. Thus, it is advisable to carry out design work in

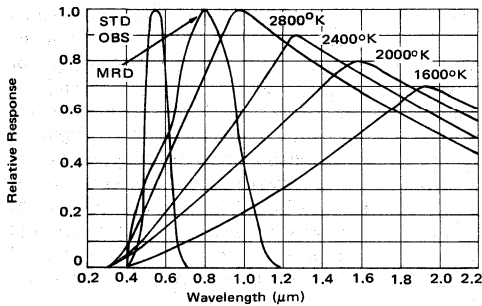

FIGURE 17 – Radiant Spectral Distribution of Tungsten Lamp

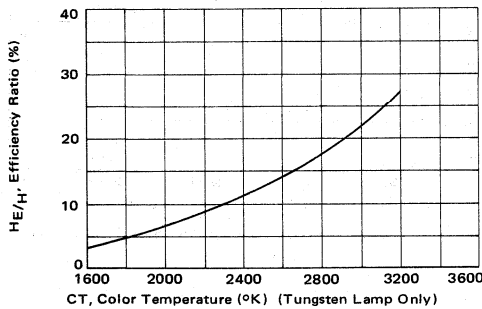

FIGURE 18 – MRD Irradiance Ratio versus Color Temperature

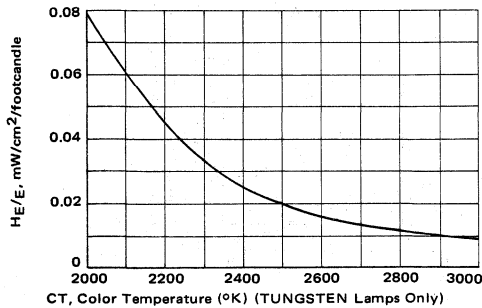

FIGURE 19 – MRD Irradiance/Illuminance Ratio versus Color Temperature

terms of irradiance. However, since the spectral response of a source and a detector are, in general, not the same, a response integration must still be performed. The integral is similar to that for photometric evaluation.

$$P_E = \int P(\lambda) Y(\lambda) d\lambda \quad (25)$$

where

P_E is the effective radiant flux on the detector, $P(\lambda)$ is the spectral distribution of source flux

and

$Y(\lambda)$ is the spectral response of the detector.

Again, such an integration is best evaluated graphically. In terms of flux density, the integral is

$$H_E = \int H(\lambda) Y(\lambda) d\lambda \quad (26)$$

where H_E is the effective flux density (irradiance) on the detector

and $H(\lambda)$ is the absolute flux density distribution of the source on the detector.

Graphical integration of equations (2b) and (26) has been performed for the MRD series of phototransistors for several values of lamp color temperature. The results are given in Figures 18 and 19 in terms of ratios. Figure 18 provides the irradiance ratio, H_E/H_r versus color temperature. As the curve shows, a tungsten lamp operating at 2600°K is about 14% effective on the MRD series devices. That is, if the broadband irradiance of such a lamp is measured at the detector and found to be 20 mW/cm^2 , the transistor will effectively see

$$H_E = 0.14 (20) = 2.8 \text{ mW/cm}^2 \quad (27)$$

The specifications for the MRD phototransistor series include the correction for effective irradiance. For example, the MRD901 is rated for a typical sensitivity of 0.8 $mA/mW/cm^2$. This specification is made with a tungsten source operating at 2870°K and providing an irradiance at the transistor of 5.0 mW/cm^2 . Note that this will result in a current flow of 4.0 mA .

However, from Figure 18, the effective irradiance is

$$H_E = (5.0)(.185) = 0.925 \text{ mW/cm}^2 \quad (28)$$

By using this value of H_E and the typical sensitivity rating it can be shown that the device sensitivity to a monochromatic irradiance at the MRD901 peak response of 0.8 μm is

$$S = \frac{I_C}{H_E} = \frac{4.0 \text{ mA}}{0.925 \text{ mW/cm}^2} = 4.33 \text{ mA/mW/cm}^2 \quad (29)$$

Now, as shown previously, an irradiance of 20 mW/cm^2 at a color temperature of 2600°K looks like monochromatic irradiance at 0.8 μm of 2.8 mW/cm^2 (Equation 27). Therefore, the resultant current flow is

$$I = S H_E (4.33)(2.8) = 12.2 \text{ mA} \quad (30)$$

An alternate approach is provided by Figure 20. In this figure, the relative response as a function of color temperature has been plotted. As the curve shows, the response is down to 83% at a color temperature of 2600°K. The specified typical response for the MRD450 at 20 mW/cm^2 for a 2870°K tungsten source is 0.9 $mA/mW/cm^2$. The current flow at 2600°K and 20 mW/cm^2 is therefore

$$I = (0.83)(0.9)(20) = 14.9 \text{ mA} \quad (31)$$

This value agrees reasonably well with the result obtained in Equation 30. Similarly, Figure 19 will show that a current flow of 6.67 mA will result from an illuminance of 125 foot candles at a color temperature of 2600°K.

Determination of Color Temperature – It is very likely that a circuit designer will not have the capability to measure color temperature. However, with a voltage measuring capability, a reasonable approximation of color temperature may be obtained. Figure 21 shows the classical variation of lamp current, candlepower and lifetime for a tungsten lamp as a function of applied voltage. Figure 22 shows the variation of color temperature as a function of the ratio

$$\rho = \frac{\text{MSCP}}{\text{WATT}} \quad (32)$$

where

MSCP is the mean spherical candlepower at the lamp operating point and WATT is the lamp IV product at the operating point.

As an example, suppose a type 47 indicator lamp is used as a source for a phototransistor. To extend the lifetime, the lamp is operated at 80% of rated voltage.

Lamp	Rated Volts	Rated Current	MSCP
47	6.3V	150 mA	0.52 approx

Geometric Considerations – The candlepower ratings on most lamps are obtained from measuring the total lamp output in an integrating sphere and dividing by the unit solid angle. Thus the rating is an average, or mean-spherical-candlepower. However, a tungsten lamp cannot radiate uniformly in all directions, therefore, the candlepower varies with the lamp orientation. Figure 23 shows the radiation pattern for a typical frosted tungsten lamp. As shown, the maximum radiation occurs in the horizontal direction for a base-down or base-up lamp. The circular curve simulates the output of a uniform radiator, and contains the same area as the lamp polar plot. It indicates that the lamp horizontal output is about 1.33

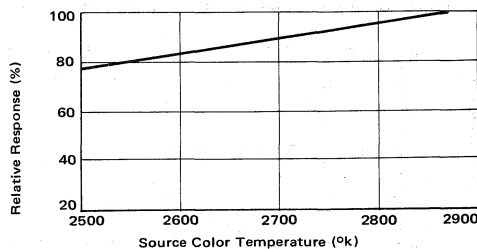

FIGURE 20 – Relative Response of MRD Series versus Color Temperature

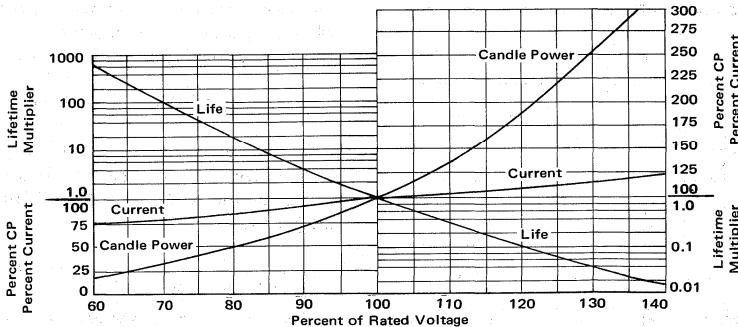

FIGURE 21 – Tungsten Lamp Parameter Variations versus Variations about Rated Voltage

From Figure 21 for 80% rated voltage,
 (Rated Current) (Percent current) = (.15)(0.86) = 0.129 ampere
 (Rated CP) (Percent CP) = (0.5)(0.52) = 0.26 CP
 (Rated Voltage) (Percent Voltage) = (6.3)(0.8) = 5.05 V

$$\text{WATTS} = (5.05)(0.129) = 0.65$$

$$\rho = \frac{0.26}{0.65} = 0.4,$$

From Figure 22, for $\rho = 0.4$,

$$\text{CT} = 2300^\circ\text{K},$$

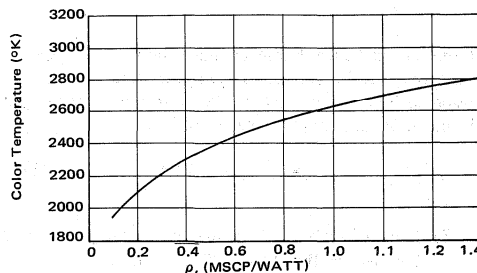

FIGURE 22 – Color Temperature versus Candle Power/Power Ratio

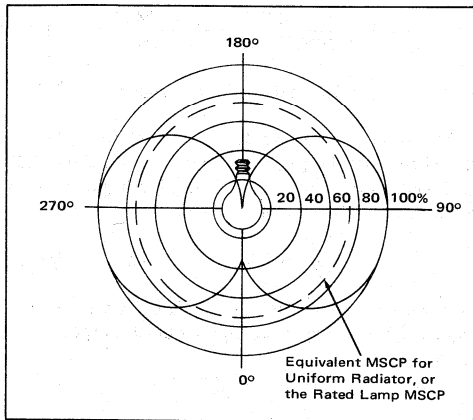

FIGURE 23 – Typical Radiation Pattern for a Frosted Incandescent Lamp

times the rated MSCP, while the vertical output, opposite the base, is 0.48 times the rated MSCP.

The actual polar variation for a lamp will depend on a variety of physical features such as filament shape, size and orientation and the solid angle intercepted by the base with respect to the center of the filament.

If the lamp output is given in horizontal candlepower (HCP), a fairly accurate calculation can be made with regard to illuminance on a receiver.

A third-form of rating is beam candlepower, which is provided for lamps with reflectors.

In all three cases the rating is given in lumens/steradian or candlepower.

SOLID STATE SOURCES

In contrast with the broadband source of radiation of the tungsten lamp, solid state sources provide relatively narrow band energy. The gallium arsenide (GaAs) light-emitting-diode (LED) has spectral characteristics which make it a favorable mate for use with silicon photo-detectors. LED's are available for several wavelengths, as

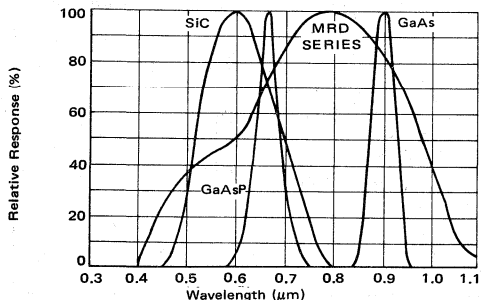

FIGURE 24 – Spectral Characteristics for Several LED's Compared with MRD Series

shown in Figure 24, but as the figure shows, the GaAs diode and the MRD phototransistor series are particularly compatible. Application of Equation (26) to the GaAs response and the MRD series response indicates that the efficiency ratio, H_E/H , is approximately 0.9 or 90%. That is, an irradiance of 4.0 mW/cm^2 from an LED will appear to the phototransistor as 3.6 mW/cm^2 . This means that a typical GaAs LED is about 3.5 times as effective as a tungsten lamp at 2870°K . Therefore, the typical sensitivity for the MRD450 when used with a GaAs LED is approximately

$$S = (0.8)(3.5) = 2.8 \text{ mA/mW/cm}^2 \quad (33)$$

An additional factor to be considered in using LED's is the polar response. The presence of a lens in the diode package will confine the solid angle of radiation. If the solid angle is θ , the resultant irradiance on a target located at a distance d is

$$H = \frac{4P}{\pi\theta^2 d^2} \text{ watts/cm}^2, \quad (34)$$

where

- P is the total output power of the LED in watts
- θ is the beam angle
- d is the distance between the LED and the detector in cm.

LOW FREQUENCY AND STEADY STATE APPLICATIONS

Light Operated Relay – Figure 25 shows a circuit in which presence of light causes a relay to operate. The relay used in this circuit draws about 5 mA when Q2 is in saturation. Since $h_{FE}(\text{min})$ for the MPS3394 is 55 at a collector current of 2mA, a base current of 0.5 mA is sufficient to ensure saturation. Phototransistor Q1 provides the necessary base drive. If the MRD300 is used, the minimum illumination sensitivity is $4 \mu\text{A/footcandle}$, therefore,

$$E = \frac{I_C}{S_{ICEO}} = \frac{0.5 \text{ mA}}{4 \times 10^{-3} \text{ mA/footcandle}} \quad (35)$$

$$E = 125 \text{ footcandles}$$

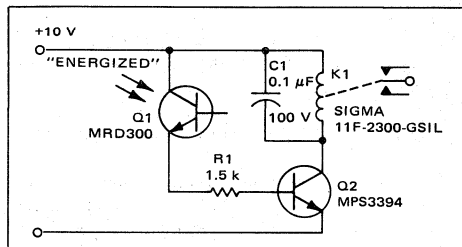

FIGURE 25 – Light-Operated Relay

This light level can be supplied by a flashlight or other equivalent light source.

The equivalent irradiance is obviously that value of irradiance which will cause the same current flow. Assume the light source is a flashlight using a PR2 lamp. The ratings for this lamp are

Lamp	Rated Volts	Rated Current	MSCP
PR2	2.38	0.50 A	0.80

If the flashlight has new batteries the lamp voltage is

$$V_L = 2(1.55) = 3.1 \text{ volts} \quad (36)$$

This means that the lamp is operated at 130 per cent of rated voltage. From Figure 21 for 130% rated voltage, (Rated Current) (Percent Current) = (0.5)(1.15) = 0.575 ampere
(Rated CP) (Percent CP) = (0.80)(2.5) = 2 CP
(Rated Voltage) (Percent Voltage) = (2.38)(1.3) = 3.1 volts.

Therefore, the MSCP/watt rating is 1.12. From Figure 22, the color temperature is 2720°K.

Now, from Figure 20, the response at a color temperature of 2720°K is down to 90% of its reference value. At the reference temperature, the minimum SRCEO for the MRD300 is 0.8 mA/mW/cm², so at 2720°K it is

$$SRCEO (\text{MIN}) = (0.9)(0.8) = 0.72 \text{ mA/mW/cm}^2 \quad (37)$$

and

$$H_E = \frac{I_C}{SRCEO} = \frac{0.5}{0.72} = 0.65 \text{ mW/cm}^2 \quad (38)$$

However, sensitivity is a function of irradiance, and at 0.695 mW/cm² it has a minimum value (at 2720°K) of about 0.45 mA/mW/cm², therefore

$$H_E = \frac{0.5}{0.45} = 1.11 \text{ mW/cm}^2 \quad (39)$$

Again, we note that at an irradiance of 1.11 mW/cm², the minimum SRCEO is about 0.54 mA/mW/cm². Several applications of the above process eventually result in a convergent answer of

$$H_E \approx 1.0 \text{ mW/cm}^2 \quad (40)$$

Now, from the MRD901 data sheet, SRCEO (min) at an irradiance of 1.0 mW/cm² and color temperature of 2720°K is

$$SRCEO = (0.15)(0.9) = 0.135 \text{ mA/mW/cm}^2 \quad (41)$$

At 1.0 mW/cm², we can expect a minimum I_C of 0.135 mA. This is below the design requirement of 0.5 mA. By looking at the product of SRCEO (min) and H on the data sheet curve, the minimum H for using the MRD450 can now be calculated.

$$\frac{H}{H_E} = \frac{3.0}{1.0} = \frac{I (\text{MRD901})}{I (\text{MRD300})} = \frac{I (\text{MRD901})}{125} \quad (42)$$

or

$$I (\text{MRD450}) = 375 \text{ footcandles} \quad (43)$$

This value is pretty high for a two D-cell flashlight, but the circuit should perform properly since about 200 footcandles can be expected from a flashlight, giving a resultant current flow of approximately

$$I = \frac{220}{275} (0.5 \text{ mA}) = 0.293 \text{ mA} \quad (44)$$

This will be the base current of Q2, and since the relay requires 5 mA, the minimum h_{FE} required for Q2 is

$$h_{FE} (Q2) = \frac{5}{0.293} = 17. \quad (45)$$

This is well below the h_{FE} (min) specification for the MPS3394 (55) so proper circuit performance can be expected.

A variation of the above circuit is shown in Figure 26. In this circuit, the presence of light deenergizes the relay. The same light levels are applicable. The two relay circuits can be used for a variety of applications such as automatic door activators, object or process counters, and intrusion alarms. Figure 27, for example, shows the circuit of Figure 26 used to activate an SCR in an alarm system. The presence of light keeps the relay deenergized, thus denying trigger current to the SCR gate. When the light is interrupted, the relay energizes, providing the SCR with trigger current. The SCR latches ON, so only a momentary interruption of light is sufficient to cause the alarm to ring continuously. S1 is a momentary contact switch for resetting the system.

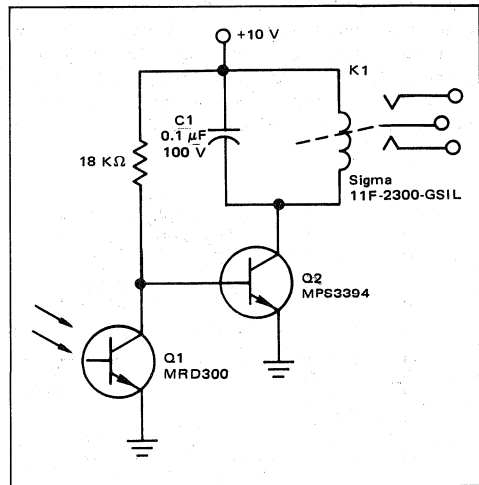

FIGURE 26 — Light De-energized Relay

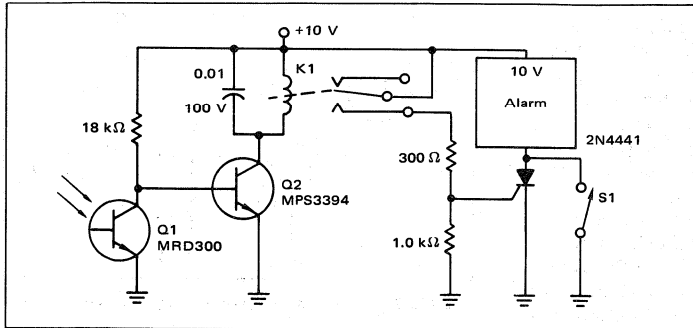

FIGURE 27 – Light-Relay Operated SCR Alarm Circuit

If the SCR has a sensitive gate, the relay can be eliminated as shown in Figure 28. The phototransistor holds the gate low as long as light is present, but pulls the gate up to triggering level when the light is interrupted. Again, a reset switch appears across the SCR.

Voltage Regulator – The light output of an incandescent lamp is very dependent on the RMS voltage applied to it. Since the phototransistor is sensitive to light changes, it can be used to monitor the light output of a lamp, and in a closed-loop system to control the lamp voltage. Such a regulator is particularly useful in a projection system where it is desired to maintain a constant brightness level despite line voltage variations.

Figure 29 shows a voltage regulator for a projection lamp. The RMS voltage on the lamp is set by the firing angle of the SCR. This firing angle in turn is set by the unijunction timing circuit. Transistors Q1 and Q2 form a constant-current source for charging timing capacitor C.

The magnitude of the charging current, the capacitance, C, and the position of R6 set the firing time of the UJT oscillator which in turn sets the firing angle of the SCR. Regulation is accomplished by phototransistor Q3. The brightness of the lamp sets the current level in Q3, which diverts current from the timing capacitor. Potentiometer R6 is set for the desired brightness level.

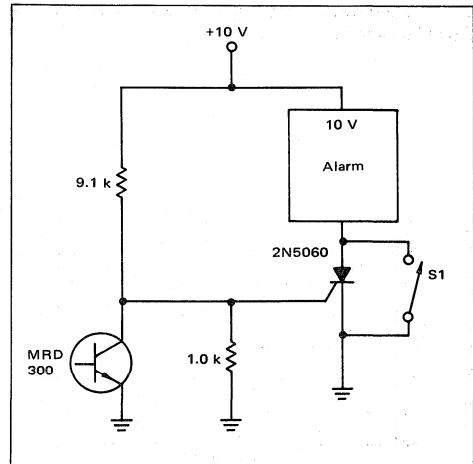

FIGURE 28 – Light Operated SCR Alarm Using Sensitive-Gate SCR

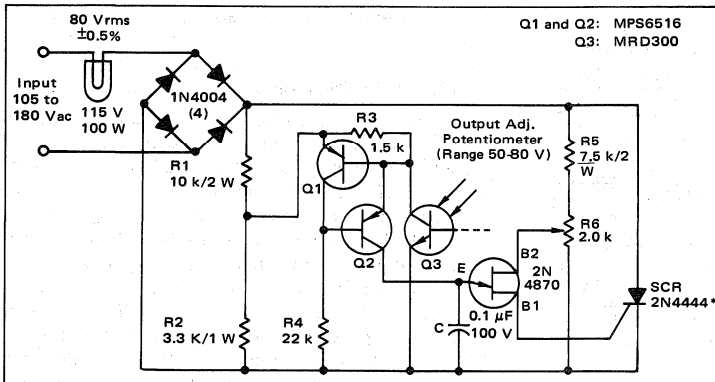

FIGURE 29 – Circuit Diagram of Voltage Regulator for Projection Lamp.

*2N4444 to be used with a heat sink.

If the line voltage rises, the lamp tends to become brighter, causing an increase in the current of Q3. This causes the unijunction to fire later in the cycle, thus reducing the conduction time of the SCR. Since the lamp RMS voltage depends on the conduction angle of the SCR, the increase in line voltage is compensated for by a decrease in conduction angle, maintaining a constant lamp voltage.

Because the projection lamp is so bright, it will saturate the phototransistor if it is directly coupled to it. Either of two coupling techniques are satisfactory. The first is to attenuate the light to the phototransistor with a translucent material with a small iris. The degree of attenuation or translucency must be experimentally determined for the particular projection lamp used.

The second coupling technique is to couple the lamp and phototransistor by a reflected path. The type of reflective surface and path length will again depend on the particular lamp being used.

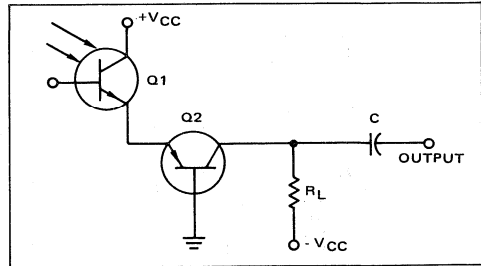

FIGURE 32 – Improved Speed Configuration for Phototransistor

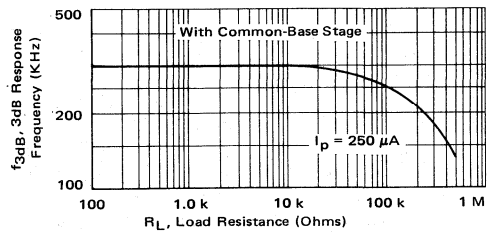

FIGURE 33 – 3dB Frequency Response for Speed-up Circuit

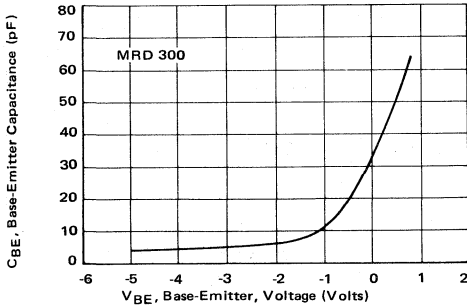

FIGURE 30 – MRD300 Base-Emitter Junction Capacitance versus Voltage

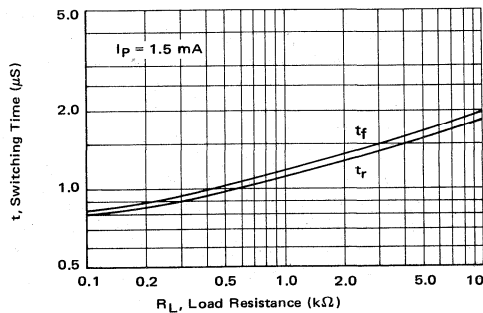

FIGURE 34 – Switching Times with Speed-up Circuit

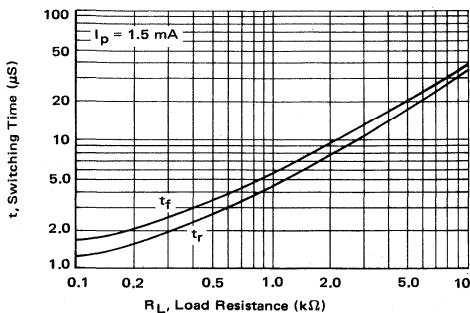

FIGURE 31 – MRD300 Switching Times versus Load Resistance

HIGH FREQUENCY DESIGN APPROACHES

It was shown in Figure 7 that the frequency response of the MRD phototransistor series is quite dependent on the load. Depending on the load value and the frequency of operation, the device can be modeled simply as in Figure 6, or else in the modified hybrid-pi form of Figure 3.

While the hybrid-pi model may be useful for detailed analytical work, it does not offer much for the case of simplified design. It is much easier to consider the transistor simply as a current source with a first-order transient response. With the addition of switching characteristics to the device information already available, most design problems can be solved with a minimum of effort.

Switching Characteristics — When the phototransistor changes state from OFF to ON, a significant time delay is associated with the τ_{be} C_{be} time constant. As shown in Figure 30, the capacitance of the emitter-base junction is appreciable. Since the device photocurrent is $g_m v_{be}$ (from Figure 3), the load current can change state only as fast as v_{be} can change. Also, v_{be} can change only as fast as C_{be} can charge and discharge through the load resistance. Figure 31 shows the variations in rise and fall time with load resistance. This measurement was made using a GaAs light emitting diode for the light source. The LED output power and the separation distance between the LED and the phototransistor were adjusted for an ON phototransistor current of 1.5 mA. The rise time was also measured for a short-circuited load and found to be about 700 ns.

The major difficulty encountered in high-frequency applications is the load-dependent frequency response. Since the phototransistor is a current source, it is desirable to use a large load resistance to develop maximum output voltage. However, large load resistances limit the useful frequency range. This seems to present the designer with a tradeoff between voltage and speed. However, there is a technique available to eliminate the need for such a tradeoff.

Figure 32 shows a circuit designed to optimize both speed and output voltage. The common-base stage Q2 offers a low-impedance load to the phototransistor, thus maximizing response speed. Since Q2 has near-unity current gain, the load current in R_L is approximately equal to the phototransistor current. Thus the impedance transformation provided by Q2 results in a relatively load-independent frequency response.

The effect of Q2 is shown in Figures 33 and 34. In Figure 33, the 3-dB frequency response as a function of load is shown. Comparing this with Figure 7, the effect of Q2 is quite evident. Comparison of Figures 31 and 34 also demonstrates the effect of Q2.

Remote Strobe Flash Slave Adapter — At times when using an electronic strobe flash, it is desirable to use a remote, or "slave" flash synchronized with the master. The circuit in Figure 35 provides the drive needed to trigger a slave unit, and eliminates the necessity for

synchronizing wires between the two flash units.

The MRD300 phototransistor used in this circuit is cut off in a VCEr mode due to the relatively low dc resistance of rf choke L1 even under high ambient light conditions. When a fast-rising pulse of light strikes the base region of this device, however, L1 acts as a very high impedance to the ramp and the transistor is biased into conduction by the incoming pulse of light.

When the MRD300 conducts, a signal is applied to the gate of SCR Q2. This triggers Q2, which acts as a solid-state relay and turns on the attached strobe flash unit.

In tests this unit was unaffected by ambient light conditions. It fired up to approximately 20 feet from strobe-light flashes using only the lens of the MRD300 for light pickup.

CONCLUSION

The phototransistor provides the circuit or system designer with a unique component for use in dc and linear or digital time-varying applications. Use of a phototransistor yields extremely high electrical and mechanical isolation. The proper design of an electro-optical system requires a knowledge of both the radiation source characteristics and the phototransistor characteristics. This knowledge, coupled with an adequately defined distance and geometric relationship, enables the designer to properly predict the performance of his designs.

REFERENCES

1. Motorola Application Note AN-440, *Theory and Characteristics of Phototransistors*.
2. Francis W. Sears, *Optics*, Addison-Wesley Publishing Company, Inc., 1948.
3. *IES Lighting Handbook*, 3rd Edition, Illuminating Engineering Society, 1959.

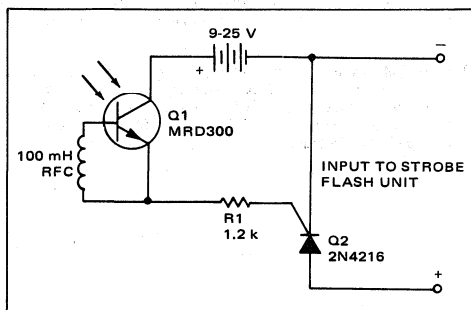

FIGURE 35 — Strobe Flash Slave Adapter

How to Use Photosensors and Light Sources

Prepared by: John Bliss
 Discrete Applications Engineering

ABSTRACT

One way to build a light-sensing system is to fish a few components out of a junk box, throw them together and "fire up" the system. The minute it "works," the "design" is frozen and the prototype is ready.

While minimizing engineering, this approach is sure to maximize potential problems. You can expect field failures and the general tendency of the system to fail whenever the environment deviates from the laboratory conditions that existed during the design phase.

A reliable light-sensing system can be built without much more effort than the haphazard junk-box method. But it calls for step-by-step design. Let's examine the designs for two such systems, one for sensing incandescent light and the other for sensing light from a LED.

Sense Incandescent Light Reliability

The trouble with most designs is that data sheets for phototransistors and photodiodes usually give photocurrent or sensitivity at some irradiance level from a source operating at a particular color temperature. This information is extremely meaningful if a designer uses a tungsten source at the specified color temperature and irradiance level. However, what if the source conditions are different? Or, for that matter, how does one determine source conditions?

With an optical pyrometer and a thermopile at hand, the designer can quickly determine the source conditions. But these instruments are generally not available in most laboratories. Thus most designers are faced with these problems:

- What are the source conditions?
- What are the effects of a nonstandard source on the light sensor?

It turns out that answers to both of these questions can be obtained with sufficient accuracy.

Suppose a type 47 lamp is to be used as a light source with an MRD300 silicon phototransistor as a product counter on an assembly line. The lamp is to be operated at rated voltage, 6.3 V at 0.15 A, so its optical output is 0.52 mean spherical candlepower (mscp). This yields the following mean spherical candlepower per watt:

$$p = 0.52 / [(6.3) (0.15)] = 0.55 \text{ mscp/W.} \quad (1)$$

From Fig. 1a, a plot of color temperature versus mscp/W for small incandescent sources, we see that the color temperature corresponding to this light output is 2400 K. This is several hundred degrees below the value at which the sensitivity of the MRD300 is specified. From Fig. 1b, a plot of relative response of MRD phototransistors versus color temperature, we note that the sensitivity is 68% of the value at 2870 K.

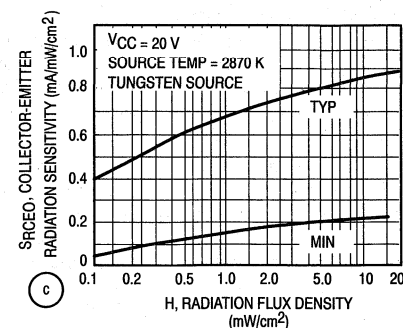
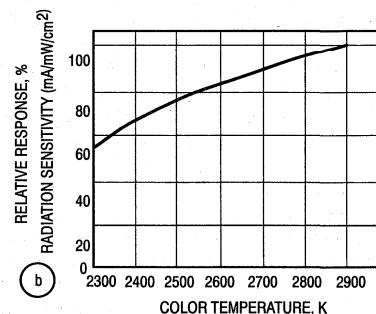
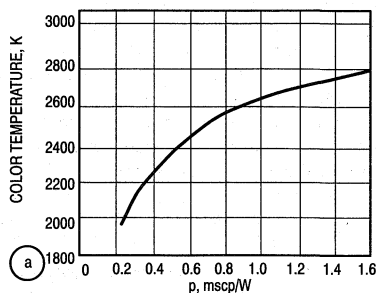

1. To predict light-sensing system performance, an incandescent source description is obtained from curve "a". Once this is done, the phototransistor relative response is obtained from "b". After calculating the radiation flux intensity, H, on the basis of data from "a" and "b", you can read the actual phototransistor radiation sensitivity from "c".

Next, the irradiance level must be determined. While the efficiency of incandescent lamps in terms of visible light is quite low — 5 to 20% — the efficiency in terms of total radiated energy is high — about 90%. Since an MRD300 detects a large amount of this energy, the total radiated power for the 47 lamp is

$$P_T = (0.9) (6.3) (0.15) = 850 \text{ mW.} \quad (2)$$

If the lamp is assumed to be a uniform point source, the source intensity is

$$I = P_T/4\pi = 67.7 \text{ mW/steradian.} \quad (3)$$

If we assume that the distance between the lamp and transistor is 20 cm, the incident irradiance is

$$H = I/d^2 = 67.7/(20)^2 = 0.17 \text{ mW/cm}^2. \quad (4)$$

The radiation sensitivity of the MRD300 as a function of irradiance (or incident flux density) for a tungsten source at 2870 K is shown in Figure 1c. Since our source color temperature is 2400 K — and thus the transistor sensitivity, from Fig. 1b, is reduced to 68% — the actual incident irradiance, H' , becomes

$$H' = (0.68)H = (0.68) (0.17) = 0.115 \text{ mW/cm}^2, \quad (5)$$

so that, directly from Figure 1c, the effective minimum radiation sensitivity is 0.06 mA/mW/cm².

Thus the expected photocurrent is given by

$$I_C = (0.115) (0.06) = 6.9 \text{ } \mu\text{A.} \quad (6)$$

If the calculated photocurrent is too low for reliable circuit performance, and if the lamp voltage and the source-to-transistor distance are fixed, a pair of lenses can be added to increase the effective irradiance (Figure 2). Here lens 1 collects the lamp light output, and lens 2 converts the light beam to parallel rays since the built-in lens of the MRD300 works best on a beam of light comprised of parallel rays.

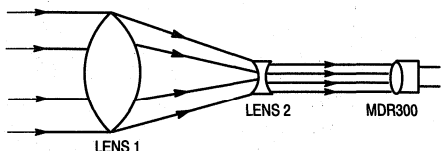

2. Photocurrent can be increased by collecting more light from the source. The radius of lens 2 is equal to the radius of the lens built into the phototransistor.

The light flux density at lens 2 is a function of the total light collected by lens 1 and the area of lens 2 — that is, if H_1 is the irradiance at lens 1 (area = πr_1^2), then

$$P = H_1 \pi r_1^2, \quad (7)$$

and the irradiance at lens 2, H_2 , becomes

$$H_2 = P/\pi r_2^2 = H_1 (r_1/r_2)^2. \quad (8)$$

If the radius of lens 2 is the same as that of the MRD300 lens, then the net increase in irradiance (neglecting a small lens loss) will be a function of the square of the ratio of the radius of lens 1 and the radius of the MRD300 lens — nominally 0.075 inch.

If $r_1 = 0.5$ inch, then the previously computed irradiance (Eq. 5) increases to

$$H' = (0.115) (0.5/0.075)^2 = 5.1 \text{ mW/cm}^2. \quad (9)$$

Empirically losses caused by lens imperfections and misalignment average about 10% per lens. Thus the actual irradiance at the MRD300 is

$$H'' = (5.1) (0.81) = 4.45 \text{ mW/cm}^2. \quad (10)$$

From Figure 1c, the radiation sensitivity, S_{RCEO} , is 0.2 mA/mW/cm², so that the photocurrent is

$$I_C = (0.2) (4.45) = 828 \text{ } \mu\text{A,} \quad (11)$$

indicating that the gain of the two-lens system is about 120.

For more current, add an amplifier

Since the system is intended for assembly-line operation, a high-noise-immunity logic counter is needed to count the phototransistor pulses (Figure 3). The input termination of the MC672 that meets the noise requirements must sink up to 1.2 mA, or the output of the phototransistor given in Eq. 11 must be increased by about 50%. While such an increase can be obtained by raising the lamp voltage, the lamp life — inversely proportional to the cube of the lamp voltage — will be reduced. Thus a gain stage between the phototransistor and the counter should be added (Figure 3).

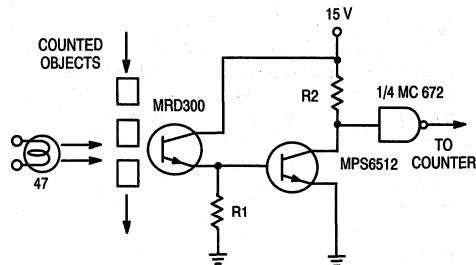

3. To meet the input-current requirements of an IC counter, a common-emitter amplifier is used to amplify the phototransistor current.

With the gain stage in, a noise current, I_n , in the phototransistor due to background lighting must be inhibited from introducing wrong counts.

To this end, the voltage across R_1 at the time an object blocks the light to the MRD300 is

$$V_{R1} = (R_1) (I_n + I_{CBO}), \quad (12)$$

where I_{CBO} is the worst-case base leakage current for the MPS6512 (0.05 μA at 25°C).

To keep the amplifier transistor safely OFF, the V_{R1} must be held below 0.2 V, and the value of $R1$ can be computed from

$$R1 = (0.2)/(I_n + I_{CBO}) \quad (13)$$

This $R1$ value is for 25°C operation. To provide for higher temperature environment, $R1$ might be reduced by a factor of 4. The noise current, I_n , required for determining $R1$ should be measured, since it depends on the system layout.

To determine the circuit ON requirements, consider the conditions when the light path is unblocked and the phototransistor current is 0.828 mA.

The base-emitter of the MPS6512 will clamp the voltage across $R1$ to about 0.7 V, so that

$$I_{R1} = (0.7)/(R1) \quad (14)$$

The MPS6512 base current will be

$$I_B = 0.828 \text{ mA} - I_{R1} \quad (15)$$

The collector current of the amplifier transistor will be the 1.2 mA required to drive the counter, plus the steady-state current through $R2$, chosen to be 1 mA. Since the total collector current is 2.2 mA maximum, the minimum h_{FE} of the amplifier transistor must be

$$h_{FE}(\text{min}) = (2.2 \text{ mA})/I_B \quad (16)$$

$$= (2.2 \text{ mA})/(0.828 \text{ mA} - I_{R1}) \quad (17)$$

$$= (2.2 \text{ mA})/[0.828 - (0.7/R1)] \quad (18)$$

And since the minimum specified h_{FE} of the MPS6512 is 50, the h_{FE} in Eq. 16 must always be less than 50 for saturated switching of the MPS6512. Also, note that the maximum permissible value of the noise current, I_n , in Eq. 13 can be determined from Eq. 18, which expresses h_{FE} in terms of $R1$.

Sense light from a solid-state source

If a GaAs light-emitting diode (LED) is used as a source, color temperature becomes meaningless: The LED output is essentially monochromatic. Thus determining the induced photocurrent becomes a problem in geometry.

Assuming the LED to be a point source with a divergence angle θ , we find that the area irradiated by the LED at a distance d will be as in Figure 4, and the divergence half angle is

$$\tan(\theta/2) = r/d, \quad (19)$$

so that

$$r = d \tan(\theta/2), \quad (20)$$

or, since for small angles the tangent is approximately equal to the

$$r \approx d(\theta/2). \quad (21)$$

The irradiated area thus becomes

$$A = \pi r^2 = \pi d^2 \theta^2 / 4. \quad (22)$$

If the total output power, P_T , of the LED is assumed to irradiate the area A , the surface irradiance is

$$H = P_T/A = 4P_T/\pi d^2 \theta^2. \quad (23)$$

Using Eq. 23 as an expression for irradiance, we can develop a procedure for determining photocurrent. Suppose a GaAs LED is used as the transmitter in an optically coupled switch, while an MRD300 is used as the receiver. The LED is driven by 500 mA, 5 μ s pulses, and it is one centimeter away from the detector.

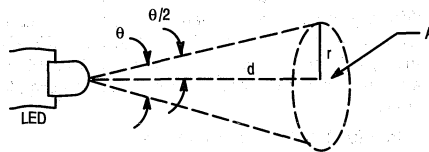

4. Area irradiated by a light-emitting diode (LED) can be computed from this sketch.

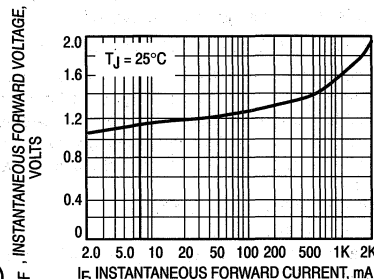

(a)

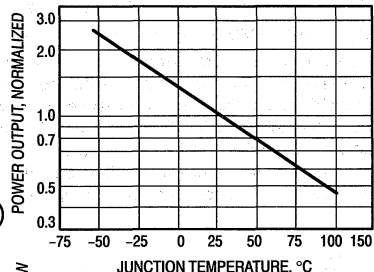

(b)

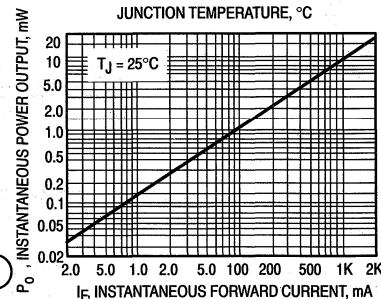

(c)

5. In predicting a phototransistor response to a LED, first determine the instantaneous power dissipation of the LED from "a", which is needed for calculating the corresponding junction temperature. With these data, you can determine the LED's power output by using curves "b" and "c" and a few simple calculations.

To determine the incident irradiance at the phototransistor, the LED power output must be determined first. Since it is a function of the average LED junction temperature, the junction temperature must also be computed.

Referring to Figure 5a, we see that the forward voltage V_F , across the LED at the current of 500 mA is about 1.45 V. If the worst-case duty cycle, D , is 10% and the ambient temperature, T_A , 25°C, the average junction temperature is

$$T_{J(av)} = T_A + \theta_{JA} V_F I_F D, \quad (24)$$

where the junction-to-ambient thermal resistance, θ_{JA} , is given in the data sheet as 500 C/W maximum. Thus the average junction temperature is

$$\begin{aligned} &= 25 + (500)(1.45)(0.5)(0.1) \\ &= 61.3^\circ\text{C}. \end{aligned} \quad (25)$$

As in Figure 5b, the LED's output power is down at this junction temperature to about 65% of its value at 25°C, or 4.8 mW (Figure 5c). Thus the actual power output is

$$P_T = (4.8)(0.65) = 3.12 \text{ mW}. \quad (26)$$

Since the values in Figure 5c are typical, the minimum value (about 30% of typical) is a more realistic figure, so that

$$P_T = (3.12)(0.3) = 0.94 \text{ mW}. \quad (27)$$

From Figure 6, the divergence angle for the MLED930 is about 30°, or 0.523 rad. Thus the incident irradiance at the phototransistor is from Eq. 23,

$$\begin{aligned} H &= (4)(0.94)/[(\pi)(0.523)^2(1 \text{ cm})^2] \\ &= 4.4 \text{ mW/cm}^2. \end{aligned} \quad (28)$$

To determine the phototransistor response to the LED, consider Figure 1c once more. Here the specified sensitivity of the transistor is given for a tungsten source at 2870°C. The radiation of this source is about 25% effective on the transistor, while the LED's 9000-Å output is 90% effective. Thus the transistor sensitivity to the LED, $S'R_{CEO}$, is

$$S'R_{CEO} = SR_{CEO} (0.9)/(0.25) = 3.6SR_{CEO}. \quad (29)$$

The minimum sensitivity of the MRD300 at the available irradiance (from a tungsten source) is about 0.2 mA/mW/cm². Thus the sensitivity to the LED is

$$\begin{aligned} S'R_{CEO} &= (3.6)(0.2) \\ &= 0.72 \text{ ma/mW/cm}^2, \end{aligned} \quad (30)$$

inducing the photocurrent of

$$I_C = (0.72)(4.4) = 3.17 \text{ mA}. \quad (31)$$

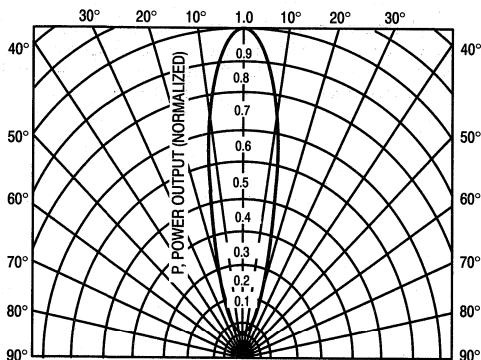

6. Divergence angle of a LED output is read directly from its radiation pattern, which is usually a part of manufacturers' data.

There are two sources of error in the calculation. One is due to the small-angle approximation (Eq. 21) that introduces an error of about 10%. The other is due to the small separation distance between the LED and the transistor (1 cm), resulting in the nonparallel rays at the transistor surface. Thus the photocurrent value calculated in Eq. 31 should be reduced by about 30%, or

$$I_C = 2.23 \text{ mA (minimum)}. \quad (32)$$

Compensate for temperature changes

Phototransistor temperature problems, while similar to those of other semiconductors, are further aggravated by their typically low output currents. For example, consider the application of the accepted approximation of leakage current doubling for every 10°C rise in temperature to the MRD300.

At 25°C, maximum I_{CEO} is 100 nA. At 85°C, this becomes about 6.5 µA. If the induced photocurrent is close to this value (as in the first example, Eq. 6), then the system might not be able to distinguish between the signal and no-signal conditions. Furthermore h_{FE} of the phototransistor also increases with temperature.

If the phototransistor is a three-lead device — that is it has an electrical connection to its base — the classical bias-stabilization circuit for a common-emitter transistor amplifier can be used, (Figure 7a). Its performance characteristics are somewhat different in the case of a phototransistor.

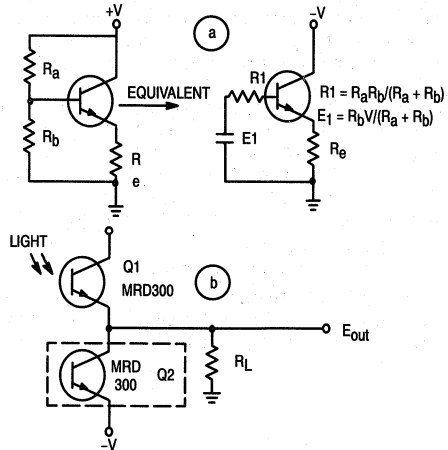

7. Temperature-compensation methods for a three-lead phototransistor are quite similar to a classical bias-stabilization approach (a). In the case of a two lead device, a matched pair of phototransistors can be used, one to receive the normal light input, while the other is masked (b).

The collector current is given by

$$I_C = \{h_{FE}(E_1 - E_0/[R_1 + (1 + h_{FE})R_E]) + \{I_{CEO}(R_1 + R_E)/[R_1 + (1 + h_{FE})R_E]\} \quad (33)$$

where $E_0 = V_{BE} = 0.7$ V.

Since $I_{CEO} = (1 + h_{FE}) I_{CO}$, Eq. 33 becomes

$$I_C = \{h_{FE}(E_1 - 0.7)/[R_1 + (1 + h_{FE})R_E]\} + \{I_{CO}(R_1 + R_E) (1 + h_{FE})/[R_1 + (1 + h_{FE})R_E]\}. \quad (34)$$

The two stability factors, S_1 and S_2 , are

$$S_1 = dI_C/dI_{CO}, \quad S_2 = dI_C/dh_{FE}. \quad (35)$$

Since the phototransistor cannot distinguish between I_{CO} and the collector-base photocurrent, S_1 should be maximized, but the h_{FE} variation should be reduced by minimizing S_2 . Thus the ratio S_1/S_2 should be maximized, or, omitting the arithmetic,

$$S_1/S_2 = (1 + h_{FE}) [R_1 + (1 + h_{FE})R_E] / [(E_1 - 0.7) + I_{CO}R_1]. \quad (36)$$

The examination of Eq. 36 suggests maximizing R_1 and R_E to maximize the ratio. Indeed, the effect of increasing R_1 will be more pronounced in the numerator, as desired. Furthermore larger R_1 results in better sensitivity. Maximizing R_E helps increase the output voltage.

In the case of a phototransistor without an electrical connection to the base (such as the MRD300, the circuit in Figure 7b can be used to compensate for temperature variations. Here two matched phototransistors are used, one to do the normal light sensing, while the other is kept in the dark all the time. Under zero-signal conditions both transistors pass I_{CEO} and no current flows through the load resistor, R_L , so that the output remains at zero. When a light signal is applied, photocurrent flows through Q1 and R_L , thus developing the desired output. The two matched transistors can also be operated as a differential pair, and the thermal effects will be nulled as will all other common-mode signals.

Because of the large collector-base capacitance (which, in turn, is due to the large active area of the base), phototransistors generally have a limited frequency response. Furthermore the response depends on the load resistance. If the load is in the emitter circuit, the R_L is reflected into the base circuit as $(1 + h_{FE})R_L$. The time constant for this case is

$$\tau = (1 + h_{FE}) R_L C_{CB}, \quad (37)$$

where C_{CB} is the collector-base capacitance.

As the load resistance is increased to raise the output voltage, the time constant also increases, and the frequency response falls off rapidly (Figure 8).

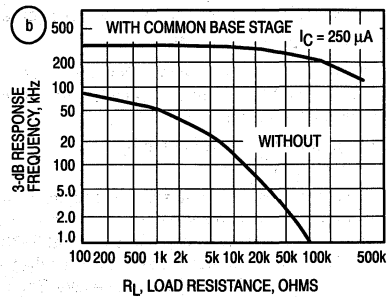
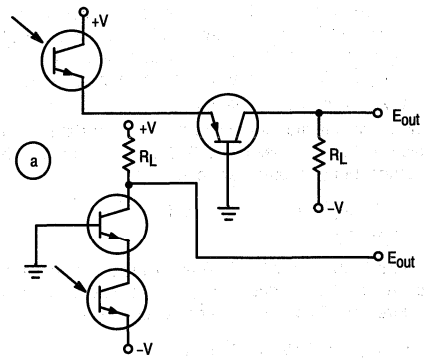

8. Improved frequency response of a phototransistor is obtained with a common-base load-impedance transforming network (a) in either the collector or emitter circuit. The degree of the improvement is shown in "b".

If the load resistor is in the collector circuit, an equivalent voltage gain, A_V , becomes proportional to R_L . The Miller capacitance at the input is thus

$$C_{in} = C_{CB} A_V,$$

so that here again raising R_L results in decreased frequency response.

High-load resistance and an improved frequency response can be obtained with a simple impedance-transforming network (Figure 8). Note that the frequency response for one of such networks in Figure 8 remains flat for R_L to 50 kΩ.

ISOLATION TECHNIQUES USING OPTICAL COUPLERS

Prepared by
Francis Christian

INTRODUCTION

The optical coupler is a new device that offers the design engineer new freedoms in designing circuits and systems. Problems such as ground loop isolation, common mode noise rejection, power supply transformations, and many more problems can be solved or simplified with the use of an optical coupler.

Operation is based on the principle of detecting emitted light. The input to the coupler is connected to a light emitter and the output is a photodetector, the two elements being separated by a transparent insulator and housed in a light-excluding package. There are many types of optical couplers; for example, the light source could be an incandescent lamp or a light emitting diode (LED). Also, the detector could be photovoltaic cell, photoconductive cell, photodiode, phototransistor, or a light-sensitive SCR. By various combinations of emitters and detectors, a number of different types of optical couplers could be assembled.

Once an emitter and detector have been assembled as a coupler, the optical portion is permanently established so that device use is only electronic in nature. This eliminates the need for the circuit designer to have knowledge of optics. However, for effective application, he must know something of the electrical characteristics, capabilities, and limitations, of the emitter and detector.

COUPLER CHARACTERISTICS

The 4N25 is an optical coupler consisting of a gallium arsenide (GaAs) LED and a silicon phototransistor. (For more information on LEDs and phototransistors, see References 1 and 2).

The coupler's characteristics are given in the following sequence: LED characteristics, phototransistor characteristics, coupled characteristics, and switching characteristics. Table I shows all four for the 4N25 series.

INPUT

For most applications the basic LED parameters I_F and V_F are all that are needed to define the input. Figure 1 shows these forward characteristics, providing the necessary information to design the LED drive circuit. Most circuit applications will require a current limiting resistor in series with the LED input. The circuit in Figure 2 is a typical drive circuit.

The current limiting resistor can be calculated from the following equation:

$$R = \frac{V_{IN} - V_F}{I_F}$$

where

V_F = diode forward voltage
 I_F = diode forward current

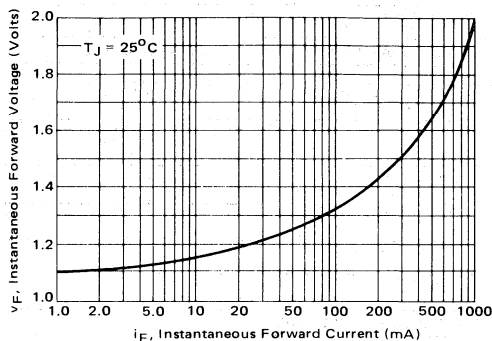

FIGURE 1 — Input Diode Forward Characteristic

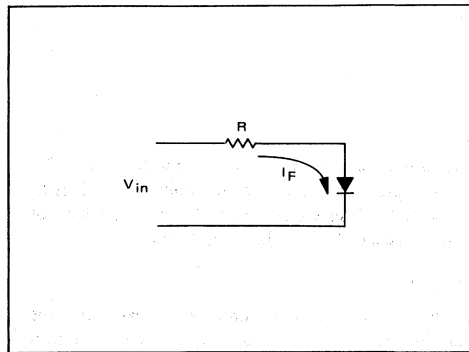

FIGURE 2 — Simple Drive Circuit For An LED

AN571A

TABLE I

LED CHARACTERISTICS (T _A = 25°C unless otherwise noted)					
Characteristic	Symbol	Min	Typ	Max	Unit
*Reverse Leakage Current (V _R = 3.0 V, R _L = 1.0 M ohms)	I _R	—	0.05	100	μA
*Forward Voltage (I _F = 50 mA)	V _F	—	1.2	1.5	Volts
Capacitance (V _R = 0 V, f = 1.0 MHz)	C	—	150	—	pF

PHOTOTRANSISTOR CHARACTERISTICS (T _A = 25°C and I _F = 0 unless otherwise noted)					
Characteristic	Symbol	Min	Typ	Max	Unit
*Collector-Emitter Dark Current (V _{CE} = 10 V, Base Open)	I _{CEO}	—	3.5	50	nA
*Collector-Base Dark Current (V _{CB} = 10 V, Emitter Open)	I _{CBO}	—	—	20	nA
*Collector-Base Breakdown Voltage (I _C = 100 μA, I _E = 0)	V(BR)CBO	70	—	—	Volts
*Collector-Emitter Breakdown Voltage (I _C = 1.0 mA, I _B = 0)	V(BR)CEO	30	—	—	Volts
*Emitter-Collector Breakdown Voltage (I _E = 100 μA, I _B = 0)	V(BR)ECO	7.0	—	—	Volts
DC Current Gain (V _{CE} = 5.0 V, I _C = 500 μA)	h _{FE}	—	250	—	—

COUPLED CHARACTERISTICS (T _A = 25°C unless otherwise noted)					
Characteristic	Symbol	Min	Typ	Max	Unit
*Collector Output Current (1) (V _{CE} = 10 V, I _F = 10 mA, I _B = 0)	I _C	2.0 1.0	5.0 3.0	—	mA
*Isolation Voltage (2)	V _{ISO}	2500 1500 500	—	—	Volts
Isolation Resistance (2) (V = 500 V)	—	—	10 ¹¹	—	Ohms
*Collector-Emitter Saturation (I _C = 2.0 mA, I _F = 50 mA)	V _{CE(sat)}	—	0.2	0.5	Volts
Isolation Capacitance (2) (V = 0, f = 1.0 MHz)	—	—	1.3	—	pF
Bandwidth (3) (I _C = 2.0 mA, R _L = 100 ohms, Figure 11)	—	—	300	—	kHz

SWITCHING CHARACTERISTICS					
Characteristic	Symbol	Min	Typ	Max	Unit
Delay Time (I _C = 10 mA, V _{CC} = 10 V)	t _d	—	0.07 0.10	—	μs
Rise Time (Figures 6 and 8)	t _r	—	0.8 2.0	—	μs
Storage Time (I _C = 10 mA, V _{CC} = 10 V)	t _s	—	4.0 2.0	—	μs
Fall Time (Figures 7 and 8)	t _f	—	7.0 3.0	—	μs

*Indicates JEDEC Registered Data. (1) Pulse Test. Pulse Width = 300 μs, Duty Cycle ≤ 2.0%.
 (2) For this test LED pins 1 and 2 are common and Photo Transistor pins 4, 5 and 6 are common.
 (3) I_F adjusted to yield I_C = 2.0 mA and t_c = 2.0 mA @ p at 10 kHz.

11

OUTPUT

The output of the coupler is the phototransistor. The basic parameters of interest are the collector current I_C and collector emitter voltage, V_{CE}. Figure 3 is a curve of V_{CE(sat)} versus I_C for two different drive levels.

COUPLING

To fully characterize the coupler, a new parameter, the dc current transfer ratio or coupling efficiency (η) must be defined. This is the ratio of the transistor collector current to diode current I_C/I_F. Figures 4A and 4B show the typical dc current transfer functions for the couplers at V_{CE} = 10 volts. Note that η varies with I_F and V_{CE}.

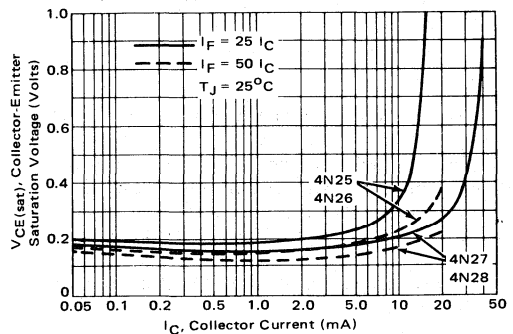

FIGURE 3 — Collector Saturation Voltage

Once the required output collector current I_C is known, the input diode current can be calculated by

$$I_F = I_C / \eta,$$

where I_F is the forward diode current
 I_C is the collector current
 η is the coupling efficiency or transfer ratio.

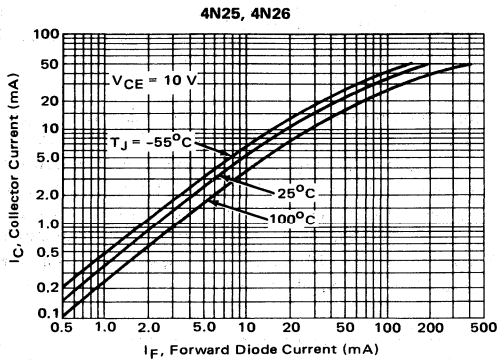

FIGURE 4A – DC Current Transfer Ratio

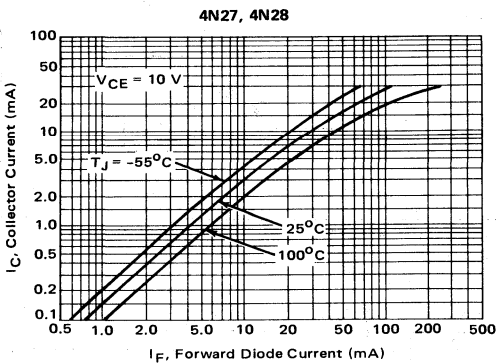

FIGURE 4B – DC Current Transfer Ratio

RESPONSE TIME

The switching times for the couplers are shown in Figures 5A and 5B. The speed is fairly slow compared to switching transistors, but is typical of phototransistors because of the large base-collector area. The switching time or bandwidth of the coupler is a function of the load resistor R_L because of the $R_L C_O$ time constant where C_O is the parallel combination of the device and load capacitances. Figure 6 is a curve of frequency response versus R_L .

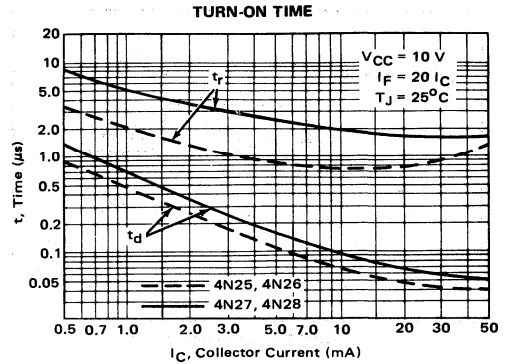

FIGURE 5A – Switching Times

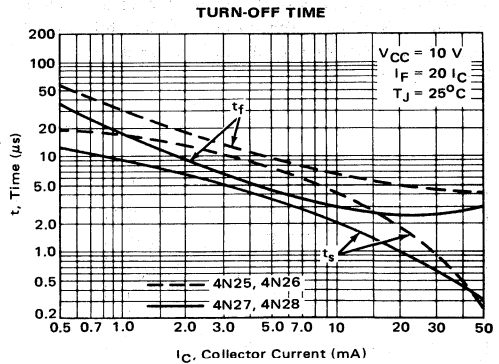

FIGURE 5B – Switching Times

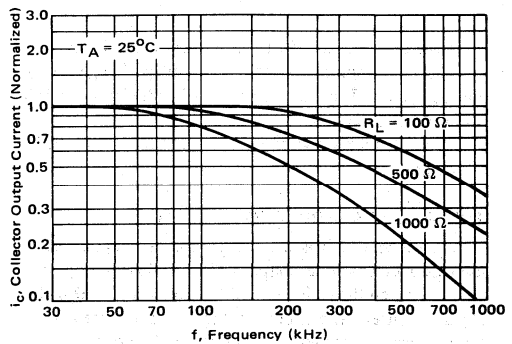

FIGURE 6 – Frequency Response

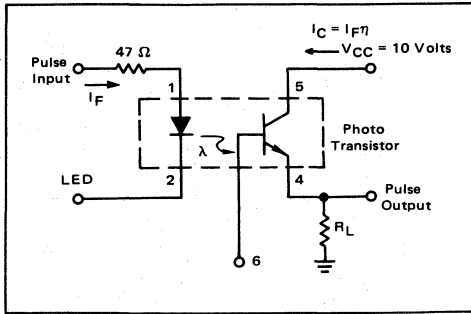

FIGURE 7 – Pulse Mode Circuit

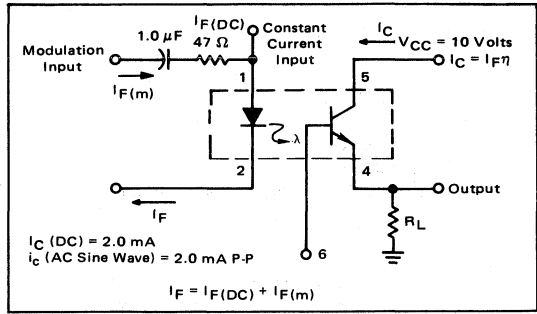

FIGURE 8 – Linear Mode Circuit

OPERATING MODE

The two basic modes of operation are pulsed and linear. In the pulsed mode of operation, the LED will be switched on or off. The output will also be pulses either in phase or 180° out of phase with the input depending on where the output is taken. The output will be 180° out of phase if the collector is used and in phase if the emitter is used for the output.

time for a diode-transistor coupler is in the order of 2 to 5 μs, where the diode-diode coupler is 50 to 100 ns. The one disadvantage with the diode-diode coupler is that the output current is much lower than the diode-transistor coupler. This is because the base current is being used as signal current and the β multiplication of the transistor is omitted. Figure 10 is a graph of IB versus IF using the coupler in the diode-diode mode.

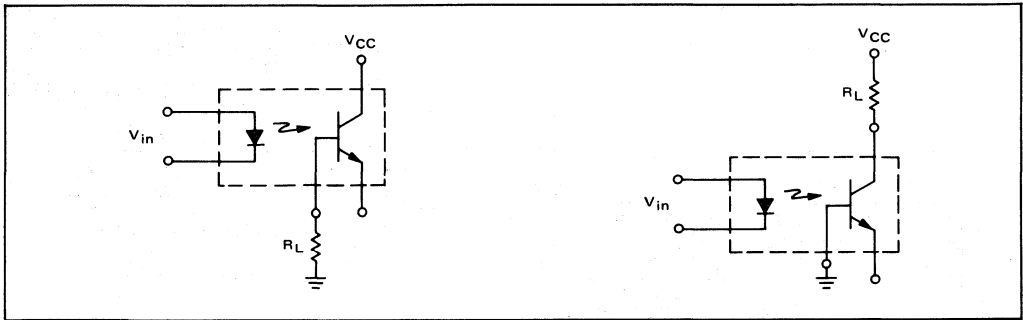

FIGURE 9 – Circuit Connections for Using the 4N26 As a Diode-Diode Coupler

In the linear mode of operation, the input is biased at a dc operating point and then the input is changed about this dc point. The output signal will have an ac and dc component in the signal.

Figures 7 and 8 show typical circuits for the two modes of operation.

THE 4N26 AS A DIODE-DIODE COUPLER

The 4N26 which is a diode-transistor coupler, can be used as a diode-diode coupler. To do this the output is taken between the collector and base instead of the collector and emitter. The circuits in Figure 9 show the connections to use the coupler in the diode-diode mode.

The advantage of using the 4N26 as a diode-diode coupler is increased speed. For example, the pulse rise

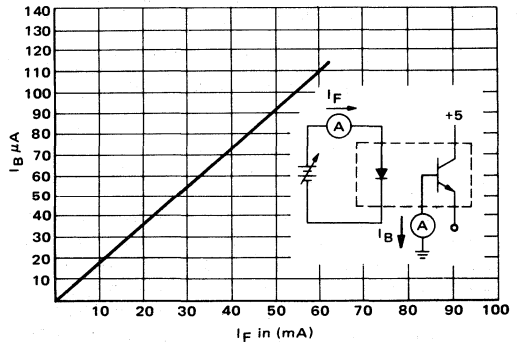

FIGURE 10 – IB versus IF Curve for Using the 4N26 As a Diode-Diode Coupler

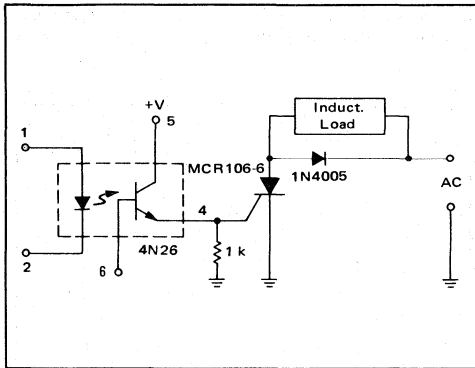

FIGURE 11 – Coupler-Driven SCR

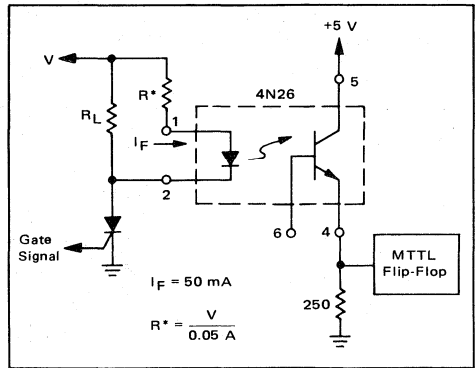

FIGURE 12 – Opto Coupler In A Load To Logic Translation

APPLICATIONS

The following circuits are presented to give the designer ideas of how the 4N26 can be used. The circuits have been bread-boarded and tested, but the values of the circuit components have not been selected for optimum performance over all temperatures.

Figure 11 shows a coupler driving a silicon controlled rectifier (SCR). The SCR is used to control an inductive load, and the SCR is driven by a coupler. The SCR used is a sensitive gate device that requires only 1 mA of gate current and the coupler has a minimum current transfer ratio of 0.2 so the input current to the coupler, I_F , need only be 5 mA. The 1 k resistor connected to the gate of the SCR is used to hold off the SCR. The 1N4005 diode is used to suppress the self-induced voltage when the SCR turns off.

Figure 12 is a circuit that couples a high voltage load to a low voltage logic circuit. To insure that the voltage to the MTTL flip-flop exceeds the logic-one level, the coup-

ler output current must be at least 10 mA. To guarantee 10 mA of output current, the input current to the LED must be 50 mA. The current limiting resistor R can be calculated from the equation $R = \frac{V - V_F}{0.05}$. If the power supply voltage, V, is much greater than V_F , the equation for R reduces to $R = \frac{V}{0.05}$.

The circuit of Figure 13 shows a coupler driving an operational amplifier. In this application an ac signal is passed through the coupler and then amplified by the op amp. To pass an ac signal through the coupler with minimum distortion, it is necessary to bias the LED with a dc current. The ac signal is summed with the dc current so the output voltage of the coupler will have an ac and a dc component. Since the op amp is capacitively coupled to the coupler, only the ac signal will appear at the output.

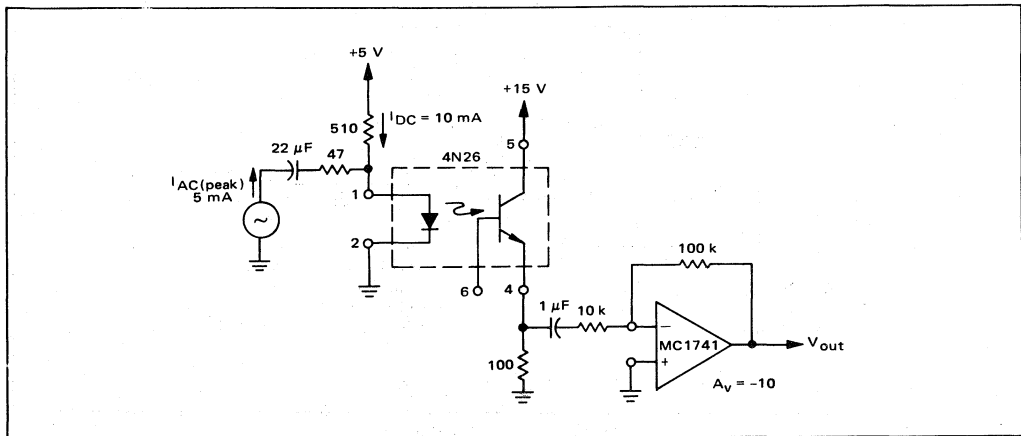

FIGURE 13 – Coupling An AC Signal to an Operational Amplifier

AN571A

The circuit of Figure 14 shows the 4N26 being used as a diode-diode coupler, the output being taken from the collector-base diode. In this mode of operation, the emitter is left open, the load resistor is connected between the base and ground, and the collector is tied to the positive voltage supply. Using the coupler in this way reduces the switching time from 2 to 3 μs to 100 ns.

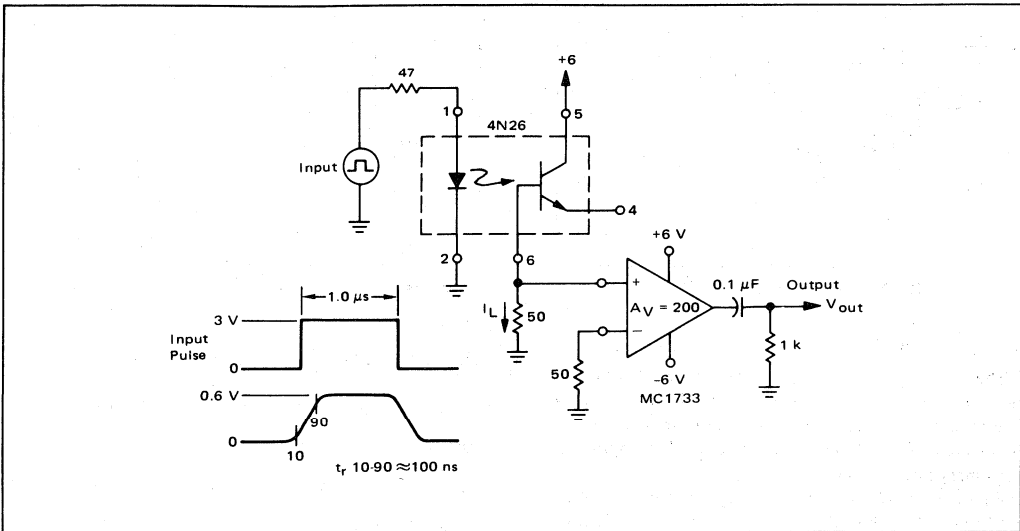

FIGURE 14 — Using the 4N26 as a Diode-Diode Coupler

The circuit of Figure 15 is a standard two-transistor one-shot, with one transistor being the output transistor of the coupler. The trigger to the one-shot is the LED input to the coupler. A pulse of 3 μs in duration and 15 mA will trigger the circuit. The output pulse width (PW_O) is equal to $0.7 RC + PW_I + 6 \mu\text{s}$ where PW_I is the input pulse width and 6 μs is the turn-off delay of the coupler. The amplitude of the output pulse is a function of the power supply voltage of the output side and independent of the input.

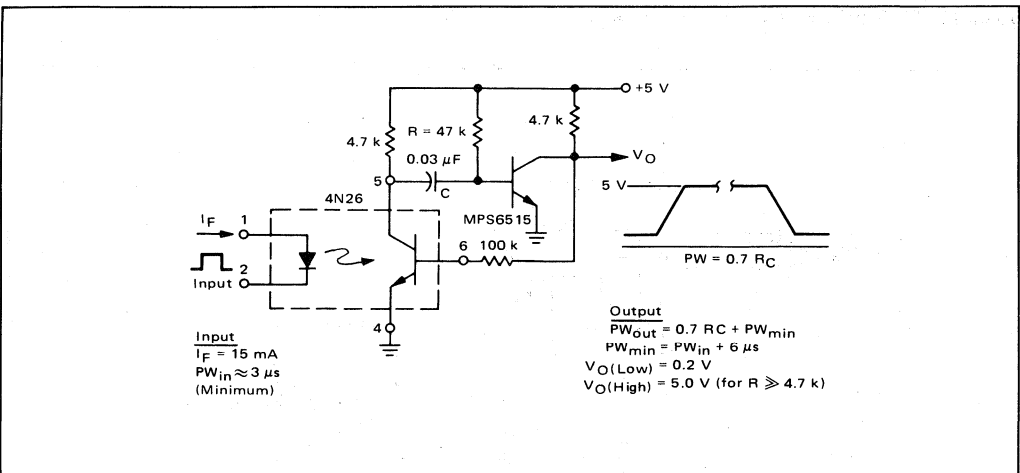

FIGURE 15 — Pulse Stretcher

AN571A

The circuit of Figure 16 is basically a Schmitt trigger. One of the Schmitt trigger transistors is the output transistor of a coupler. The input to the Schmitt trigger is the LED of the coupler. When the base voltage of the coupler's transistor exceeds $V_e + V_{be}$ the output transistor of

the coupler will switch on. This will cause Q2 to conduct and the output will be in a high state. When the input to the LED is removed, the coupler's output transistor will shut off and the output voltage will be in a low state. Because of the high impedance in the base of the coupler

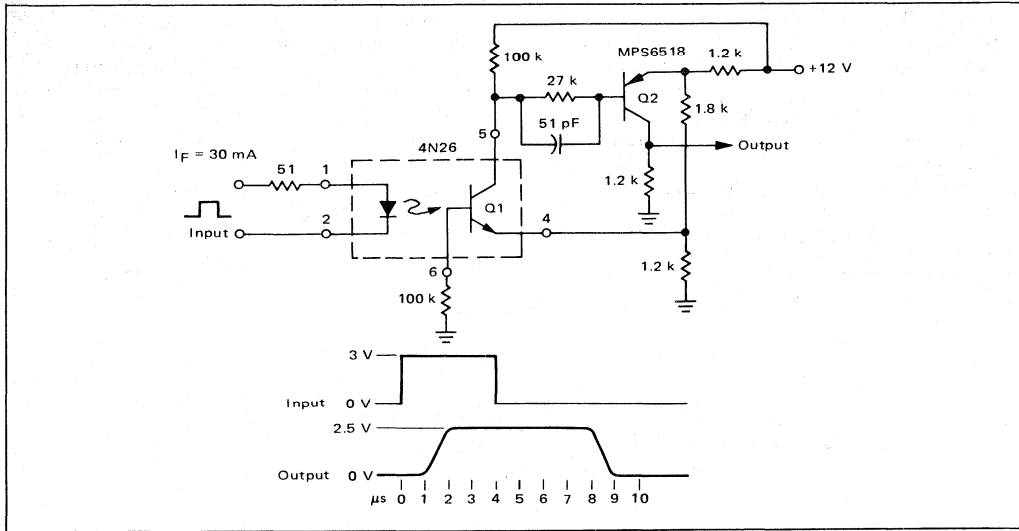

FIGURE 16 – Optically Coupled Schmitt Trigger

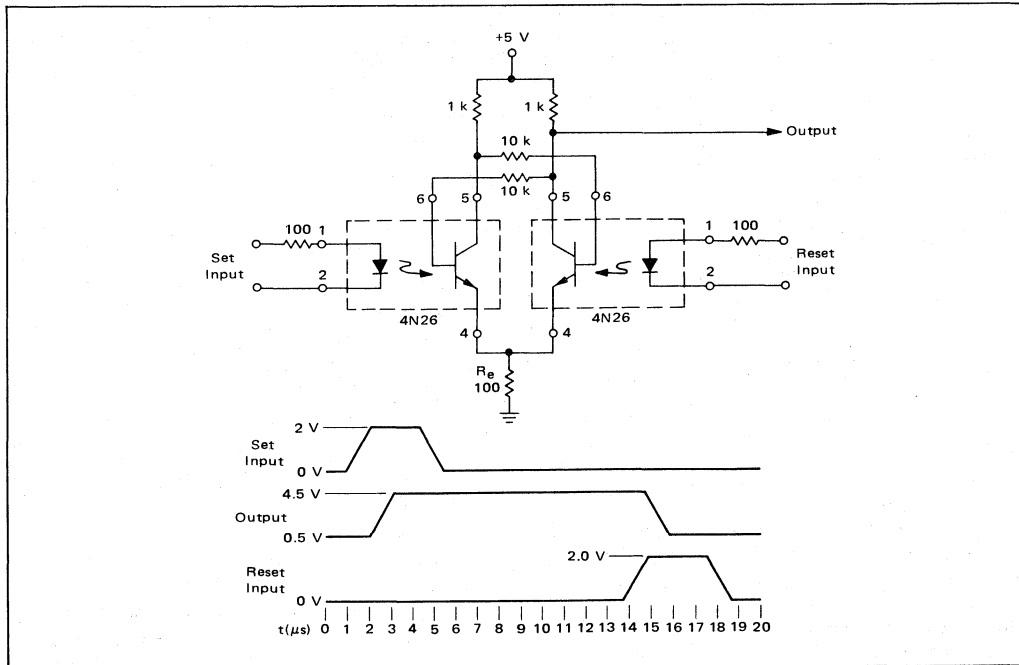

FIGURE 17 – Optically Coupled R-S Flip-Flop

transistor, the turn-off delay is about 6 μ s. The high base impedance (100 k ohms) represents a compromise between sensitivity (input drive required) and frequency response. A low value base resistor would improve speed but would also increase the drive requirements.

The circuit in Figure 17 can be used as an optically coupled R-S flip-flop. The circuit uses two 4N26 couplers cross coupled to produce two stable states. To change the output from a low state to a high state requires a positive 2 V pulse at the set input. The minimum width of the set pulse is 3 μ s. To switch the output back to the low state needs only a pulse on the reset input. The reset-operation is similar to the set operation.

Motorola integrated voltage regulators provide an input

for the express purpose of shutting the regulator off. For large systems, various subsystems may be placed in a standby mode to conserve power until actually needed. Or the power may be turned OFF in response to occurrences such as overheating, over-voltage, shorted output, etc.

With the use of the 4N26 optically coupled, the regulator can be shut down while the controlling signal is isolated from the regulator. The circuit of Figure 18 shows a positive regulator connected to an optical coupler.

To insure that the drive to the regulator shut down control is 1 mA, (the required current), it is necessary to drive the LED in the coupler with 5 mA of current, an adequate level for logic circuits.

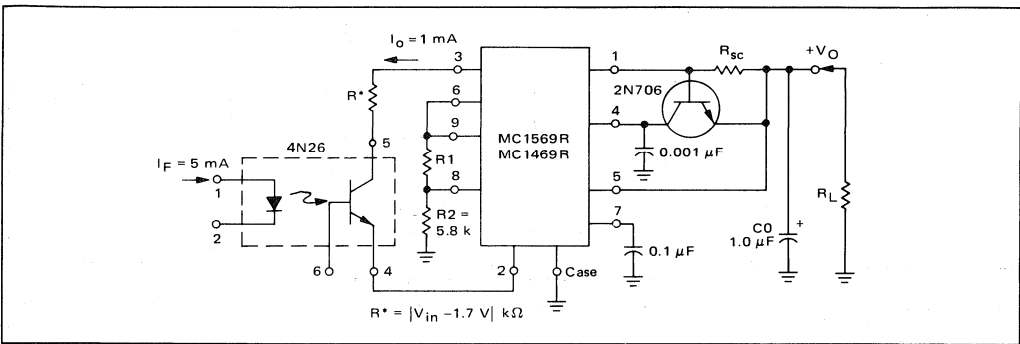

FIGURE 18 — Optical Coupler Controlling the Shut Down of MC1569 Voltage Regulator

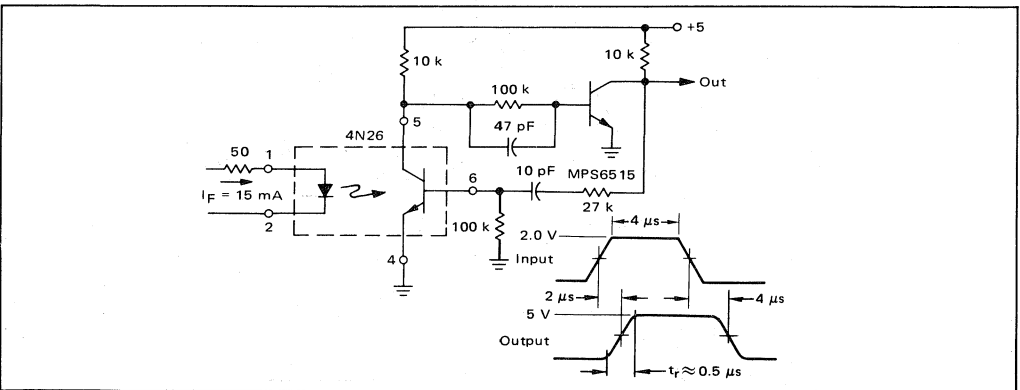

FIGURE 19 — Simple Pulse Amplifier

The circuit in Figure 19 is a simple pulse amplifier using positive, ac feedback into the base of the 4N26. The advantage of the feedback is in faster switching time. Without the feedback, the pulse rise time is about 2.0 μ s, but with the positive feedback, the pulse rise time is about 0.5 μ s. Figure 17A shows the input and output waveforms of the pulse amplifier.

REFERENCES

1. "Theory and Characteristics of Phototransistors," Motorola Application Note AN-440.
2. "Motorola Switching Transistor Handbook."
3. Deboo, G.J. and C.N. Burrous, Integrated Circuits and Semiconductor Devices Theory and Application, McGraw-Hill, 1971.

APPLICATIONS OF THE MOC3011 TRIAC DRIVER

Prepared by:
Pat O'Neil

DESCRIPTIONS OF THE MOC3011

Construction

The MOC3011 consists of a gallium arsenide infrared LED optically exciting a silicon detector chip, which is especially designed to drive triacs controlling loads on the 115 Vac power line. The detector chip is a complex device which functions in much the same manner as a small triac, generating the signals necessary to drive the gate of a larger triac. The MOC3011 allows a low power exciting signal to drive a high power load with a very small number of components, and at the same time provides practically complete isolation of the driving circuitry from the power line.

Basic Electrical Description

The GaAs LED has nominal 1.3 V forward drop at 10 mA and a reverse breakdown voltage greater than 3 V. The maximum current to be passed through the LED is 50 mA.

The detector has a minimum blocking voltage of 250 Vdc in either direction in the off state. In the on state, the detector will pass 100 mA in either direction with less than 3 V drop across the device. Once triggered into the on (conducting) state, the detector will remain there until the current drops below the holding current (typically 100 μ A) at which time the detector reverts to the off (non-conducting) state. The detector may be triggered into the on state by exceeding the forward blocking voltage, by voltage ramps across the detector at rates exceeding the static dv/dt rating, or by photons from the LED. The LED is guaranteed by the specifications to trigger the detector into the on state when 10 mA or more is passed through the LED. A similar device, the MOC3010, has exactly the same characteristics except it requires 15 mA to trigger.

Since the MOC3011 looks essentially like a small optically triggered triac, we have chosen to represent it as shown on Figure 2.

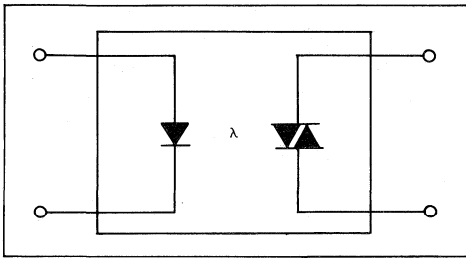

FIGURE 2 – Schematic Representation of MOC3011 and MOC3010

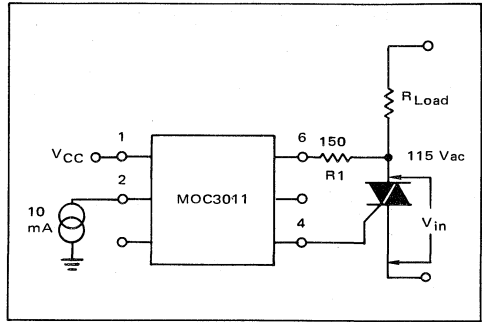

FIGURE 3 – Simple Triac Gating Circuit

USING THE MOC3011 AS A TRIAC DRIVER

Triac Driving Requirements

Figure 3 shows a simple triac driving circuit using the MOC3011. The maximum surge current rating of the MOC3011 sets the minimum value of R1 through the equation:

$$R1(\min) = V_{in(pk)} / 1.2 A$$

If we are operating on the 115 Vac nominal line voltage, $V_{in(pk)} = 180 V$, then

$$R1(\min) = V_{in(pk)} / 1.2 A = 150 \text{ ohms.}$$

In practice, this would be a 150 or 180 ohm resistor. If the triac has $I_{GT} = 100 \text{ mA}$ and $V_{GT} = 2 V$, then the voltage V_{in} necessary to trigger the triac will be given by $V_{inT} = R1 \cdot I_{GT} + V_{GT} + V_{TM} = 20 V$.

Resistive Loads

When driving resistive loads, the circuit of Figure 3 may be used. Incandescent lamps and resistive heating elements are the two main classes of resistive loads for which 115 Vac is utilized. The main restriction is that the triac must be properly chosen to sustain the proper inrush loads. Incandescent lamps can sometimes draw a peak current known as "flashover" which can be extremely high, and the triac should be protected by a fuse or rated high enough to sustain this current.

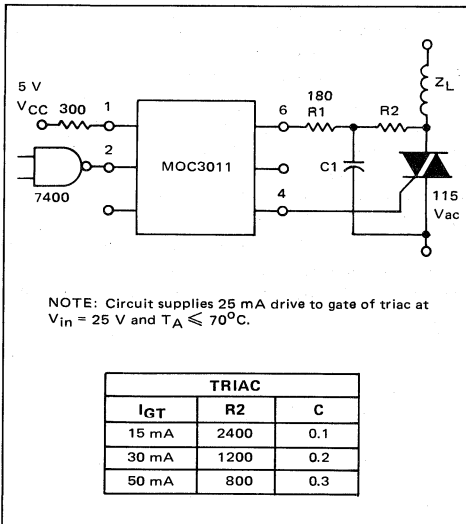

FIGURE 4 – Logic to Inductive Load Interface

Line Transients—Static dv/dt

Occasionally transient voltage disturbance on the ac line will exceed the static dv/dt rating of the MOC3011. In this case, it is possible that the MOC3011 and the associated triac will be triggered on. This is usually not a problem, except in unusually noisy environments, because the MOC3011 and its triac will commute off at the next zero crossing of the line voltage, and most loads are not noticeably affected by an occasional single half-cycle of applied power. See Figure 5 for typical dv/dt versus temperature curves.

Inductive Loads—Commutating dv/dt

Inductive loads (motors, solenoids, magnets, etc.) present a problem both for triacs and for the MOC3011 because the voltage and current are not in phase with each other. Since the triac turns off at zero current, it may be trying to turn off when the applied current is zero but the applied voltage is high. This appears to the triac like a sudden rise in applied voltage, which turns on the triac if the rate of rise exceeds the commutating dv/dt of the triac or the static dv/dt of the MOC3011.

Snubber Networks

The solution to this problem is provided by the use of "snubber" networks to reduce the rate of voltage rise seen by the device. In some cases, this may require two snubbers—one for the triac and one for the MOC3011. The triac snubber is dependent upon the triac and load used and will not be discussed here. In many applications

the snubber used for the MOC3011 will also adequately protect the triac.

In order to design a snubber properly, one should really know the power factor of the reactive load, which is defined as the cosine of the phase shift caused by the load. Unfortunately, this is not always known, and this makes snubbing network design somewhat empirical. However a method of designing a snubber network may be defined, based upon a typical power factor. This can be used as a "first cut" and later modified based upon experiment.

Assuming an inductive load with a power factor of PF = 0.1 is to be driven. The triac might be trying to turn off when the applied voltage is given by

$$V_{to} = V_{pk} \sin \phi \approx V_{pk} \approx 180 \text{ V}$$

First, one must choose R1 (Figure 4) to limit the peak capacitor discharge current through the MOC3011. This resistor is given by

$$R1 = V_{pk} / I_{max} = 180 / 1.2 \text{ A} = 150 \Omega$$

A standard value, 180 ohm resistor can be used in practice for R1.

It is necessary to set the time constant for $\tau = R_2 C$. Assuming that the triac turns off very quickly, we have a peak rate of rise at the MOC3011 given by

$$dv/dt = V_{to} / \tau = V_{to} / R_2 C$$

Setting this equal to the worst case dv/dt (static) for the MOC3011 which we can obtain from Figure 5 and solving for R₂C:

$$dv/dt (T_J = 70^\circ\text{C}) = 0.8 \text{ V}/\mu\text{s} = 8 \times 10^5$$

$$R_2 C = V_{to} / (dv/dt) = 180 / (8 \times 10^5) \approx 230 \times 10^{-6}$$

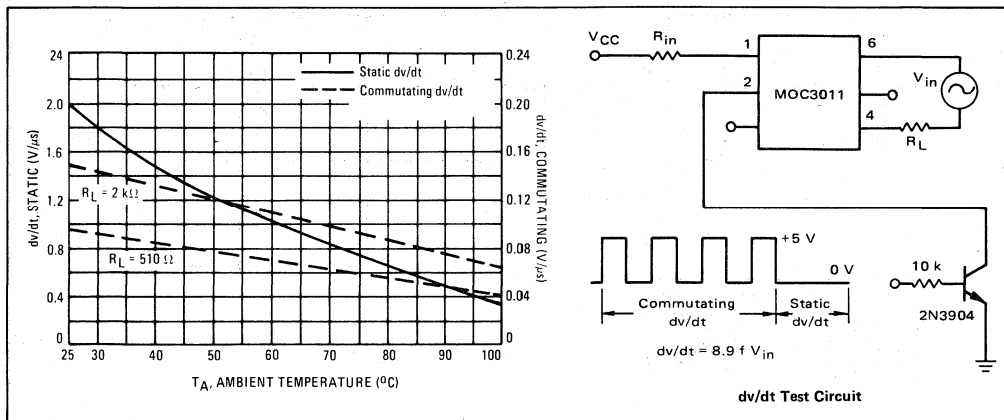

FIGURE 5 — dv/dt versus Temperature

The largest value of R2 available is found, taking into consideration the triac gate requirements. If a sensitive gate triac is used, such as a 2N6071B, $I_{GT} = 15 \text{ mA}$ @ -40°C . If the triac is to be triggered when $V_{in} \leq 40 \text{ V}$

$$(R1 + R2) \approx V_{in}/I_{GT} \approx 40/0.015 \approx 2.3 \text{ k}$$

If we let $R2 = 2400 \text{ ohms}$ and $C = 0.1 \mu\text{F}$, the snubbing requirements are met. Triacs having less sensitive gates will require that R2 be lower and C be correspondingly higher as shown in Figure 4.

INPUT CIRCUITRY

Resistor Input

When the input conditions are well controlled, as for example when driving the MOC3011 from a TTL, DTL, or HTL gate, only a single resistor is necessary to interface the gate to the input LED of the MOC3011. This resistor should be chosen to set the current into the LED to be a minimum of 10 mA but no more than 50 mA. 15 mA is a suitable value, which allows for considerable degradation of the LED over time, and assures a long operating life for the coupler. Currents higher than 15 mA do not improve performance and may hasten the aging process inherent in LED's. Assuming the forward drop to be 1.5 V at

15 mA allows a simple formula to calculate the input resistor.

$$R_i = (V_{CC} - 1.5)/0.015$$

Examples of resistive input circuits are seen in Figures 2 and 6.

Increasing Input Sensitivity

In some cases, the logic gate may not be able to source or sink 15 mA directly. CMOS, for example, is specified to have only 0.5 mA output, which must then be increased to drive the MOC3011. There are numerous ways to increase this current to a level compatible with the MOC3011 input requirements; an efficient way is to use the MC14049B shown in Figure 6. Since there are six such buffers in a single package, the user can have a small package count when using several MOC3011's in one system.

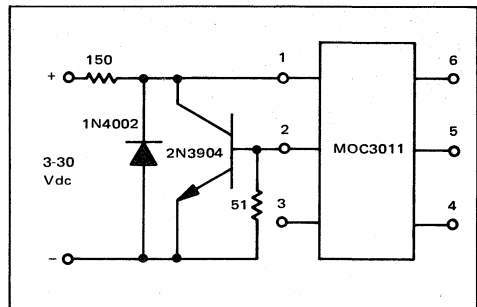

FIGURE 7 – MOC3011 Input Protection Circuit

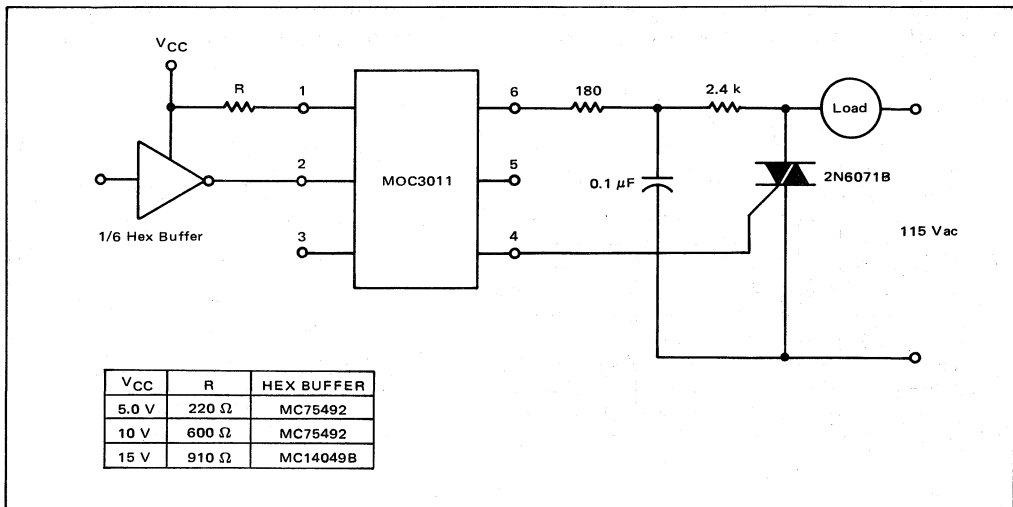

FIGURE 6 – MOS to ac Load Interface

Input Protection Circuits

In some applications, such as solid state relays, in which the input voltage varies widely the designer may want to limit the current applied to the LED of the MOC3011. The circuit shown in Figure 7 allows a non-critical range of input voltages to properly drive the MOC3011 and at the same time protects the input LED from inadvertent application of reverse polarity.

LED Lifetime

All light emitting diodes slowly decrease in brightness during their useful life, an effect accelerated by high temperatures and high LED currents. To allow a safety margin and insure long service life, the MOC3011 is actually tested to trigger at a value lower than the specified 10 mA input threshold current. The designer can therefore design the input circuitry to supply 10 mA to the LED and still be sure of satisfactory operation over

a long operating lifetime. On the other hand, care should be taken to insure that the maximum LED input current (50 mA) is not exceeded or the lifetime of the MOC3011 may be shortened.

APPLICATIONS EXAMPLES

Using the MOC3011 on 240 Vac Lines

The rated voltage of a MOC3011 is not sufficiently high for it to be used directly on 240 Vac line; however, the designer may stack two of them in series. When used this way, two resistors are required to equalize the voltage dropped across them as shown in Figure 8.

Remote Control of ac Voltage

Local building codes frequently require all 115 Vac light switch wiring to be enclosed in conduit. By using a MOC3011, a triac, and a low voltage source, it is

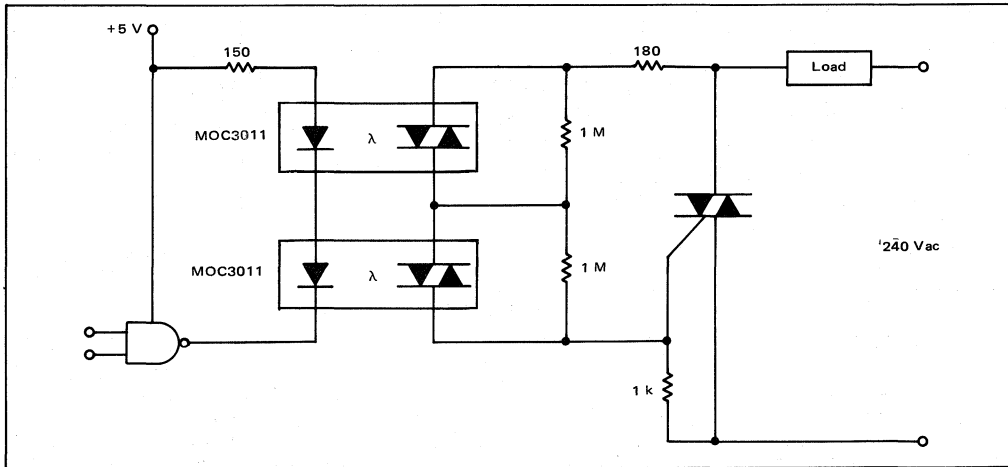

FIGURE 8 — 2 MOC3011 Triac Drivers in Series to Drive 240 V Triac

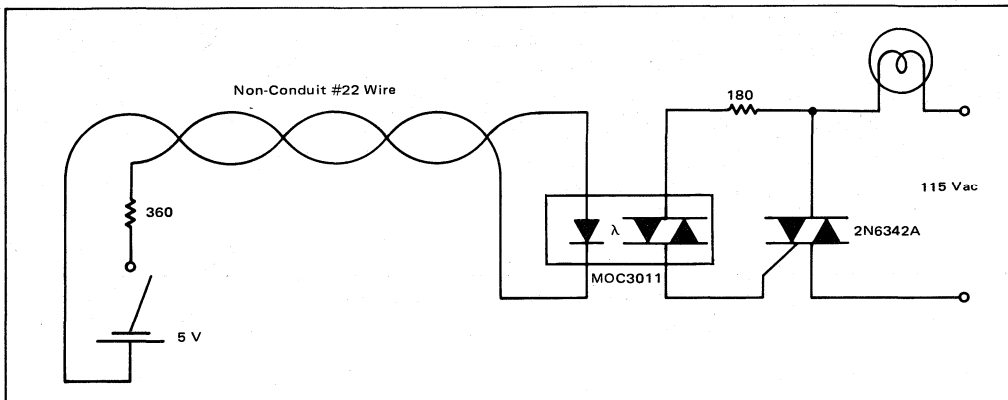

FIGURE 9 — Remote Control of ac Loads Through Low Voltage Non-Conduit Cable

possible to control a large lighting load from a long distance through low voltage signal wiring which is completely isolated from the ac line. Such wiring usually is not required to be put in conduit, so the cost savings in installing a lighting system in commercial or residential buildings can be considerable. An example is shown in Figure 9. Naturally, the load could also be a motor, fan, pool pump, etc.

Solid State Relay

Figure 10 shows a complete general purpose, solid state relay snubbed for inductive loads with input protection. When the designer has more control of the input and output conditions, he can eliminate those components which are not needed for his particular application to make the circuit more cost effective.

Interfacing Microprocessors to 115 Vac Peripherals

The output of a typical microcomputer input-output

(I/O) port is a TTL-compatible terminal capable of driving one or two TTL loads. This is not quite enough to drive the MOC3011, nor can it be connected directly to an SCR or triac, because computer common is not normally referenced to one side of the ac supply. Standard 7400 series gates can provide an input compatible with the output of an MC6820, MC6821, MC6846 or similar peripheral interface adaptor and can directly drive the MOC3011. If the second input of a 2 input gate is tied to a simple timing circuit, it will also provide energization of the triac only at the zero crossing of the ac line voltage as shown in Figure 11. This technique extends the life of incandescent lamps, reduces the surge current strains on the triac, and reduces EMI generated by load switching. Of course, zero crossing can be generated within the microcomputer itself, but this requires considerable software overhead and usually just as much hardware to generate the zero-crossing timing signals.

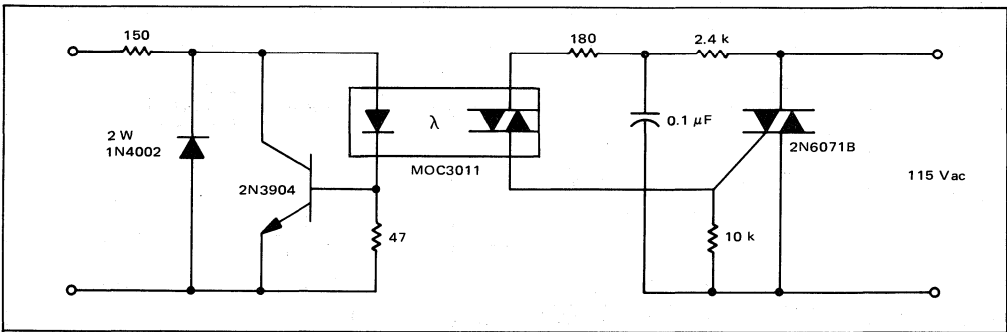

FIGURE 10 - Solid-State Relay

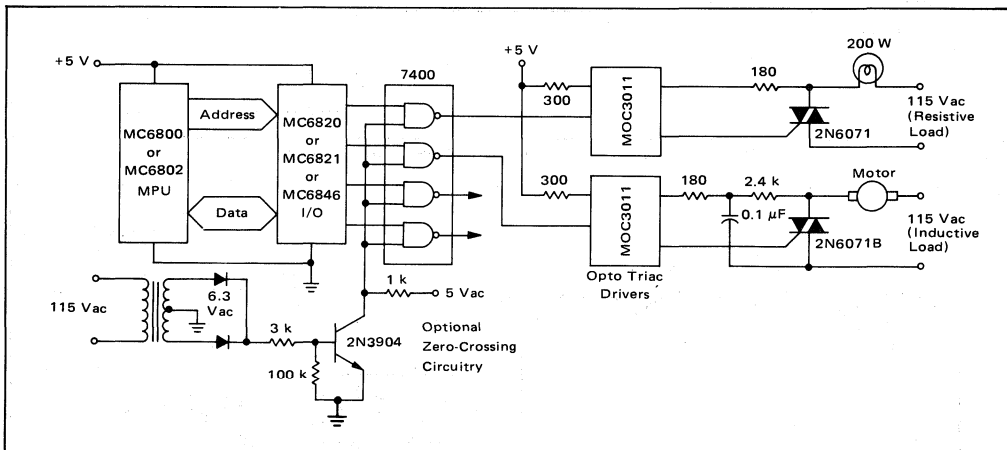

FIGURE 11 - Interfacing an M6800 Microcomputer System to 115 Vac Loads

Basic Concepts of Fiber Optics and Fiber Optic Communications

Prepared by
John Bliss, Applications Engineer
Joseph Slaughter, Product Engineer
Motorola Discrete & Special Technologies Group

INTRODUCTION

This note presents an introduction to the principles of fiber optics. Its purpose is to review some basic concepts from physics that relate to fiber optics and the application of semiconductor devices to the generation and detection of light transmitted by optical fibers. The discussion begins with a description of a fiber optic link and the inherent advantages of fiber optics over wired systems.

A FIBER OPTIC LINK

Webster gives as one definition of a link "something which binds together or connects." In fiber optics, a link is the assembly of hardware which connects a source of a signal with its ultimate destination. The items which comprise the assembly are shown in Figure 1. As the figure indicates, an input signal, for example, a serial digital bit stream, is used to modulate a light source, typically an LED (light emitting diode). A variety of modulation schemes can be used. These will be discussed later. Although the input signal is assumed to be a digital bit stream, it could just as well be an analog signal, perhaps video.

The modulated light must then be coupled into the optical fiber. This is a critical element of the system. Based on the coupling scheme used, the light coupled into the fiber could be two orders of magnitude less than the total power of the source.

Once the light has been coupled into the fiber, it is attenuated as it travels along the fiber. It is also subject to distortion. The degree of distortion limits the maximum data rate that can be transmitted through the fiber.

At the receive end of the fiber, the light is coupled into a detector element (like a photo diode). The coupling problem at this stage, although still of concern, is considerably less severe than at the source end. The detector signal is then reprocessed or decoded to reconstruct the original input signal.

A link like that described in Figure 1 can be fully transparent to the user. That is, everything from the input signal connector to the output signal connector can be prepackaged. Thus, the user need only be concerned with supplying a signal of some standard format and level (like NRZ T²L) and extracting a similar signal. Such a T²L in/T²L out system obviates the need for a designer to understand fiber optics. However, by analyzing the problems and concepts internal to the link, the user is better prepared to apply fiber optics technology to his system.

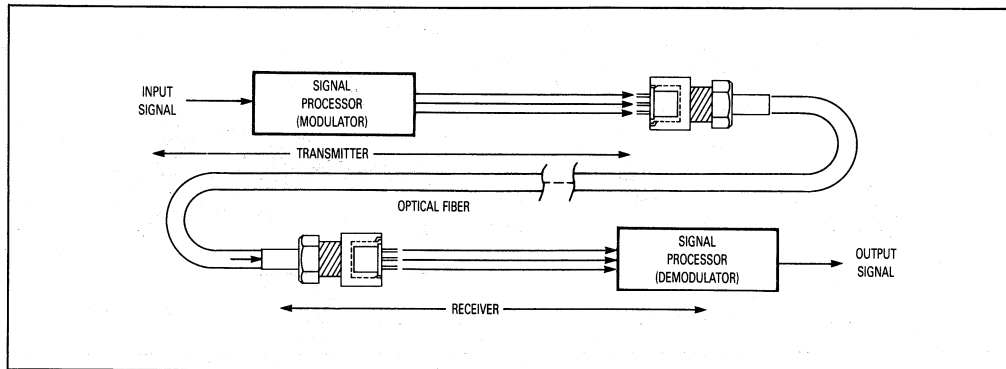

Figure 1. A Fiber Optic Link

ADVANTAGES OF FIBER OPTICS

There are both performance and cost advantages to be realized by using fiber optics over wire.

GREATER BANDWIDTH

The higher the carrier frequency in a communication system, the greater its potential signal bandwidth. Since fiber optics work with carrier frequencies on the order of 10^{13} – 10^{14} Hz as compared to radio frequencies of 10^6 – 10^8 Hz, signal bandwidths are theoretically 10^6 times greater.

SMALLER SIZE AND WEIGHT

A single fiber is capable of replacing a very large bundle of individual copper wire. For example, a typical telephone cable may contain over 1,000 pairs of copper wire and have a cross-sectional diameter of seven to ten centimeters. A single glass fiber cable capable of handling the same amount of signal might be only one-half centimeter in diameter. The actual fiber may be as small as $50\ \mu$ -meters. The additional size is the jacket and strength elements. The weight reduction in this example should be obvious.

LOWER ATTENUATION

Length for length, optical fiber exhibits less attenuation than does twisted wire or coaxial cable. Also, the attenuation of optical fibers, unlike that of wire, is not signal frequency dependent.

FREEDOM FROM EMI

Unlike wire, glass does not pick up nor generate electro-magnetic interference (EMI). Optical fibers do not require expensive shielding techniques to desensitize them to stray fields.

RUGGEDNESS

Glass is 20 times stronger than steel and since glass is relatively inert, corrosive environments are of less concern than with wired systems.

SAFETY

In many wired systems, the potential hazard of short circuits between wires or from wires to ground, requires special precautionary designs. The dielectric nature of optic fibers eliminates this requirement and the concern for hazardous sparks occurring during interconnects.

LOWER COST

Optical fiber costs are continuing to decline while the cost of wire is increasing. In many applications today, the total system cost for a fiber optic design is lower than for a comparable wired design. As time passes, more and more systems will be decidedly less expensive with optical fibers.

PHYSICS OF LIGHT

The performance of optical fibers can be fully analyzed by application of Maxwell's Equations for electromagnetic fields. However, these are necessarily complex and, fortunately, can be bypassed for most users by the application of geometric ray tracing and analysis. When considering LEDs and photo detectors, the particle theory of light is used. The change from ray to particle theory is fortunately a simple step.

Over the years, it has been demonstrated that light (in fact, all electromagnetic energy) travels at approximately 300,000 km/second in free space. It has also been demonstrated that in materials denser than free space, the speed of light is reduced. This reduction in the speed of light as it passes from free space into a denser material results in refraction of the light. Simply stated, the light

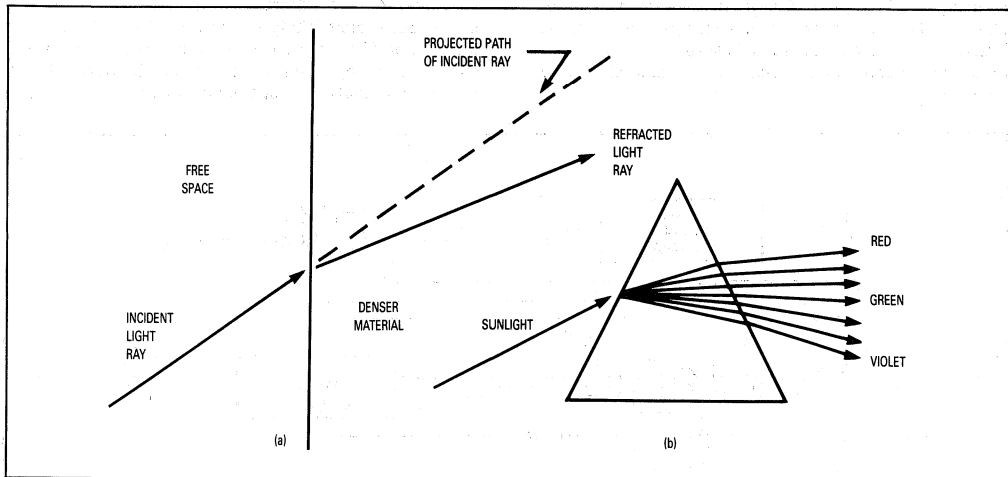

Figure 2. Refraction Of Light:

a. Light refraction at an interface; b. White light spectral separation by prismatic refraction.

ray is bent at the interface. This is shown in Figure 2a. In fact, the reduction of the speed of light is different for different wavelengths; and, therefore, the degree of bending is different for each wavelength. It is this variation in effect for different wavelengths that results in rainbows. Water droplets in the air act like small prisms (Figure 2b) to split white sunlight into the visible spectrum of colors.

The actual bend angle at an interface is predictable and depends on the **refractive index** of the dense material. The **refractive index**, usually given the symbol n , is the ratio of the speed of light in free space to its speed in the denser material:

$$n = \frac{\text{speed of light in free space}}{\text{speed of light in given material}} \quad (1)$$

Although n is also a function of wavelength, the variation in many applications is small enough to be ignored and a single value is given. Some typical values of n are given in Table 1:

Table 1.
Representative Indices of Refraction

Vacuum	1.0
Air	1.0003 (1.0)
Water	1.33
Fused Quartz	1.46
Glass	1.5
Diamond	2.0
Silicon	3.4
Gallium-Arsenide	3.6

It is interesting to consider what happens to a light ray as it meets the interface between two transmissive materials. Figure 3 shows two such materials of refractive indices n_1 and n_2 . A light ray is shown in material 1 and incident on the interface at point P. Snell's law states that:

$$n_1 \sin\theta_1 = n_2 \sin\theta_2 \quad (2)$$

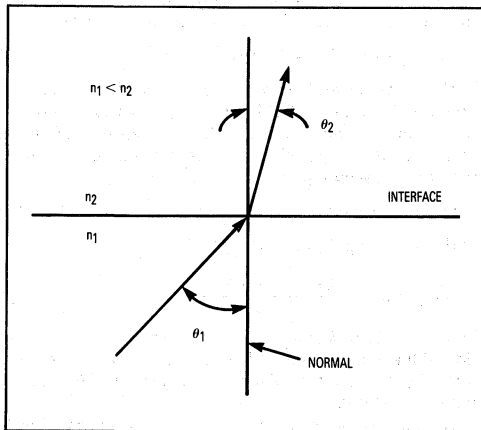

Figure 3. Refractive Model For Snell's Law

The angle of refraction, θ_2 , can be determined:

$$\sin\theta_2 = \frac{n_1}{n_2} \sin\theta_1 \quad (3)$$

If material 1 is air, n_1 has the value of 1; and since n_2 is greater than 1, θ_2 is seen to be less than θ_1 ; that is, in passing through the interface, the light ray is refracted (bent) toward the normal.

If material 1 is not air but still has an index of refraction less than material 2, the ray will still be bent toward the normal. Note that if n_2 is less than n_1 , θ_2 is greater than θ_1 , or the ray is refracted away from the normal.

Consider Figure 4 in which an incident ray is shown at an angle such that the refracted ray is along the interface or the angle of refraction is 90° . Note that $n_1 > n_2$. Using Snell's law:

$$\sin\theta_2 = \frac{n_1}{n_2} \sin\theta_1 \quad (4)$$

or, with θ_2 equal to 90° :

$$\sin\theta_1 = \frac{n_2}{n_1} = \sin\theta_c \quad (5)$$

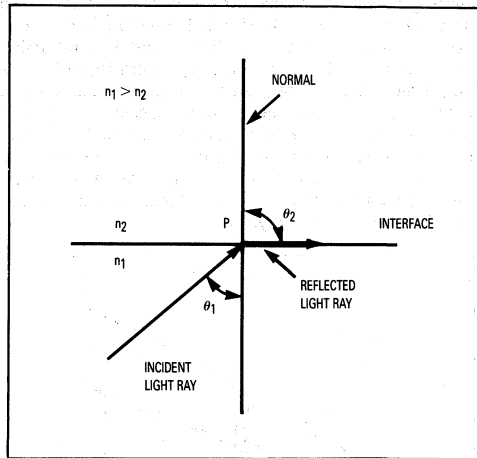

Figure 4. Critical Angle Reflection

The angle, θ_c , is known as the critical angle and defines the angle at which incident rays will not pass through the interface. For angles greater than θ_c , 100 percent of the light rays are reflected (as shown in Figure 5), and the angle of incidence equals the angle of reflection.

This characteristic of reflection for light incident at greater than the critical angle is a fundamental concept in fiber optics.

OPTICAL FIBERS

Figure 6 shows the typical construction of an optical fiber. The central portion, or core, is the actual propagating path for light. Although the core is occasionally constructed of plastic, it is more typically made of glass. The choice of material will be discussed later. Bonded to

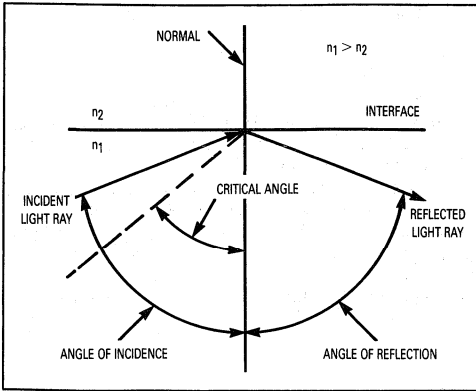

Figure 5. Light Incident At Greater Than Critical Angle

the core is a cladding layer — again, usually glass, although plastic cladding of glass core is not uncommon. The composition of glass can be tailored during processing to vary the index of refraction. For example, an all-glass, or silica-clad fiber, may have the compositions set so that the core material has an index of refraction of 1.5; and the clad has an index of refraction of 1.485. To protect the clad fiber, it is typically enclosed in some form of protective rubber or plastic jacket. This type of optical fiber is called a "step index multimode" fiber. Step index refers to the profile of the index of refraction across the fiber (as shown in Figure 7). The core has an essentially constant index n_1 . The classification "multimode" should be evident shortly.

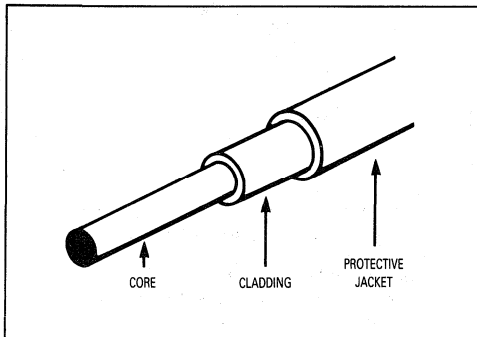

Figure 6. Single Fiber Construction

NUMERICAL APERTURE

Applying the concept of total internal reflection at the $n_1 n_2$ interface, we can now demonstrate the propagation of light along the fiber core and the constraint on light incident on the fiber end to ensure propagation. Figure 8 illustrates the analysis. As the figure shows, ray propagation results from the continuous reflection at the core/clad interface such that the ray bounces down the fiber length and ultimately exits at the far end. If the principle

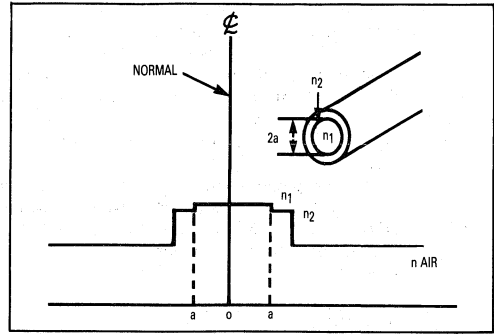

Figure 7. Index Profile For A Step Index Fiber

of total internal reflection is applied at point P, the critical angle value for θ_3 is found by Snell's law:

$$\theta_c = \theta_3 (\text{min}) = \sin^{-1} \frac{n_2}{n_1} \tag{6}$$

Now, since θ_2 is a complementary angle to θ_3 ,

$$\theta_2 (\text{max}) = \sin^{-1} \frac{(n_1^2 - n_2^2)^{1/2}}{n_1} \tag{7}$$

Again applying Snell's law at the entrance surface (recall $n_{\text{air}} = 1$),

$$\sin \theta_{in} (\text{max}) = n_1 \sin \theta_2 (\text{max}) \tag{8}$$

Combining (7) and (8),

$$\sin \theta_{in} (\text{max}) = (n_1^2 - n_2^2)^{1/2} \tag{9}$$

$\theta_{in} (\text{max})$ represents the largest angle with the normal to the fiber end for which total internal reflection will occur at the core/clad interface. Light rays entering the fiber end at angles greater than $\theta_{in} (\text{max})$ will pass through the interface at P and be lost. The value $\sin \theta_{in} (\text{max})$ is one of the fundamental parameters for an optical fiber. It defines the half-angle of the cone of acceptance for light to be propagated along the fiber and is called the "numerical aperture," usually abbreviated N.A.

$$\text{N.A.} = \sin \theta_{in} (\text{max}) = (n_1^2 - n_2^2)^{1/2} \tag{10}$$

There are several points to consider about N.A. and equation (10). Recall that in writing (8), we assumed that the material at the end of the fiber was air with an index of 1. If it were some other material, (8) would be written with n_3 representing the material:

$$n_3 \sin \theta_{in} (\text{max}) = n_1 \sin \theta_2 (\text{max}) \tag{11}$$

and, combining (7) and (11),

$$\sin \theta_{in} (\text{max}) = \frac{(n_1^2 - n_2^2)^{1/2}}{n_3} \text{N.A.} \tag{12}$$

That is, the N.A. would be reduced by the index of refraction of the end material. When fiber manufacturers specify N.A., it is usually given for an air interface unless otherwise stated.

The second point concerns the absoluteness of N.A. The analysis assumed that the light rays entered the fiber, and in propagating along it, they continually passed

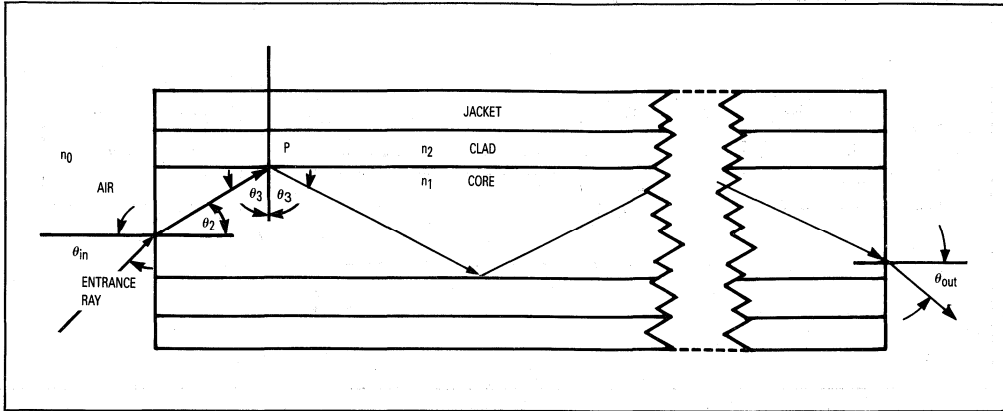

Figure 8. Ray Propagation In A Fiber

through the central axis of the fiber. Such rays are called "meridional" rays. It is entirely possible that some rays may enter the fiber at such an angle that in passing down the fiber, they never intercept the axis. Such rays are called "skew" rays. An example is shown in both side and end views in Figure 9.

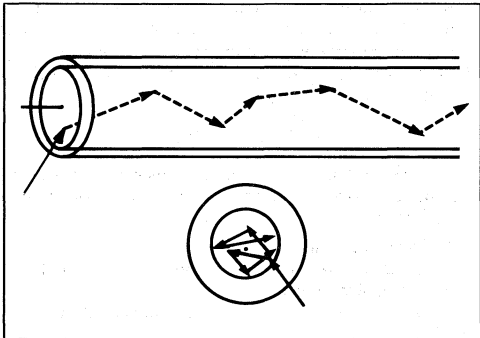

Figure 9. Skew Ray Path

Also, some rays may enter at angles very close to the critical angle. In bouncing along the fiber, their path length may be considerably longer than rays at shallower angles. Consequently, they are subject to a larger probability of absorption and may, therefore, never be recovered at the output end. However, for very short lengths of fiber, they may not be lost. These two effects, plus the presence of light in the cladding for short lengths, results in the N.A. not cutting off sharply according to equations (10) and (12) and of appearing larger for short lengths. It is advisable to define some criteria for specifying N.A. At Motorola, N.A. is taken as the acceptance angle for which the response is no greater than 10 dB down from the peak value. This is shown in Figure 10. Figure 11 shows a typical method of measuring a fiber's N.A. In the measurement, a sample to be measured (at least 1 meter to allow the attenuation of clad

and high order modes¹) is connected to a high N.A. radiometric sensor, such as a large-area photodiode. The power detected by the sensor is read on a radiometer power meter. The other end of the fiber is mounted on a rotatable fixture such that the axis of rotation is the end of the fiber. A collimated light source is directed at the

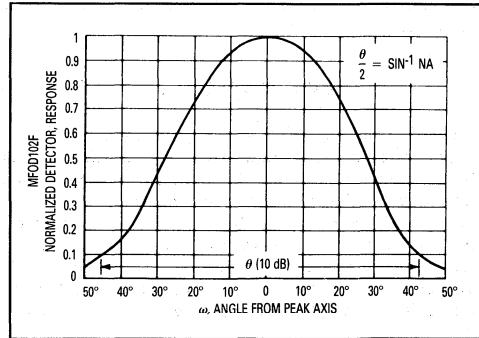

Figure 10. Graphical Definition Of Numerical Aperture

end of the fiber. This can be a laser or other source, such as an LED, at a sufficient distance to allow the rays entering the fiber to be paraxial. The fiber end is adjusted to find the peak response position. Ideally, this will be at zero degrees; but manufacturing variations could result in a peak slightly offset from zero. The received power level is noted at the peak. The fiber end is then rotated until the two points are found at which the received power is one-tenth the peak value. The sine of half the angle between these two points is the N.A.

The apparent N.A. of a fiber is a function of the N.A. of the source that is driving it. For example, Figures 12a and 12b are plots of N.A. versus length for the same fiber.

¹High order modes refers to steep angle rays.

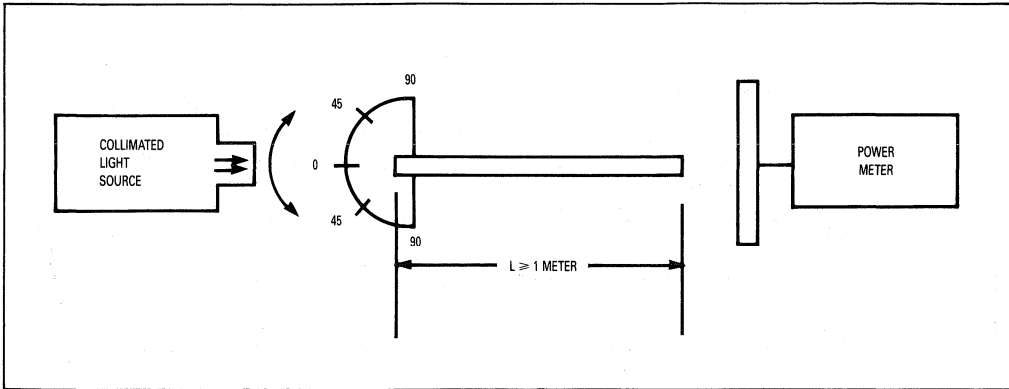

Figure 11. Measurement Of Fiber Numerical Aperture

In (12a) the source has a large N.A. (0.7), while in (12b) the source N.A. is 0.32. Note that in both cases, the N.A. at 100m is about 0.31; but at 1 meter, the apparent N.A. is 0.42 in (12a) but 0.315 in (12b). The high order modes entering the fiber from the 0.7 N.A. source take nearly the full 100 meters to be stripped out by attenuation. Thus, a valid measurement of a fiber's true N.A. requires a collimated, or very low, N.A. source or a very long-length sample.

in the wavelength they affect. For example, hydroxyl radicals (OH⁻) are strong absorbers of light at 900 nm. Therefore, if a fiber manufacturer wants to minimize losses at 900 nm, he will have to take exceptional care in his process to eliminate moisture (the source of OH⁻). Other impurities are also present in any manufacturing process. The degree to which they are controlled will determine the attenuation characteristic of a fiber. The cumulative effect of the various impurities results in plots of attenuation versus wavelength exhibiting peaks and valleys. Four examples of attenuation (given in dB/km) are shown in Figure 13.

FIBER ATTENUATION

Mention was made above of the "stripping" or attenuation of high order modes due to their longer path length. This suggests that the attenuation of power in a fiber is a function of length. This is indeed the case. A number of factors contribute to the attenuation: imperfections at the core/clad interface; flaws in the consistency of the core material; impurities in the composition. The surface imperfections and material flaws tend to affect all wavelengths. The impurities tend to be selective

FIBER TYPES

It was stated at the beginning of this section that fibers be made of glass or plastic. There are three varieties available today:

1. Plastic core and cladding;
2. Glass core with plastic cladding — often called 'PCS' (plastic-clad silica);
3. Glass core and cladding — silica-clad silica.

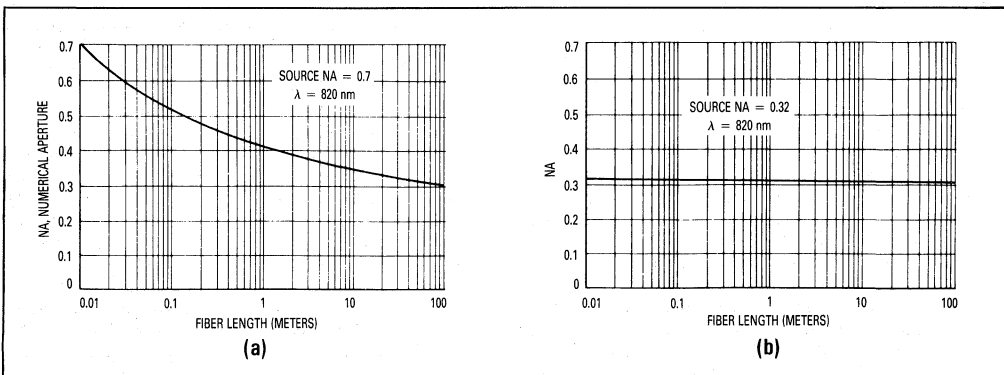

Figure 12. Fiber Numerical Aperture versus Length For Two Values Of Source N.A.

11

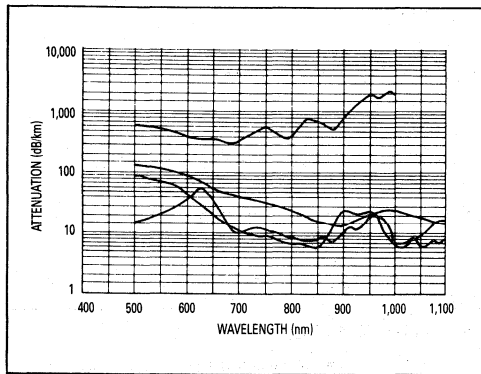

Figure 13. Fiber Attenuation versus Wavelength

All plastic fibers are extremely rugged and useful for systems where the cable may be subject to rough day-after-day treatment. They are particularly attractive for benchtop interconnects. The disadvantage is their high attenuation characteristic.

PCS cables offer the better attenuation characteristics of glass and are less affected by radiation than all-glass fibers.² They see considerable use in military-grade applications.

All glass fibers offer low attenuation performance and good concentricity, even for small-diameter cores. They are generally easy to terminate, relative to PCS. On the down side, they are usually the least rugged, mechanically, and more susceptible to increases in attenuation when exposed to radiation.

The choice of fiber for any given application will be a function of the specific system's requirements and trade-off options.

So far, the discussion has addressed single fibers. Fibers, particularly all-plastic, are frequently grouped in bundles. This is usually restricted to very low-frequency, short-distance applications. The entire bundle would interconnect a single light source and sensor or could be

²It should be noted that the soft clad material should be removed and replaced by a hard clad material for best fiber core-to-connector termination.

used in a fan-out at either end. Bundles are also available for interconnecting an array of sources with a matched array of detectors. This enables the interconnection of multiple discrete signal channels without the use of multiplex techniques. In this type of cable, the individual fibers are usually separated in individual jackets and, perhaps, each embedded in clusters of strength elements, like Kevlar. In one special case bundle, the fibers are arrayed in a ribbon configuration. This type cable is frequently seen in telephone systems using fiber optics.

In Figure 7, the refractive index profile was shown as constant over the core cross-section with a step reduction at the core/clad interface. The core diameter was also large enough that many modes (low and high order) are propagated along its path. In Figure 14, a section of this fiber is shown with three discrete modes shown propagating down the fiber. The lowest order mode is seen traveling parallel to the axis of the fiber. The middle order mode is seen to bounce several times at the interface. The total path length of this mode is certainly greater than that of the mode along the axis. The high order mode is seen to make many trips across the fiber, resulting in an extremely long path length.

The signal input to this fiber is seen as a step pulse of light. However, since all the light that enters the fiber at a fixed time does not arrive at the end at one time (the higher modes take longer to traverse their longer path), the net effect is to stretch or distort the pulse. This is characteristic of a multimode, step-index fiber and tends to limit the range of frequency for the data being propagated.

Figure 15 shows what this pulse stretching can do. An input pulse train is seen in (15a). At some distance (say 100 meters), the pulses (due to dispersion) are getting close to running together but are still distinguishable and recoverable. However, at some greater distance (say 200 meters), the dispersion has resulted in the pulses running together to the degree that they are indistinguishable. Obviously, this fiber would be unusable at 200 meters for this data rate. Consequently, fiber specifications usually give bandwidth in units of MHz-km — that is, a 200 MHz-km cable can send 200 MHz data up to 1.0 km or 100 MHz data up to 2.0 km etc.

To overcome the distortion due to path length differences, fiber manufacturers have developed graded index fiber. An example of multimode, graded-index fiber is shown in Figure 16.

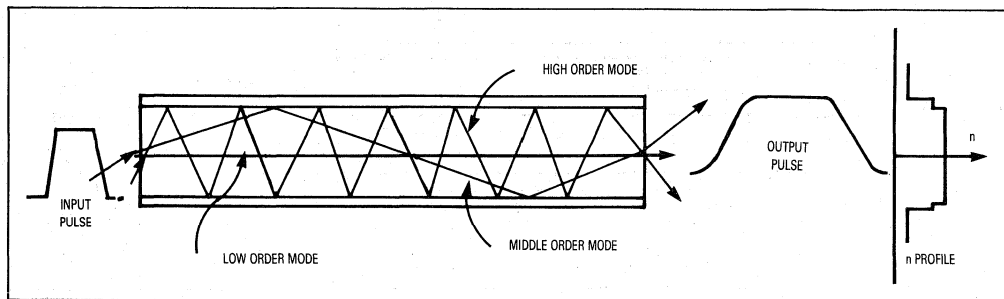

Figure 14. Propagation Along A Multimode Step Index Fiber

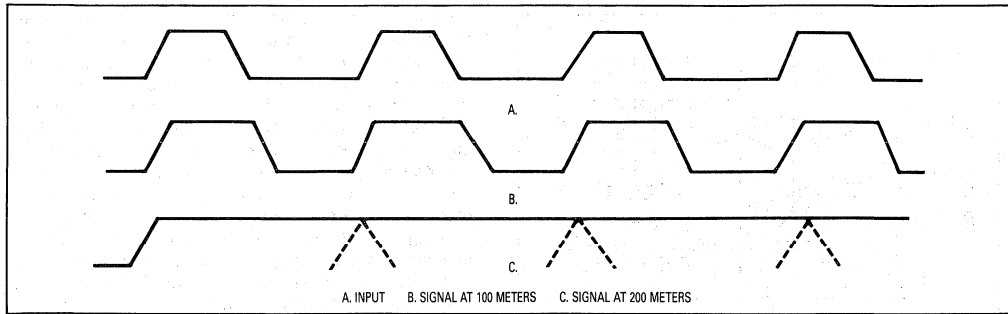

Figure 15. Loss Of Pulse Identity Due To Pulse Width Dispersion

In the fiber growth process, the profile of the index of refraction is tailored to follow the parabolic profile shown in the figure. This results in low order modes traveling through a constant density material. High order modes see lower density material as they get further away from the axis of the core. Thus, the velocity of propagation increases away from the center. The result is that all modes, although they may travel different distances, tend to cover the length of the fiber in the same amount of time. This yields a fiber with higher bandwidth capability than multimode stepped index.

One more fiber type is also available. This is the single mode, step-index fiber shown in Figure 17. In this fiber, the core is extremely small (on the order of just a few micrometers). This type accepts only the lowest order mode and suffers no modal dispersion. It is an expensive fiber and requires a very high-power, highly-directional source like a laser diode. Consequently, applications for this type of fiber are the very high data rate, long-distance systems.

As a final statement on fiber properties, it is interesting to compare optical fiber with coax cable. Figure 18 shows the loss versus frequency characteristics for a low-loss fiber compared with the characteristics of several common coax cables. Note that the attenuation of optical fiber is independent of frequency (up to the point where modal dispersion comes into play).

ACTIVE COMPONENTS FOR FIBER OPTICS

Propagation through fiber optics is in the form of light or, more specifically, electromagnetic radiation in the spectral range of near-infrared or visible light. Since the signal levels to be dealt with are generally electrical in nature (like serial digital logic at standard T²L levels), it is necessary to convert the source signal into light at the transmitter end and from light back to T²L at the receive end. There are several components which can accomplish these conversions. This discussion will concentrate on light emitting diodes (LEDs) as sources and PIN photo diodes and Integrated Detector Preamplifiers (IDPs) as sensors.

LIGHT EMITTING DIODES

Most people are familiar with LEDs in calculator displays. Just as they are optimized geometrically and visually for the function of displaying characters, some LEDs are specifically designed and processed to satisfy the requirements of generating light, or near infrared for coupling into fibers. There are several criteria of importance for LEDs used with fibers:

1. Output power;
2. Wavelength;
3. Speed;
4. Emission pattern.

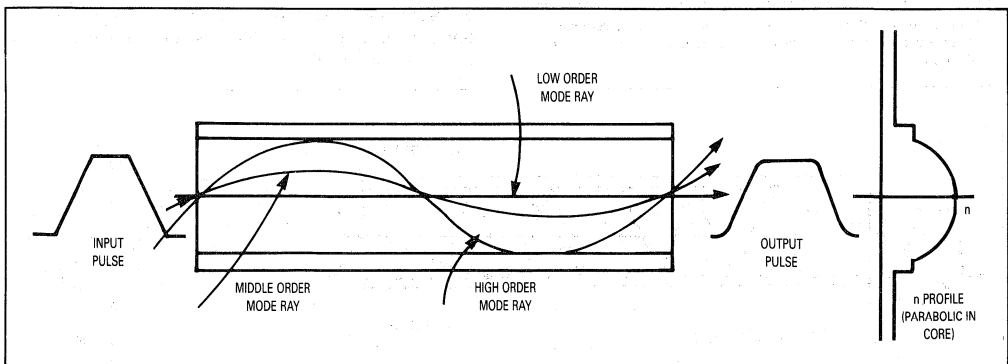

Figure 16. Propagation Along A Multimode Graded Index Fiber

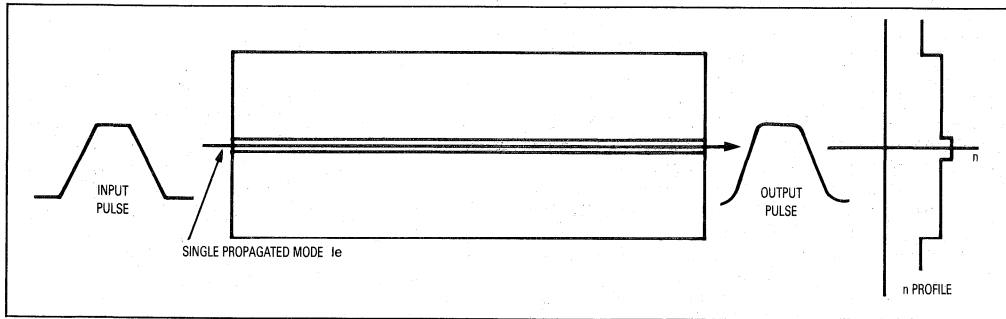

Figure 17. Propagation Along A Single Mode Step Index Fiber

OUTPUT POWER

Manufacturers are continually striving to increase the output power or efficiency of LEDs. The more efficient an LED, the lower its drive requirements, or the greater the losses that can be accommodated elsewhere in the system. However, total power emitted by an LED is not the whole picture (see **Emission Pattern**).

WAVELENGTH

As shown earlier, optical fibers exhibit an attenuation characteristic that varies with wavelength. Figure 19 is a repeat of one of the sample curves from Figure 13. If this fiber were to be used in a system, the desired wavelength of operation would be about 875 nm where the attenuation is down to about 7.0 dB/km. The most undesirable wavelength for use in this fiber's range is 630 nm where the loss is about 600 dB/km. Therefore, all other considerations being satisfied, an LED with a characteristic emission wavelength of 875 nm would be used.

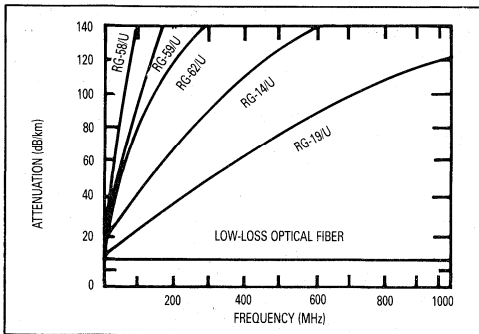

Figure 18. Comparative Attenuation versus Frequency For Optical Fiber and Coax Cable

SPEED

LEDs exhibit finite turn-on and turn-off times. A device with a response of 100 ns would never work in a 20 MHz system. (In general, the 3.0 dB bandwidth is equal to 0.35 divided by the risetime.) In a symmetrical RTZ system (see data encoding later in this paper), the pulse width for a single bit would be 25 ns. A 100 ns LED would hardly have begun to turn on when it would be required to turn off. There is often a trade-off between speed and power,

so it would not be advisable to select the fastest diode available but rather the fastest required to do the job, with some margin designed in.

EMISSION PATTERN

In typical data communications systems that light from the LED is coupled into a fiber with a core diameter of 50 to 100 μm . If the emission pattern of a particular LED is a collimated beam of 50 μm or less diameter, it might be possible to couple nearly all the power into the fiber. Thus, a 100 μW LED with such an emission pattern might be a better choice than a 5.0 mW LED with a lambertian³ pattern.

LIGHT GENERATION

Light is emitted from an LED as a result of the recombining of electrons and holes. Electrically, an LED is just a P-N junction. Under forward bias, minority carriers are injected across the junction. Once across, they recombine with majority carriers and give up their energy in the process. The energy given up is approximately equal to the energy gap for the material. The same injection/recombination process occurs in any P-N junction; but in certain materials, the nature of the process is typically

³Lambertian: The spatial pattern of reflected light from a sheet of paper, e.g. The intensity of light in any direction from a plane lambertian surface is equal to the intensity in the direction of the normal to the surface times the cosine of the angle between the direction and the normal.

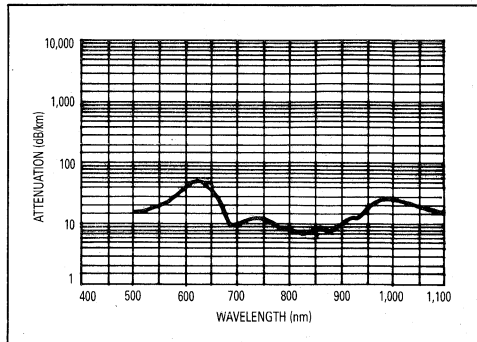

Figure 19. Attenuation versus Wavelength For A Sample Fiber

radiative — that is, a photon of light is produced. In other materials (silicon and germanium, for example), the process is primarily non-radiative and no photons are generated.

Light emitting materials do have a distribution of non-radiative sites — usually crystal lattice defects, impurities, etc. Minimizing these is the challenge to the manufacturer in his attempt to produce more efficient devices. It is also possible for non-radiative sites to develop over time and, thus, reduce efficiency. This is what gives LEDs finite lifetimes, although 10^5 to 10^6 -hour lifetimes are essentially infinite compared with some other components of many systems.

The simplest LED structures are homojunction, epitaxially-grown devices and single-diffused devices. These structures are shown in Figure 20.

The epitaxially-grown LED is generally constructed of silicon-doped gallium-arsenide. A melt of elemental gallium containing arsenic and silicon dopant is brought in contact at high temperature with the surface of an n-type gallium-arsenide wafer. At the initial growth temperature, the silicon atoms in the dopant replace some of the gallium atoms in the crystal lattice. In so doing, they contribute an excess electron to the bond. This results in the grown layer being n-type. During the growth, the temperature is systematically reduced. At a certain critical temperature, the silicon atoms begin to replace some of the arsenic atoms in the crystal. This removes an electron from the bond, resulting in the formation of a p-type layer. As a finished diode, the entire surface, as well as the four sides, radiate light. The characteristic wavelength of this type of device is 940 nm, and it typically radiates a total power of 3.0 mW at 100 mA forward current. It is relatively slow with turn-on and turn-off times on the order of 150 ns. The non-directionality of its emission makes it a poor choice as a light source for use with optical fibers.

The planar diffused LED is formed by controlled diffusions of zinc into a tellurium-doped n-gallium-arsenide wafer. A finished diode has a typical power output of 500 μ W at a wavelength of 900 nm. Turn-on and turn-off times are usually around 15–20 ns. The emission pattern is lambertian, similar to the grown junction LED above.

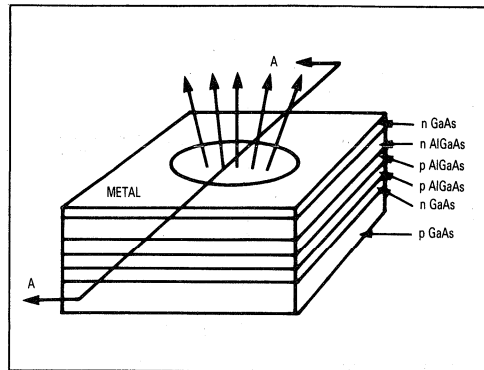

Figure 21. Planar Heterojunction LED

Both of the above structures, although they can be used in fiber optics, are not optimized for the purpose of coupling into small fibers. Several variations of LED structures are currently used to improve the efficiency of light coupling into fibers. The two basic structures for fiber optic LEDs are surface emitting and edge emitting. Surface-emitting devices are further broken down to planar and etched-well devices. The material used for these devices could be gallium-arsenide or any material which exhibits efficient photon-generating ability. The most common material in use today is the ternary crystal aluminum-gallium-arsenide. It is used extensively because it results in very efficient devices and has a characteristic wavelength around 850 nm⁴ at which many fibers give lowest attenuation. (Many fibers are even better around 1300 nm, but the materials technology for LEDs at this wavelength — InGaAsP — is still on the front end of the learning curve; and devices are very expensive.)

⁴This is adjustable by varying the mix of aluminum in the aluminum-gallium-arsenide crystal.

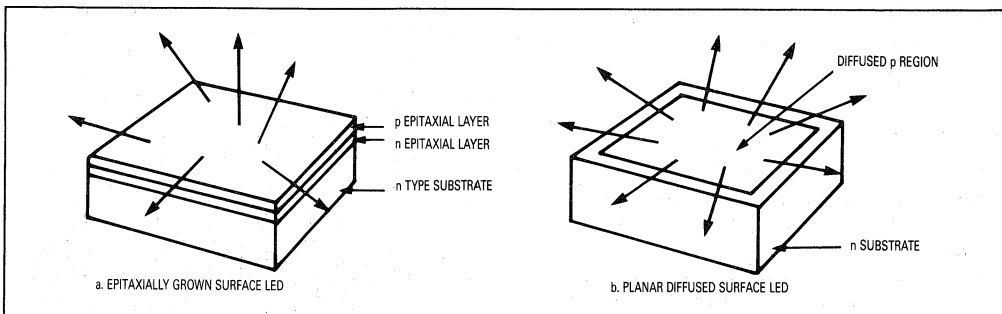

Figure 20. Simple LED Structures

- a. Epitaxially Grown
- b. Planar Diffused

PLANAR FIBER OPTIC LED

The planar heterojunction LED is somewhat similar to the grown junction LED of Figure 20a. Both utilize the liquid-phase epitaxial process to fabricate the device. The LED shown in Figure 21 is a heterojunction aluminum-gallium-arsenide structure. The geometry is designed so that the device current is concentrated in a very small area of the active layer. This accomplishes several things: (1) the increase in current density makes for a brilliant light spot; (2) the small emitting area is well suited to coupling into small core fibers; and (3) the small effective area has a low capacitance and, thus, higher speed.

In Figure 21, the device appears to be nothing more than a multilayer version of the device in Figure 20a with a top metal layer containing a small opening. However, as the section view of AA shows in Figure 22, the internal construction provides some interesting features. To achieve concentration of the light emission in a small area, a method must be incorporated to confine the current to the desired area. Since the individual layers are grown across the entire surface of the wafer, a separate process must be used to confine the current. First an n-type tellurium-doped layer is grown on a zinc-doped p-type substrate. Before any additional layers are grown, a hole is etched through the n-layer and just into the substrate. The diameter of the hole defines the ultimate light-emitting area. Next, a p-type layer of AlGaAs is grown. This layer is doped such that its resistivity is quite high; this impedes carrier flow in a horizontal direction, but vertical flow is not impeded since the layer is so thin. This ensures that current flow from the substrate will be confined to the area of the etched hole. The next layer to be grown is the p-type active layer. The aluminum-gallium mix of this layer gives it an energy gap corresponding to 850 nm wavelength photons. The actual P-N junction is then formed by growth of n-type tellurium-doped aluminum-gallium-arsenide. The doping and aluminum-gallium mix of this layer is set to give it a larger energy gap than the p-layer just below it. This makes it essentially transparent to the 850 nm photons generated below. A final cap layer of gallium-arsenide is grown to enable ohmic contact by the top metal. The end result is an 850 nm planar LED of small emission area. The radiation pattern is still lambertian, however.

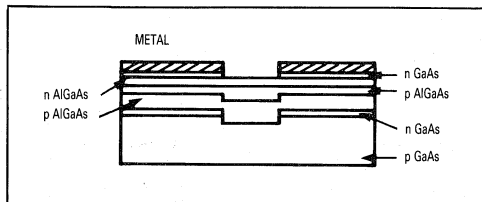

Figure 22. Section AA Of Planar Heterojunction LED

If a fiber with a core equal in area to the emission area is placed right down on the surface, it might seem that all the emitted light would be collected by the fiber; but since the emission pattern is lambertian, high order mode rays will not be launched into the fiber.

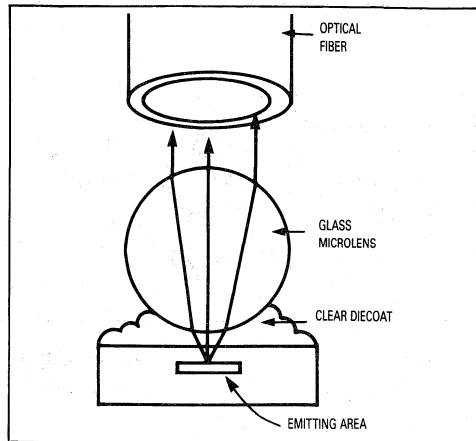

Figure 23. Increasing Light Coupling With A Microsphere

There is a way to increase the amount of light coupled. If a spherical lens is placed over the emitting area, the collimating effect will convert high order modes to low order modes (see Figure 23).

ETCHED-WELL SURFACE LED

For data rates used in telecommunications (100 MHz), the planar LED becomes impractical. These higher data rates usually call for fibers with cores on the order of 50–62 μm . If a planar LED is used, the broad emission pattern of several hundred micro-meters will only allow a few percent of the power to be launched into the small fiber. Of course, the emission area of the planar device could be reduced; but this can lead to reliability problems. The increase in current density will cause a large temperature rise in the vicinity of the junction, and the thermal path from the junction to the die-attach header (through the confining layer and substrate) is not good enough to help draw the heat away from the junction. Continuous operation at higher temperature would soon increase the non-radiative sites in the LED and the efficiency would drop rapidly. If the chip is mounted upside down, the hot spot would be closer to the die-attach surface; but the light would have to pass through the thick substrate. The photon absorption in the substrate would reduce the output power significantly. A solution to this problem was developed by Burris and Dawson, of Bell Labs. The etched-well, or "Burrus" diode, is shown in Figure 24.

The thick n-type substrate is the starting wafer. Successive layers of aluminum-gallium-arsenide are grown epitaxially on the substrate. The layer functions (confinement, active, window) are essentially the same as in the planar structure. After the final p-type layer (contact) is grown, it is covered with a layer of SiO_2 . Small openings are then cut in the SiO_2 to define the active emitting area. Metal is then evaporated over the wafer and contacts the p-layer through the small openings. The final processing consists of etching through the substrate. The etched

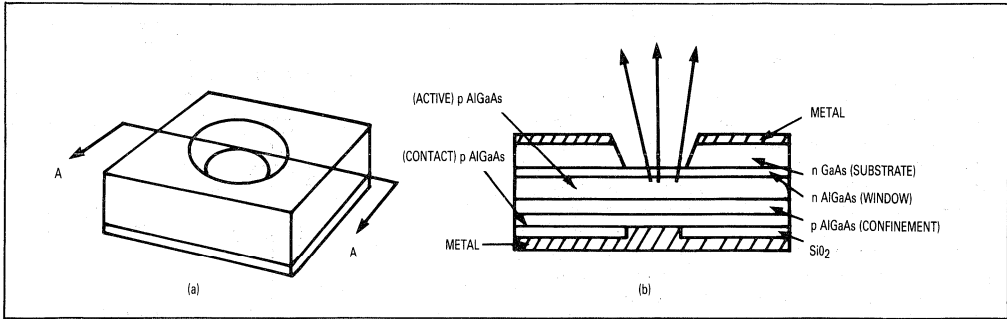

Figure 24. Burrus, Or Etched Well, LED:
(a) Device (b) Crosssection at AA

wells are aligned over the active areas defined by the SiO₂ openings on the underside of the wafer and remove the heavily-photon-absorptive substrate down to the window layer. As an indication of the delicacy of this operation, it requires double-sided alignment on a wafer about 0.1 mm thick with a final thickness in the opening of about 0.025 mm.

The radiation pattern from the Burrus diode is still lambertian. However, it has a remarkably-small emitting area and enables coupling into very small fibers (down to 50 μm). The close proximity of the hot spot (0.005 mm) to the heatsink at the die attach makes it a reliable structure.

Several methods can be used for launching the emitted power into a fiber. These are shown in Figure 25.

The Burrus structure is superior to the planar for coupling to small fibers (<100 μm) but considerably more expensive due to its delicate structure.

EDGE-EMITTING LED

The surface structures discussed above are lambertian sources. A variation of the heterojunction family that

emits a more directional pattern is the edge-emitting diode. This is shown in Figure 26. The layer structure is similar to the planar and Burrus diodes, but the emitting area is a stripe rather than a confined circular area. The emitted light is taken from the edge of the active stripe and forms an elliptical beam. The edge-emitting diode is quite similar to the diode lasers used for fiber optics. Although the edge emitter provides a more efficient source for coupling into small fibers, its structure calls for significant differences in packaging from the planar or Burrus.

PHOTO DETECTORS

PIN PHOTODIODES

Just as a P-N junction can be used to generate light, it can also be used to detect light. If a P-N junction is reverse-biased and under dark conditions, very little current flows through it. However, when light shines on the device, photon energy is absorbed and hole-electron pairs are created. If the carriers are created in or near the depletion region at the junction, they are swept across the junction by the electric field. This movement of charge

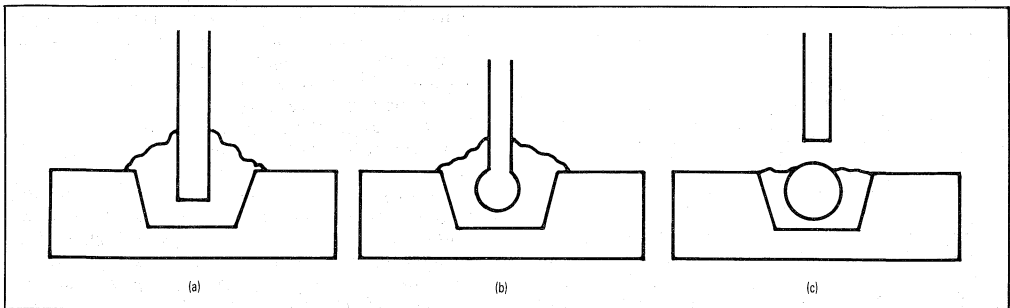

Figure 25. Fiber Coupling To A Burrus Diode:

- (a) Standard Fiber Epoxied in Well.
- (b) Fiber with Balled End Epoxied in Well.
- (c) Microlens Epoxied in Well.

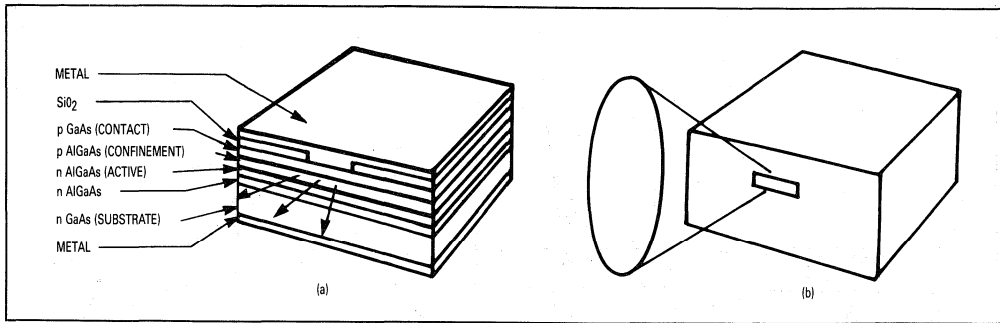

Figure 26. Edge Emitting LED:
 (a) Structure (b) Beam Pattern

carriers across the junction causes a current flow in the circuitry external to the diode. The magnitude of this current is proportional to the light power absorbed by the diode and the wavelength. A typical photodiode structure is shown in Figure 27, and the IV characteristic and spectral sensitivity are given in Figure 28.

In Figure 28a, it is seen that under reverse-bias conditions, the current flow is a noticeable function of light power density on the device. Note that in the forward-bias mode, the device eventually acts like an ordinary forward-biased diode with an exponential IV characteristic.

Although this type of P-N photodiode could be used as a fiber optic detector, it exhibits three undesirable features. The noise performance is generally not good enough to allow its use in sensitive systems; it is usually not fast enough for high-speed data applications; and due to the depletion width, it is not sensitive enough. For example, consider Figure 29. The depletion is indicated by the plot of electric field. In a typical device, the p-anode is very heavily doped; and the bulk of the depletion region is on the n-cathode side of the junction. As light shines on the device, it will penetrate through the p-region toward the junction. If all the photon absorption

takes place in the depletion region, the generated holes and electrons will be accelerated by the field and will be quickly converted to circuit current. However, hole-electron pair generation occurs from the surface to the back side of the device. Although most of it occurs within the depletion region, enough does occur outside this region to cause a problem in high-speed applications. This problem is illustrated in Figure 30. A step pulse of light is applied to a photodiode. Because of distributed capacitance and bulk resistance, an exponential response by the diode is expected. The photocurrent waveform shows this as a ramp at turn-on. However, there is a distinct tail that occurs starting at point "a." The initial ramp up to "a" is essentially the response within the depletion region. Carriers that are regenerated outside the depletion region are not subject to acceleration by the high electric field. They tend to move through the bulk by the process of diffusion, a much slower travel. Eventually, the carriers reach the depletion region and are sped up. The effect can be eliminated, or at least substantially reduced by using a PIN structure. This is shown in Figure 31, and the electric field distribution is shown in Figure 32. Almost the entire electric field is across the

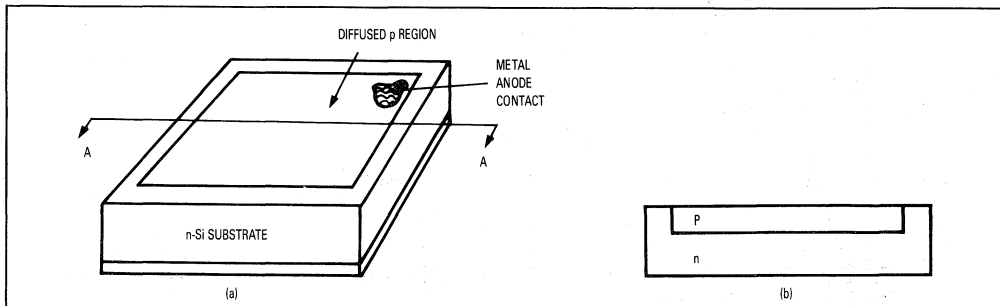

Figure 27. PN Photodiode:
 (a) Device (b) Section View at AA

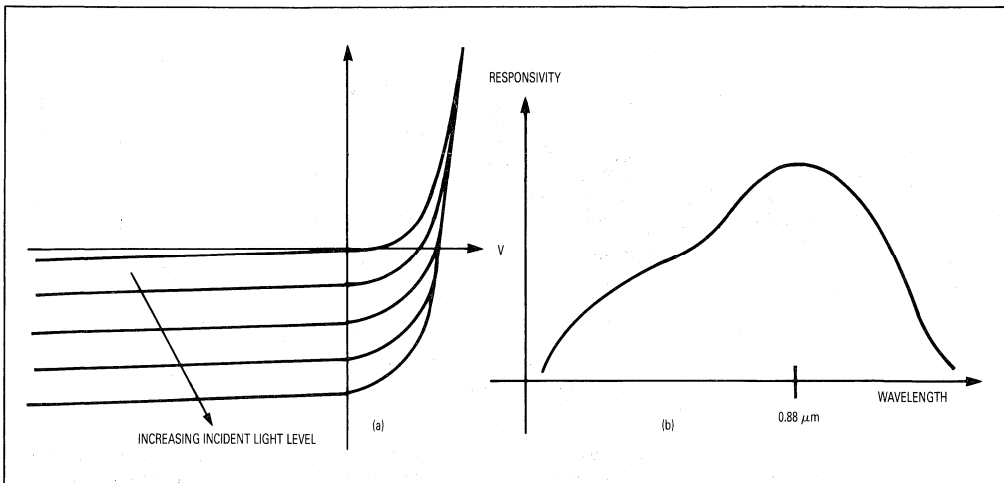

Figure 28. Characteristics Of A PN Photodiode:

(a) I-V Family (b) Spectral Sensitivity

intrinsic (I) region and very few photons are absorbed in the p- and n-region. The photocurrent response in such a structure is essentially free of the tailing effect seen in Figure 30.

In addition to the response time improvements, the high resistivity I-region gives the PIN diode lower noise performance.

The critical parameters for a PIN diode in a fiber optic application are:

1. Responsivity;
2. Dark current;
3. Response speed;
4. Spectral response.

Responsivity is usually given in amps/watt at a particular wavelength. It is a measure of the diode output current for a given power launched into the diode. In a system, the designer must then be able to calculate the

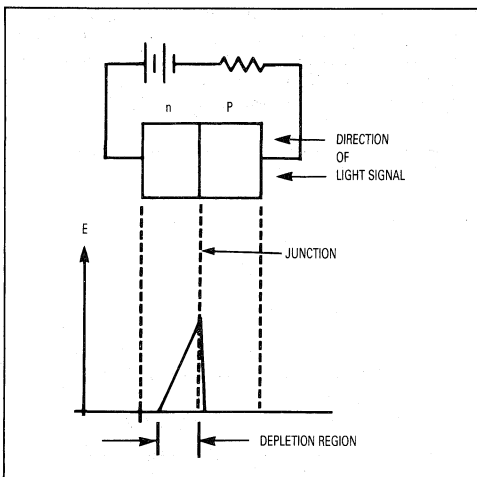

Figure 29. Electric Field In A Reverse-Biased PN Photodiode

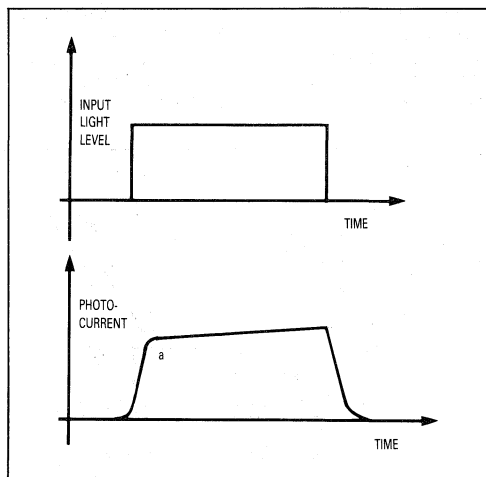

Figure 30. Pulse Response Of A Photodiode

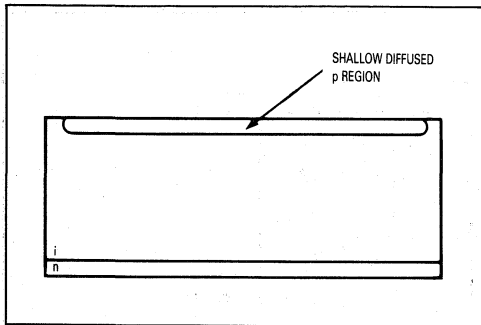

Figure 31. PIN Diode Structure

power level coupled from the system to the diode (see AN-804, listed in Bibliography).

Dark Current is the thermally-generated reverse leakage current in the diode. In conjunction with the signal current calculated from the responsivity and incident power, it gives the designer the on-off ratio to be expected in a system.

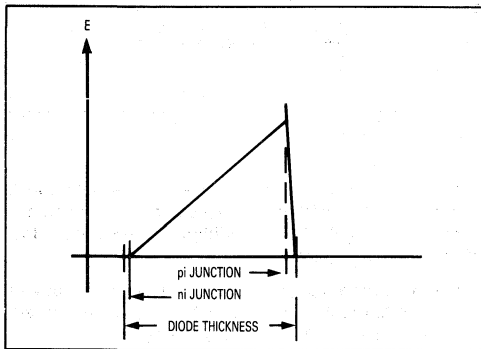

Figure 33. Relative Spectral Response
MFOD1100 PIN Photodiode

Response Speed determines the maximum data rate capability of the diode; and in conjunction with the response of other elements of the system, it sets the maximum system data rate.⁵

Spectral Response determines the range, or system length, that can be achieved relative to the wavelength at which responsivity is characterized. For example, consider Figure 33. The responsivity of the MFOD1100 is given as 0.3 A/W at 850 nm. As the curve indicates, the response at 850 nm is 96 percent of the peak response. If the diode is to be used in a system with an LED operating at 900 nm, the response (or system length) would be:

$$R(900) = \frac{0.78}{0.96} R(850) = 0.81R(850) = 0.24 \text{ A/W} \quad (13)$$

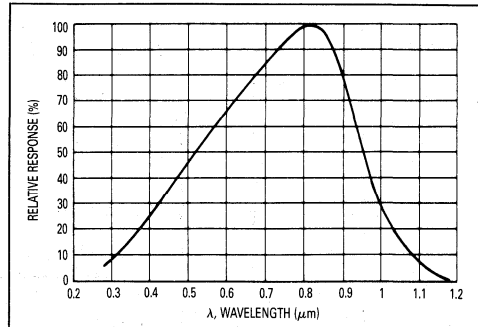

Figure 32. Electric Field Distribution
In A PIN Photodiode

INTEGRATED DETECTOR PREAMPLIFIERS

The PIN photodiode mentioned above is a high output impedance current source. The signal levels are usually on the order of tens of nanoamps to tens of microamps. The signal requires amplification to provide data at a usable level like T²L. In noisy environments, the noise-insensitive benefits of fiber optics can all be lost at the receiver connection between diode and amplifier. Proper shielding can prevent this. An alternative solution is to integrate the follow-up amplifier into the same package as the photo diode. This device is called an integrated detector preamplifier (IDP). An example of this is given in Figure 34.

Incorporating an intrinsic layer into the monolithic structure is not practical with present technology, so a P-N junction photodiode is used. The first two transistors form a transimpedance amplifier. A third stage emitter follower is used to provide resistive negative feedback. The amplifier gives a low impedance voltage output which is then fed to a phase splitter. The two outputs are coupled through emitter followers.

The MFOD2404 IDP has a responsivity greater than 23 mV/μW at 850 nm. The response rise and fall times are 50 ns maximum, and the input light power can go as high as 30 μW before noticeable pulse distortion occurs. Both outputs offer a typical impedance of 200 Ω.

The IDP can be used directly with a voltage comparator or, for more sophisticated systems, could be used to drive any normal voltage amplifier. Direct drive of a comparator is shown in Figure 35.

A FIBER OPTICS COMMUNICATION SYSTEM

Now that the basic concepts and advantages of fiber optics and the active components used with them have been discussed, it is of interest to go through the design of a system. The system will be a simple point-to-point

⁵Device capacitance also impacts this. See "Designer's Guide to Fiber-Optic Data Links" listed in Bibliography.

⁶In a simplex system, a single transmitter is connected to a single receiver by a single fiber. In a half duplex system, a single fiber provides a bidirectional alternate signal flow between a transmitter/receiver pair at each end. A full duplex system would consist of a transmitter and receiver at each end and a pair of fibers connecting them.

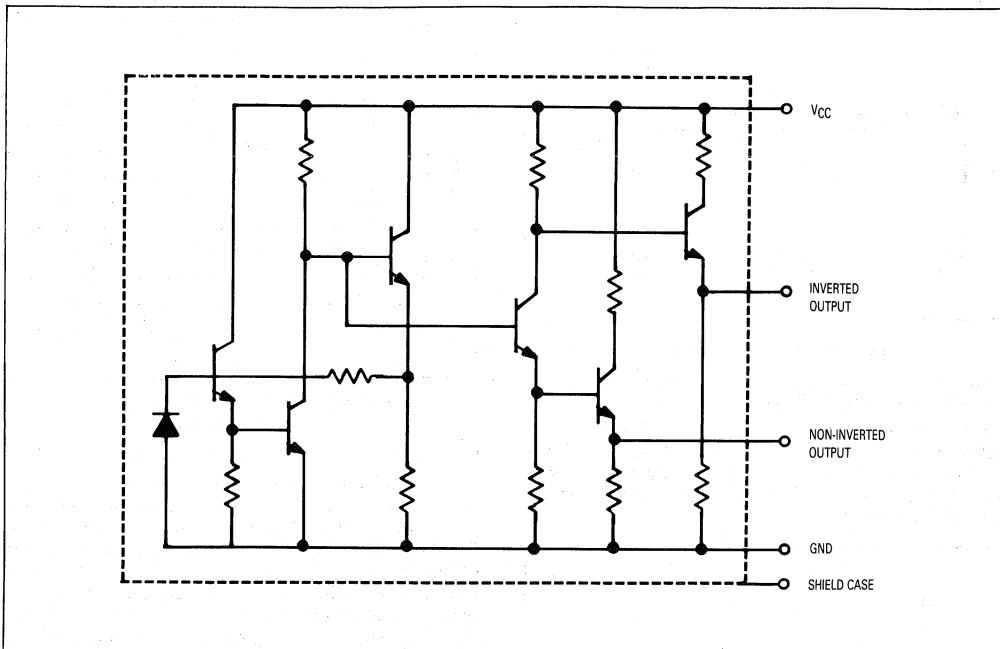

Figure 34. Integrated Detector Preamplifier

application operating in the simplex⁶ mode. The system will be analyzed for three aspects:

1. Loss budget;
2. Rise time budget;
3. Data encoding format.

LOSS BUDGET

If no in-line repeaters are used, every element of the system between the LED and the detector introduces some loss into the system. By identifying and quantifying each loss, the designer can calculate the required transmitter power to ensure a given signal power at the receiver, or conversely, what signal power will be received for a given transmitter power. The process is referred to as calculating the system loss budget.

This sample system will be based on the following individual characteristics:

Transmitter: MFOE1100 series, characteristics as in Figure 36.

Fiber: Silica-clad silica fiber with a core diameter of 100 μm , step index multimode; 7.0 dB/km attenuation at 850 nm; N.A. of 0.29 and a 3.0 dB bandwidth of 100 MHz-km.

Receiver: MFOD2404, characteristics as in Figure 37.

The system will link a transmitter and receiver over a distance of 1000 meters and will use a single section of fiber (no splices). Some additional interconnect loss information is required.⁷

1. Whenever a signal is passed from an element with an N.A. greater than the N.A. of the receiving element, the loss incurred is given by:

$$\text{N.A. Loss} = 20 \log (\text{NA1/NA2}) \quad (14)$$
 where; NA1 is the exit numerical aperture of the signal source; where NA2 is the acceptance N.A. of the element receiving the signal.
2. Whenever a signal is passed from an element with a cross-sectional area greater than the area of the receiving element, the loss incurred is given by:

$$\text{Area Loss} = 20 \log (\text{Diameter 1/Diameter 2}) \quad (15)$$
 where: Diameter 1 is the diameter of the signal source (assumes a circular fiber port); where: Diameter 2 is the diameter of the element receiving the signal.
3. If there is any space between the sending and receiving elements, a loss is incurred. For example: an LED with an exit N.A. of 0.3 will result in a gap loss of 0.7 dB if it couples into a fiber over a gap of 0.1 mm.
4. If the source and receiving elements have their axes offset, there is an additional loss. This loss is also

⁷For a detailed discussion of all these loss mechanisms, see Reference

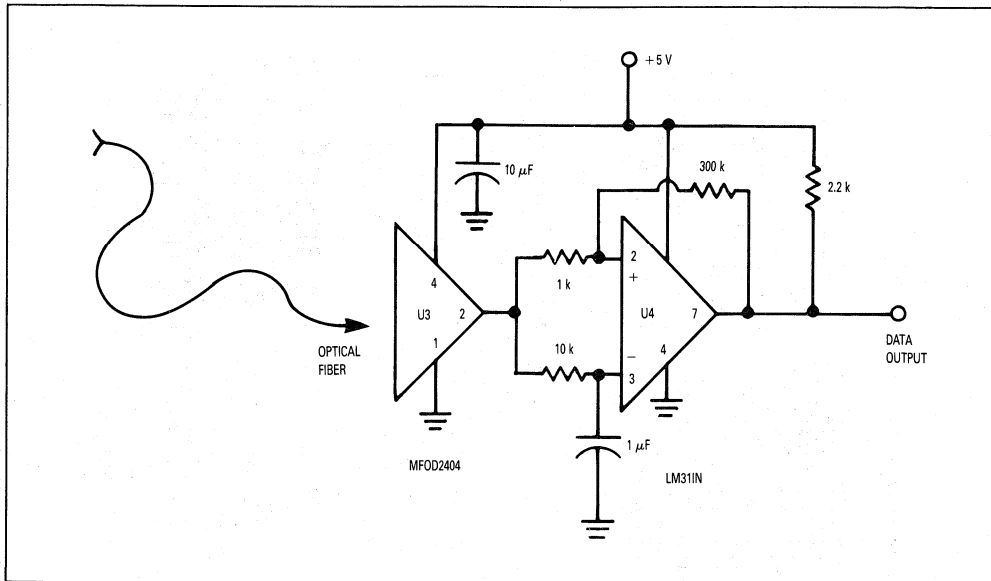

Figure 35. Simple F/O Data Receiver Using IDP And A Voltage Comparator

- dependent on the separation gap. For an LED with an exit N.A. of 0.3, a gap with its receiving fiber of 0.1 mm, and an axial misalignment of 0.035 mm, there will be a combined loss of 1.0 dB.
5. If the end surfaces of the two elements are not parallel, an additional loss can be incurred. If the non-parallelism is held below 2–3 degrees, this loss is minimal and can generally be ignored.
 6. As light passes through any interface, some of it is reflected. This loss, called Fresnel loss, is a function of the indices of refraction of the materials involved. For the devices in this example, this loss is typically 0.2 dB/interface.

The system loss budget is now ready to be calculated. Figure 38 shows the system configuration. Table 2 presents the individual loss contribution of each element in the link.

Table 2. Fiber Optic Link Loss Budget

Fiber Attenuation (1.0 km)	7.0 dB
Fiber Exit Fresnel Loss	0.2 dB
Receiver Gap and Misalignment Loss	1.0 dB
Detector Fresnel Loss	0.2 dB
Fiber to Detector N.A. Loss	0
Fiber to Detector Area Loss	0
Total Path Loss	8.4 dB

In this system, the LED is operated at 100 mA. Figure 36 shows that at this current the instantaneous power launched into a 100 µm fiber is greater than 60 µW. This

assumes that the junction temperature is maintained at 25°C. The power launched is then converted to a reference level relative to 1.0 mW:

$$P_L = 10 \log (0.06 \text{ mW}/1.0 \text{ mW}) \quad (16)$$

$$P_L = -12.2 \text{ dBm} \quad (17)$$

The power received by the MFOD2404 is then calculated:

$$P_R = P_L - \text{loss} \quad (18)$$

$$= -12.2 - 8.4 \quad (19)$$

$$= -20.6 \text{ dBm}$$

This reference level is now converted back to absolute power:

$$P_R = 10^{(-20.6 / 10)} \text{ mW} = 0.0087 \text{ mW} \quad (20)$$

Based on the typical responsivity of the MFOD2404 from Figure 37, the expected output signal will be:

$$V_O = (35 \text{ mV}/\mu\text{W})(8.7 \mu\text{W}) = 304 \text{ mV} \quad (21)$$

As shown in Figure 37, the output signal will be typically seven hundred times above the noise level.

In many cases, a typical calculation is insufficient. To perform the worst-case analysis, assume that the signal-to-noise ratio at the MFOD2404 output must be 20 dB. Figure 37 shows the maximum noise output voltage is 1.0 mV. Therefore, the output signal must be 10 mV. With a worst-case responsivity of 23 mV/µW, the received power must be:

$$P_R = V_O/R = 10 \text{ mV}/23 \text{ mV}/\mu\text{W} = 0.43 \mu\text{W} \quad (22)$$

$$P_R = 10 \log (0.00043 \text{ mW}/1.0 \text{ mW}) = -34 \text{ dBm} \quad (23)$$

MOTOROLA SEMICONDUCTOR TECHNICAL DATA

Fiber Optics — High Performance Family Infrared LED

... designed for fiber optics applications requiring high-power and medium response times.

- Response — Digital Data to 30 Mbaud (NRZ) Guaranteed
- High Launch Power
- Internal Lensing Enhances Coupling Efficiency
- Complements All Motorola Fiber Optics Detectors
- Compatible with AMP #228756-1, Amphenol #905-138-5001 and Deutsch 3146-04
- Respects Using Motorola Alignment Bushing MFOA06 (Included)

MFOE1100, MFOE1101, MFOE1102

HERMETIC FAMILY FIBER OPTICS INFRARED LED

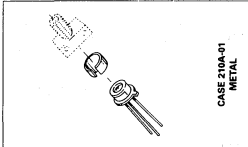

CASE 310A-01 METAL

MAXIMUM RATINGS			
Rating	Symbol	Value	Unit
Reverse Current	I_R	1	mA
Forward Current — Continuous	I_F	100	mA
Peak Output Pulsation (at $T_A = 25^\circ\text{C}$)	P_D	2.2	mW
Operating Temperature Range	T_A	-55 to +125	$^\circ\text{C}$
Storage Temperature Range	T_{stg}	-65 to +150	$^\circ\text{C}$

THERMAL CHARACTERISTICS			
Characteristics	Symbol	Max	Unit
Thermal Resistance, Junction to Ambient	θ_{JA}	440	$^\circ\text{C/W}$

ELECTRICAL CHARACTERISTICS ($T_A = 25^\circ\text{C}$)					
Characteristic	Symbol	Min	Typ	Max	Unit
Reverse Breakdown Voltage ($I_R = 100 \mu\text{A}$)	V_{BR}	2	8	—	Volts
Forward Voltage ($I_F = 100 \text{ mA}$)	V_F	1.8	2	2.2	Volts
Total Capacitance ($V_R = 0 \text{ V}, I = 1 \text{ MHz}$)	CT	—	70	—	pF
Electrical Bandwidth, Figure 6 ($I_F = 80 \text{ mA dc}$, measured 1 MHz to 30 MHz)	BWE	15	20	—	MHz

OPTICAL CHARACTERISTICS ($T_A = 25^\circ\text{C}$)					
Characteristic	Symbol	Min	Typ	Max	Unit
Total Power Output ($I_F = 100 \text{ mA}, A = 850 \text{ nm}$)	PO	—	2.6	—	mW
Power Launched, Figure 7 ($I_F = 100 \text{ mA}$)	PL	60 (-12.2)	—	—	$\mu\text{W}(\text{dBm})$
Nominal Wavelength of Output Fiber (at -10 dB), Figure 5 ($I_F = 250 \mu\text{m}$ (10 mil diameter spool))	NA	120 (-9.2)	160 (-7.5)	240 (-6.2)	nm
Waveheight of Peak Emission @ 100 mADC	A	—	850	—	nm
Special Line Height	t_r	—	50	—	mm
Optical Rise and Fall Times, Figure 11 ($I_F = 100 \text{ mADC}$)	t_f	—	15	—	ns

*Installed in compatible metal connector housing with Motorola alignment bushing.

MFOE1100, MFOE1101, MFOE1102

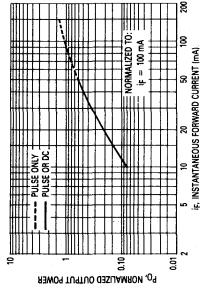

Figure 1. Normalized Output Power versus Forward Current

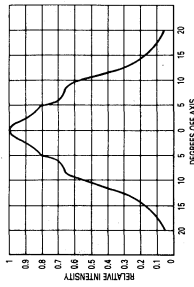

Figure 2. Power Output versus Junction Temperature

Figure 3. Radial Intensity Distribution

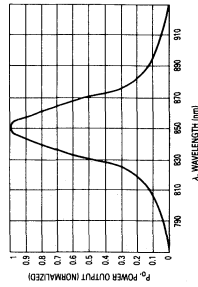

Figure 4. Forward Current versus Forward Voltage

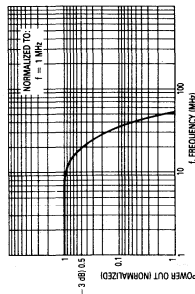

Figure 5. Normalized Output Power versus Frequency

Figure 6. Normalized Output Power versus Wavelength

Figure 36. MFOE1100 Series Data Sheet

MOTOROLA
SEMICONDUCTOR
TECHNICAL DATA

Fiber Optics — High Performance Family
Photo Detector
Preamplifier Output

... designed as a monolithic integrated circuit containing both detector and preamplifier for use in medium bandwidth, medium distance systems. It is packaged in Motorola's standard TO-206AC (170-52) package which provides excellent RF immunity. The output of the device is low impedance to provide even less sensitivity to stray interference. The MFOD2404 has a 300 μm (12 mil) optical spot with a high numerical aperture.

- Usable for Data Systems Up to 10 Megabaud
- Dynamic Range Greater than 100:1
- High Ambient Temperature Operation (up to 125°C)
- Microcircuit Mount Backstop MFOD48 (included)
- Performance Matched to Motorola Fiber Optics Emitter
- TO-206AC (170-52) Package — Small, Rugged and Hermetic
- 300 μm (12 mil) Diameter Optical Spot

MFOD2404

HERMETIC FAMILY
FIBER OPTICS
PHOTO DETECTOR
PREAMPLIFIER OUTPUT



CASE 210D-01
METAL

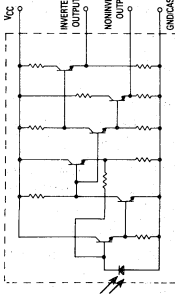

Figure 1. Equivalent Schematic

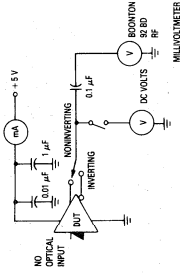

Figure 2. Typical Performance versus Temperature

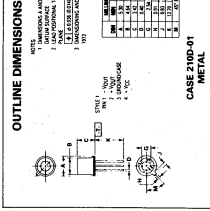

Figure 3. Outline Dimensions

NOTES:
1. DIMENSIONS ARE GIVEN IN MILLIMETERS.
2. DIMENSIONS IN PARENTHESES ARE PERMISSIBLE VARIATIONS.
3. DIMENSIONS IN BRACKETS ARE TYPICAL VALUES.

Symbol	Value	Unit
R_1	0.10	mm
R_2	0.10	mm
R_3	0.10	mm
R_4	0.10	mm
R_5	0.10	mm
R_6	0.10	mm
R_7	0.10	mm
R_8	0.10	mm
R_9	0.10	mm
R_{10}	0.10	mm
R_{11}	0.10	mm
R_{12}	0.10	mm
R_{13}	0.10	mm
R_{14}	0.10	mm
R_{15}	0.10	mm
R_{16}	0.10	mm
R_{17}	0.10	mm
R_{18}	0.10	mm
R_{19}	0.10	mm
R_{20}	0.10	mm
R_{21}	0.10	mm
R_{22}	0.10	mm
R_{23}	0.10	mm
R_{24}	0.10	mm
R_{25}	0.10	mm
R_{26}	0.10	mm
R_{27}	0.10	mm
R_{28}	0.10	mm
R_{29}	0.10	mm
R_{30}	0.10	mm

Figure 4. Test Circuit A

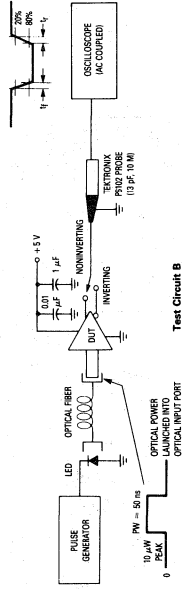

Figure 5. Test Circuit B

MAXIMUM RATINGS

Characteristic	Symbol	Value	Unit
Supply Voltage	V_{CC}	7.5	Volts
Operating Temperature Range	T_A	-55 to +125	°C
Storage Temperature Range	T_{stg}	-65 to +150	°C

ELECTRICAL CHARACTERISTICS ($V_{CC} = 5\text{ V}$, $T_A = 25^\circ\text{C}$)

Characteristic	Symbol	Conditions	Min	Typ	Max	Units
Power Supply Current	I_{CC}	Circuit A	3	3.5	5	mA
Quiescent dc Output Voltage (Noninverting Output)	V_O	Circuit A	0.5	0.6	0.7	Volts
Quiescent dc Output Voltage (Inverting Output)	V_O	Circuit A	2.7	3	3.3	Volts
RMS Noise Output	V_{NO}	Circuit A	—	0.4	1	mV

OPTICAL CHARACTERISTICS

Characteristic	Symbol	Conditions	Min	Typ	Max	Units
Responsivity ($V_{CC} = 5\text{ V}$, $P = 2\ \mu\text{W}$)	R	Circuit B	20	30	50	mV/ μW
Sensitivity (10 Mbits NRZ, BER = 10 ⁻⁵)	S	Circuit B	23	35	58	μW
Pulse Response	t_r, t_f	Circuit B	—	0.1	—	ns
Numerical Aperture of Input Port (300 μm (12 mil) diameter spot)	NA	—	—	0.5	—	—
Signal-to-Noise Ratio (@ $P_{in} = 1\ \mu\text{W}$ peak (Note 2))	S/N	—	—	35	—	dB
Minimum Detectable Power (Signal-to-Noise Ratio = 10, Pulse Output, $V_{CC} = 5\text{ V}$, Note 2)	P_{min}	—	—	—	30	μW

RECOMMENDED OPERATING CONDITIONS

Characteristic	Symbol	Value	Units
Supply Voltage	V_{CC}	4 to 6	Volts
Resistive Load (Either Output)	R_L	200	Ohms
Capacitive Load (Either Output)	C_L	—	100 pF
Input Wavelength	λ	—	850 nm

Notes: 1. As measured on either output (single-ended). 2. Power launched into SMA type device, respectively.

Figure 37. MFOD2404 Data Sheet

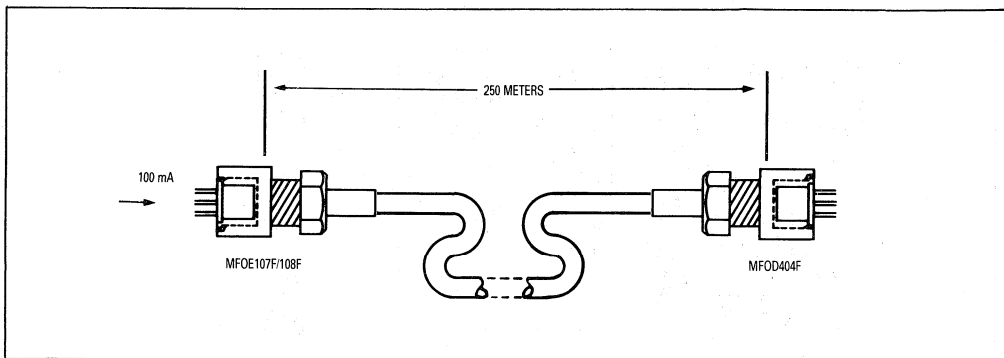

Figure 38. Simplex Fiber Optic Point To Point Link

It is advisable to allow for LED degradation over time. A good design may include 3.0 dB in the loss budget for long term degradation.

The link was already performed as worst case, so:

$$P_L = -34 \text{ dBm} + 3.0 \text{ dB} + 8.4 \text{ dB} = -22.6 \text{ dBm} \quad (24)$$

$$P_L = 10^{(-22.6/10)} \text{ mW} = 0.0055 \text{ mW} = 5.5 \mu\text{W} \quad (25)$$

Based on the Power Output versus Forward Current curve in Figure 36, it can be seen that the drive current (instantaneous forward current) necessary for 5.5 μW of power is about 8.0 mA.

Figure 36 also includes a Power Output versus Junction Temperature curve which, when used in conjunction with the thermal resistance of the package enables the designer to allow for higher drive currents as well as variations in ambient temperatures.

At 8.0 mA drive, the forward voltage will be less than 2.2 V worst case. Using 2.2 V will give a conservative analysis:

$$P_D = (8.0 \text{ mA})(2.2 \text{ V}) = 1.6 \text{ mW} \quad (26)$$

This is well within the maximum rating for operation at 25°C ambient. If we assume the ambient will be 25°C or less, the junction temperature can be conservatively calculated. Installed in a compatible metal connector:

$$\Delta T_J = (225^\circ\text{C/W})(0.0176 \text{ W}) = 3.9^\circ\text{C}$$

If we are transmitting digital data, we can assume an average duty cycle of 50% so the ΔT_J will likely be less than 2°C. This gives:

$$T_J = T_A + \Delta T_J = 27^\circ\text{C} \quad (28)$$

The power derating curve shows a value of essentially 1 due to T_J and T_A being so close under these conditions. Thus the required dc power level needs to be:

$$P_L(\text{dc}) = 5.5 \mu\text{W} \quad (29)$$

As Figure 36 indicates, increasing the drive current to 15 mA would provide greater than 10 μW launched power and only increase the junction temperature by about 1°C. This analysis shows the link to be more than adequate under the worst case conditions.

RISE TIME BUDGET

The cable for this system was specified to have a bandwidth of 100 MHz-km. Since the length of the system is 1.0 km, the system bandwidth, if limited by the cable, is 100 MHz. Data links are usually rated in terms of a rise time budget. The system rise time is found by taking the square root of the sum of the squares of the individual elements. In this system the only two elements to consider are the LED and the detector. Thus:

$$t_{RS} = \sqrt{(t_{R-LED})^2 + (t_{R-detector})^2} \quad (30)$$

Using the typical values from Figures 36 and 37:

$$t_{RS} = \sqrt{(15)^2 + (35)^2} = 38 \text{ ns} \quad (31)$$

Total system performance may be impacted by including the rise time of additional circuit elements. Additional considerations are covered in detail in AN-794 and the Designer's Guide mentioned earlier (see Bibliography).

DATA ENCODING FORMAT

In a typical digital system, the coding format is usually NRZ, or non-return to zero. In this format, a string of ones would be encoded as a continuous high level. Only when there is a change of state to a "0" would the signal level drop to zero. In RTZ (return to zero) encoding, the first half of a clock cycle would be high for a "1" and low for a "0." The second half would be low in either case. Figure 39 shows an NRZ and RTZ waveform for a binary data stream. Note between a-b the RTZ pulse rate repetition rate is at its highest. The highest bit rate requirement for an RTZ system is a string of "1's." The highest bit rate for an NRZ system is for alternating "1's" and "0's," as shown from b-c. Note that the highest NRZ bit rate is half the highest RTZ bit rate, or an RTZ system would require twice the bandwidth of an NRZ system for the same data rate.

However, to minimize drift in a receiver, it will probably be ac coupled; but if NRZ encoding is used and a long string of "1's" is transmitted, the ac coupling will result in lost data in the receiver. With RTZ data, data is not lost with ac coupling since only a string of "0's" results in a

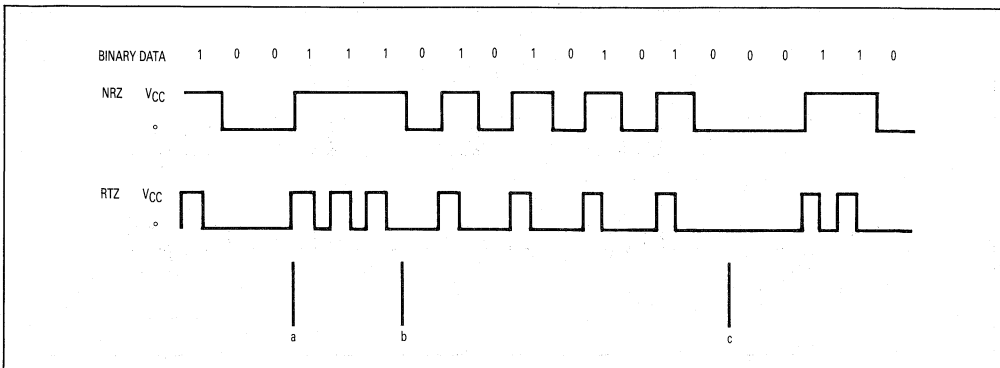

Figure 39. NRZ and RTZ Encoded Data

constant signal level; but that level is itself zero. However, in the case of both NRZ and RTZ, any continuous string of either "1's" or "0's" for NRZ or "0's" for RTZ will prevent the receiver from recovering any clock signal.

Another format, called Manchester encoding, solves this problem, by definition, in Manchester, the polarity reverses once each bit period regardless of the data. This is shown in Figure 40. The large number of level transitions enables the receiver to derive a clock signal even if all "1's" or all "0's" are being received.

In many cases, clock recovery is not required. It might appear that RTZ would be a good encoding scheme for these applications. However, many receivers include automatic gain control (AGC). During a long stream of "0's," the AGC could crank the receiver gain up; and when "1's" data begin to appear, the receiver may saturate. A good encoding scheme for these applications is

pulse bipolar encoding. This is shown in Figure 41. The transmitter runs at a quiescent level and is turned on harder for a short duration during a data "0" and is turned off for a short duration during a data "1."

Additional details on encoding schemes can be obtained from recent texts on data communications or pulse code modulation.

SUMMARY

This note has presented the basic principles that govern the coupling and transmission of light over optical fibers and the design considerations and advantages of using optical fibers for communication information in the form of modulated light.

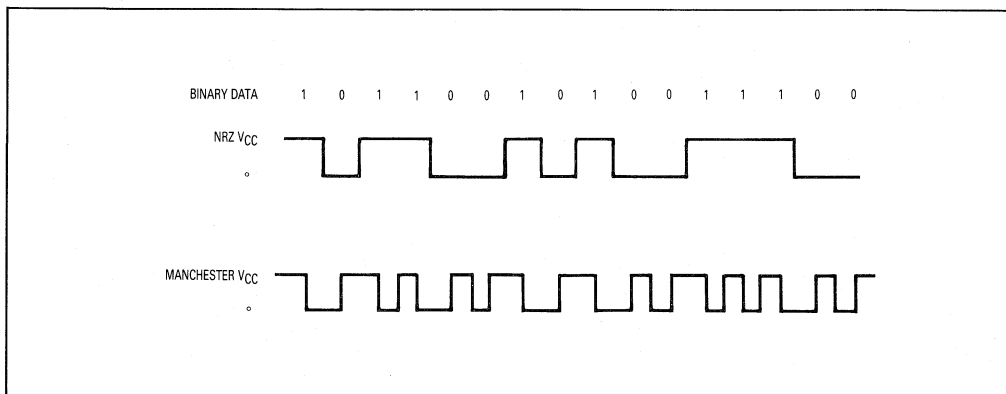

Figure 40. Manchester Data Encoding

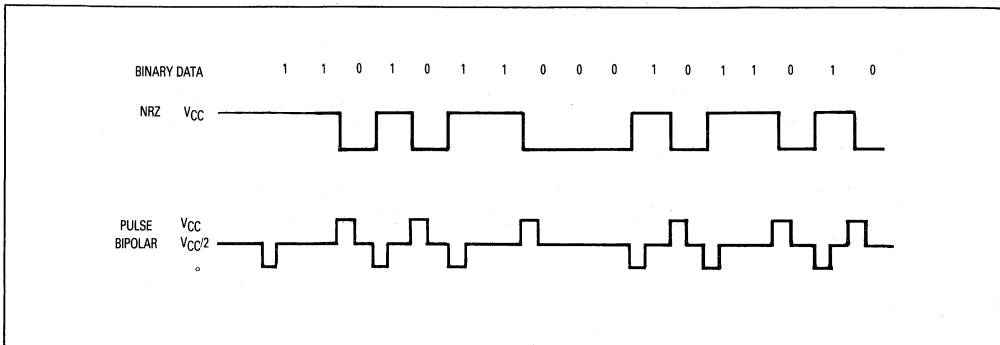

Figure 41. Pulse Bipolar Encoding

REFERENCES

1. Mirtich, Vincent L.; "A 20-M Baud Full Duplex Fiber Optic Data Link Using Fiber Optic Active Components." Motorola Application Note AN-794; Phoenix, Arizona, 1980.
2. Mirtich, Vincent L.; "Designer's Guide to: Fiber-Optic Data Links." Parts 1, 2, & 3; EDN June 20, 1980; August 5, 1980; and August 20, 1980.
3. Palais, Joseph. "Fiber Optic Communications," pp 164-187. Englewood Cliffs, N.J.; Prentice-Hall, Inc., 1988.

Applications of Zero Voltage Crossing Optically Isolated Triac Drivers

Prepared by Horst Gempe

INTRODUCTION

The zero-cross family of optically isolated triac drivers is an inexpensive, simple and effective solution for interface applications between low current dc control circuits such as logic gates and microprocessors and ac power loads (120, 240 or 380 volt, single or 3-phase).

These devices provide sufficient gate trigger current for high current, high voltage thyristors, while providing a guaranteed 7.5 kV dielectric withstand voltage between the line and the control circuitry. An integrated, zero-crossing switch on the detector chip eliminates current surges and the resulting electromagnetic interference (EMI) and reliability problems for many applications. The high transient immunity of 5000 V/ μ s, combined with the features of low coupling capacitance, high isolation resistance and up to 800 volt specified V_{DRM} ratings qualify this triac driver family as the ideal link between sensitive control circuitry and the ac power system environment.

Optically isolated triac drivers are not intended for stand alone service as are such devices as solid state relays. They will, however, replace costly and space demanding discrete drive circuitry having high component count consisting of standard transistor optoisolators, support components including a full wave rectifier bridge, discrete transistors, trigger SCRs and various resistor and capacitor combinations.

This paper describes the operation of a basic driving circuit and the determination of circuit values needed for proper implementation of the triac driver. Inductive loads are discussed along with the special networks required

to use triacs in their presence. Brief examples of typical applications are presented.

CONSTRUCTION

The zero-cross family consists of a liquid phase EPI, infrared, light emitting diode which optically triggers a silicon detector chip. A schematic representation of the triac driver is shown in Figure 1. Both chips are housed in a small, 6-pin dual-in-line (DIP) package which provides mechanical integrity and protection for the semiconductor chips from external impurities. The chips are insulated by an infrared transmissive medium which reliably isolates the LED input drive circuits from the environment of the ac power load. This insulation system meets the stringent requirements for isolation set forth by regulatory agencies such as UL and VDE.

THE DETECTOR CHIP

The detector chip is a complex monolithic IC which contains two infrared sensitive, inverse parallel, high voltage SCRs which function as a light sensitive triac. Gates of the individual SCRs are connected to high speed zero crossing detection circuits. This insures that with a continuous forward current through the LED, the detector will not switch to the conducting state until the applied ac voltage passes through a point near zero. Such a feature not only insures lower generated noise (EMI) and inrush (surge) currents into resistive loads and moderate inductive loads but it also provides high noise immunity (several thousand V/ μ s) for the detection circuit.

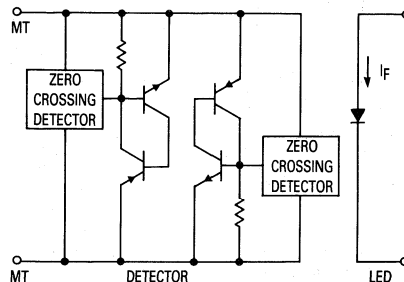

Figure 1. Schematic of Zero Crossing Optically Isolated Triac Driver

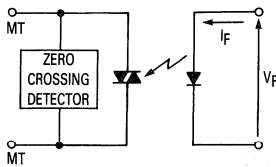

Figure 2. Simplified Schematic of Isolator

ELECTRICAL CHARACTERISTICS

A simplified schematic of the optically isolated triac driver is shown in Figure 2. This model is sufficient to describe all important characteristics. A forward current flow through the LED generates infrared radiation which triggers the detector. This LED trigger current (I_F) is the maximum guaranteed current necessary to latch the triac driver and ranges from 5 mA for the MOC3063 to 15 mA for the MOC3061. The LED's forward voltage drop at $I_F = 30$ mA is 1.5 V maximum. Voltage-current characteristics of the triac are identified in Figure 3.

Once triggered, the detector stays latched in the "on state" until the current flow through the detector drops below the holding current (I_H) which is typically 100 μ A. At this time, the detector reverts to the "off" (non-conducting) state. The detector may be triggered "on" not only by I_F but also by exceeding the forward blocking voltage between the two main terminals (MT1 and MT2) which is a minimum of 600 volts for all MOC3061 family members. Also, voltage ramps (transients, noise, etc.) which are common in ac power lines may trigger the detector accidentally if they exceed the static dV/dt rating. Since the fast switching, zero-crossing switch provides a minimum dV/dt of 500 V/ μ s even at an ambient temperature of 70°C, accidental triggering of the triac

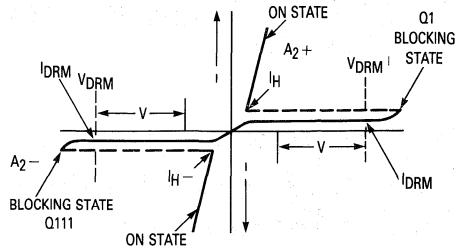

Figure 3. Triac Voltage-Current Characteristic

driver is unlikely. Accidental triggering of the main triac is a more likely occurrence. Where high dV/dt transients on the ac line are anticipated, a form of suppression network commonly called a "snubber" must be used to prevent false "turn on" of the main triac. A detailed discussion of a "snubber" network is given under the section "Inductive and Resistive Loads."

Figure 4 shows a static dV/dt test circuit which can be used to test triac drivers and power triacs. The proposed test method is per EIA/NARM standard RS-443.

Tests on the MOC3061 family of triac drivers using the test circuit of Figure 4 have resulted in data showing the effects of temperature and voltage transient amplitude on static dV/dt. Figure 5 is a plot of dV/dt versus ambient temperature while Figure 6 is a similar plot versus transient amplitude.

BASIC DRIVING CIRCUIT

Assuming the circuit shown in Figure 7 is in the blocking or "off" state (which means I_F is zero), the full ac line voltage appears across the main terminals of both the triac and the triac driver. When sufficient LED current (I_F) is supplied and the ac line voltage is below the inhibit voltage (I_H in Figure 3), the triac driver latches "on." This action introduces a gate current in the main triac trig-

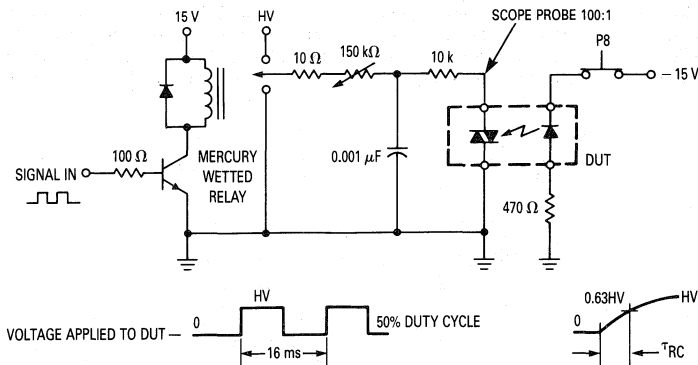

TEST PROCEDURE —

Turn the D.U.T. on, while applying sufficient dV/dt to ensure that it remains on, even after the trigger current is removed. Then decrease dV/dt until the D.U.T. turns off. Measure τ_{RC} , the time it takes to rise to 0.63 HV, and divide 0.63 HV by τ_{RC} to get dV/dt.

Figure 4. Static dV/dt Test Circuit

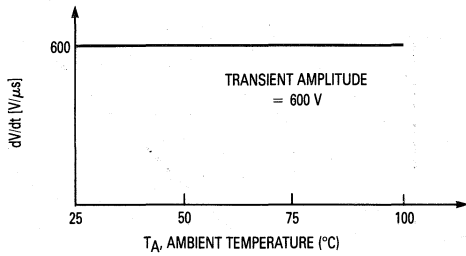

Figure 5. Static dv/dt versus Temperature

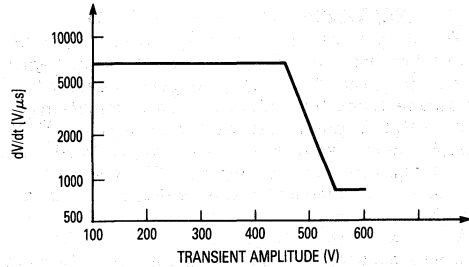

Figure 6. Static dv/dt versus Transient Amplitude

gering it from the blocking state into full conduction. Once triggered, the voltage across the main terminals collapses to a very low value which results in the triac driver output current decreasing to a value lower than its holding current, thus forcing the triac driver into the "off" state, even when I_{FT} is still applied.

The power triac remains in the conducting state until the load current drops below the power triac's holding current, a situation that occurs every half cycle. The actual duty cycle for the triac driver is very short (in the 1 to 3 μ s region). When I_{FT} is present, the power triac will be retriggered every half cycle of the ac line voltage until I_{FT} is switched "off" and the power triac has gone through a zero current point. (See Figure 8).

Resistor R (shown in Figure 7) is not mandatory when R_L is a resistive load since the current is limited by the gate trigger current (I_{GT}) of the power triac. However, resistor R (in combination with R-C snubber networks that are described in the section "Inductive and Resistive Loads") prevents possible destruction of the triac driver in applications where the load is highly inductive.

Unintentional phase control of the main triac may happen if the current limiting resistor R is too high in value. The function of this resistor is to limit the current through the triac driver in case the main triac is forced into the non-conductive state close to the peak of the line voltage

and the energy stored in a "snubber" capacitor is discharged into the triac driver. A calculation for the current limiting resistor R is shown below for a typical 220 volt application: Assume the line voltage is 220 volts RMS. Also assume the maximum peak repetitive driver current (normally for a 10 micro second maximum time interval) is 1 ampere. Then

$$R = \frac{V_{peak}}{I_{peak}} = \frac{220 \sqrt{2} \text{ volts}}{1 \text{ amp}} = 311 \text{ ohms}$$

One should select a standard resistor value >311 ohms \rightarrow 330 ohms.

The gate resistor R_G (also shown in Figure 7) is only necessary when the internal gate impedance of the triac or SCR is very high which is the case with sensitive gate thyristors. These devices display very poor noise immunity and thermal stability without R_G . Value of the gate resistor in this case should be between 100 and 500. The circuit designer should be aware that use of a gate resistor increases the required trigger current (I_{GT}) since R_G drains off part of I_{GT} . Use of a gate resistor combined with the current limiting resistor R can result in an unintended delay or phase shift between the zero-cross point and the time the power triac triggers.

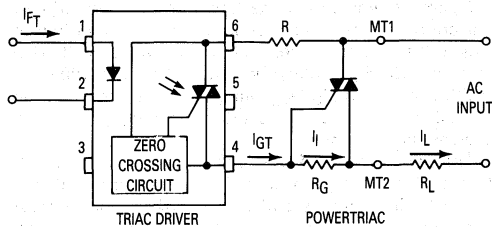

Figure 7. Basic Driving Circuit — Triac Driver, Triac and Load

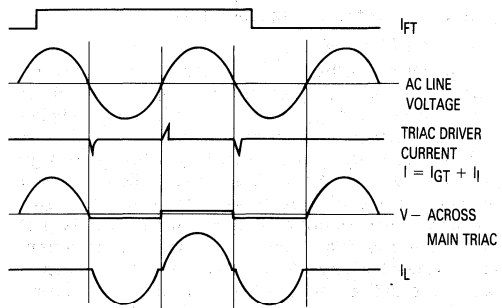

Figure 8. Waveforms of a Basic Driving Circuit

UNINTENDED TRIGGER DELAY TIME

To calculate the unintended time delay, one must remember that power triacs require a specified trigger current (I_{GT}) and trigger voltage (V_{GT}) to cause the triac to become conductive. This necessitates a minimum line voltage V_T to be present between terminals MT1 and MT2 (see Figure 7), even when the triac driver is already triggered "on." The value of minimum line voltage V_T is calculated by adding all the voltage drops in the trigger circuit:

$$V_T = V_R + V_{TM} + V_{GT}$$

Current I in the trigger circuit consists not only of I_{GT} but also the current through R_G :

$$I = I_{RG} + I_{GT}$$

Likewise, I_{RG} is calculated by dividing the required gate trigger voltage V_{GT} for the power triac by the chosen value of gate resistor R_G :

$$I_{RG} = V_{GT}/R_G$$

Thus, $I = V_{GT}/R_G + I_{GT}$.

All voltage drops in the trigger circuit can now be determined as follows:

$$V_R = I \times R = V_{GT}/R_G \times R + I_{GT} \times R = R(V_{GT}/R_G + I_{GT})$$

V_{TM} = From triac driver data sheet

V_{GT} = From power triac data sheet.

I_{GT} = From power triac data sheet.

With V_{TM} , V_{GT} and I_{GT} taken from data sheets, it can be seen that V_T is only dependent on R and R_G .

Knowing the minimum voltage between MT1 and MT2 (line voltage) required to trigger the power triac, the unintended phase delay angle θ_d (between the ideal zero crossing of the ac line voltage and the trigger point of the power triac) and the trigger delay time t_d can be determined as follows:

$$\begin{aligned} \theta_d &= \sin^{-1} V_T/V_{peak} \\ &= \sin^{-1} \frac{R(V_{GT}/R_G + I_{GT}) + V_{TM} + V_{GT}}{V_{peak}} \end{aligned}$$

The time delay t_d is the ratio of θ_d to $\theta_{V_{peak}}$ (which is 90 degrees) multiplied by the time it takes the line voltage to go from zero voltage to peak voltage (simply $1/4f$, where f is the line frequency). Thus

$$t_d = \theta_d/90 \times 1/4f$$

Figure 9 shows the trigger delay of the main triac versus the value of the current limiting resistor R for assumed values of I_{GT} . Other assumptions made in plotting the equation for t_d are that line voltage is 220 V RMS which leads to $V_{peak} = 311$ volts; $R_G = 300$ ohms; $V_{GT} = 2$ volts and $f = 60$ Hz. Even though the triac driver triggers close to the zero cross point of the ac voltage, the power triac cannot be triggered until the voltage of the ac line rises high enough to create enough current flow to latch the power triac in the "on" state. It is apparent that significant time delays from the zero crossing point can be observed when R is a large value along with a high value of I_{GT} and/or a low value of R_G . It should

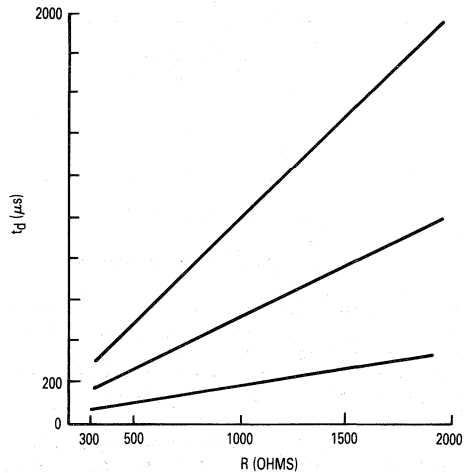

Figure 9. Time Delay t_d versus Current Limiting Resistor R

be remembered that low values of the gate resistor improve the dV/dt ratings of the power triac and minimize self latching problems that might otherwise occur at high junction temperatures.

SWITCHING SPEED

The switching speed of the triac driver is a composition of the LED's turn on time and the detector's delay, rise and fall times. The harder the LED is driven the shorter becomes the LED's rise time and the detector's delay time. Very short I_{FT} duty cycles require higher LED currents to guarantee "turn on" of the triac driver consistent with the speed required by the short trigger pulses.

Figure 10 shows the dependency of the required LED current normalized to the dc trigger current required to trigger the triac driver versus the pulse width of the LED current. LED trigger pulses which are less than $100 \mu s$ in width need to be higher in amplitude than specified on the data sheet in order to assure reliable triggering of the triac driver detector.

The switching speed test circuit is shown in Figure 11. Note that the pulse generator must be synchronized with the 60 Hz line voltage and the LED trigger pulse must occur near the zero cross point of the ac line voltage. Peak ac current in the curve tracer should be limited to 10 mA. This can be done by setting the internal load resistor to 3 k ohms.

Motorola isolated triac drivers are trigger devices and designed to work in conjunction with triacs or reverse parallel SCRs which are able to take rated load current. However, as soon as the power triac is triggered there is no current flow through the triac driver. The time to turn the triac driver "off" depends on the switching speed of the triac, which is typically on the order of 1–2 μs .

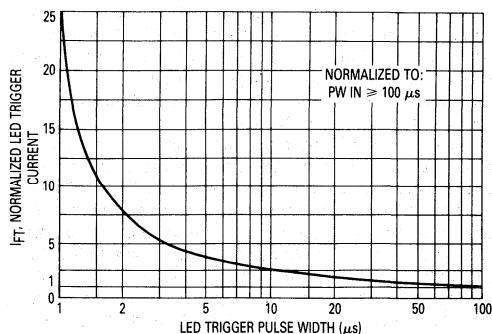

Figure 10. I_{FT} Normalized to $I_{FT\text{ dc}}$ As Specified on the Data Sheet

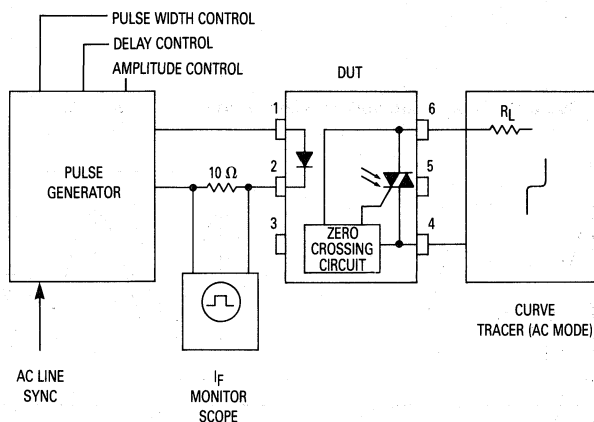

Figure 11. Test Circuit for LED Forward Trigger Current versus Pulse Width

INDUCTIVE AND RESISTIVE LOADS

Inductive loads (motors, solenoids, etc.) present a problem for the power triac because the current is not in phase with the voltage. An important fact to remember is that since a triac can conduct current in both directions, it has only a brief interval during which the sine wave current is passing through zero to recover and revert to its blocking state. For inductive loads, the phase shift between voltage and current means that at the time the current of the power handling triac falls below the holding current and the triac ceases to conduct, there exists a certain voltage which must appear across the triac. If this voltage appears too rapidly, the triac will resume conduction and control is lost. In order to achieve control with certain inductive loads, the rate of rise in voltage (dV/dt) must be limited by a series RC network placed in parallel with the power triac. The capacitor C_S will limit the dV/dt across the triac.

The resistor R_S is necessary to limit the surge current from C_S when the triac conducts and to damp the ringing of the capacitance with the load inductance L_L . Such an RC network is commonly referred to as a "snubber."

Figure 12 shows current and voltage wave forms for the power triac. Commutating dV/dt for a resistive load is typically only $0.13\text{ V}/\mu\text{s}$ for a 240 V, 50 Hz line source and $0.063\text{ V}/\mu\text{s}$ for a 120 V, 60 Hz line source. For inductive loads the "turn off" time and commutating dV/dt stress are more difficult to define and are affected by a number of variables such as back EMF of motors and the ratio of inductance to resistance (power factor). Although it may appear from the inductive load that the rate or rise is extremely fast, closer circuit evaluation reveals that the commutating dV/dt generated is restricted to some finite value which is a function of the load reactance L_L and the device capacitance C but still may exceed the triac's critical commutating dV/dt rating which is about $50\text{ V}/\mu\text{s}$.

It is generally good practice to use an RC snubber network across the triac to limit the rate of rise (dV/dt) to a value below the maximum allowable rating. This snubber network not only limits the voltage rise during commutation but also suppresses transient voltages that may occur as a result of ac line disturbances.

There are no easy methods for selecting the values for R_S and C_S of a snubber network. The circuit of Figure 13 is a damped, tuned circuit comprised of R_S , C_S , R_L and L_L , and to a minor extent the junction capacitance of the triac. When the triac ceases to conduct (this occurs every half cycle of the line voltage when the current falls below the holding current), the load current receives a step impulse of line voltage which depends on the power factor of the load. A given load fixes R_L and L_L ; however, the circuit designer can vary R_S and C_S . Commutating dV/dt can be lowered by increasing C_S while R_S can be increased to decrease resonant "over ringing" of the tuned circuit. Generally this is done experimentally

beginning with values calculated as shown in the next section and, then, adjusting R_S and C_S values to achieve critical damping and a low critical rate of rise of voltage.

Less sensitive to commutating dV/dt are two SCRs in an inverse parallel mode often referred to as a back-to-back SCR pair (see Figure 15). This circuit uses the SCRs in an alternating mode which allows each device to recover and turn "off" during a full half cycle. Once in the "off" state, each SCR can resist dV/dt to the critical value of about $100 V/\mu s$. Optically isolated triac drivers are ideal in this application since both gates can be triggered by one triac driver which also provides isolation between the low voltage control circuit and the ac power line.

It should be mentioned that the triac driver detector does not see the commutating dV/dt generated by the inductive load during its commutation; therefore, the commutating dV/dt appears as a static dV/dt across the two main terminals of the triac driver.

Figure 12. Current and Voltage Waveforms During Commutation

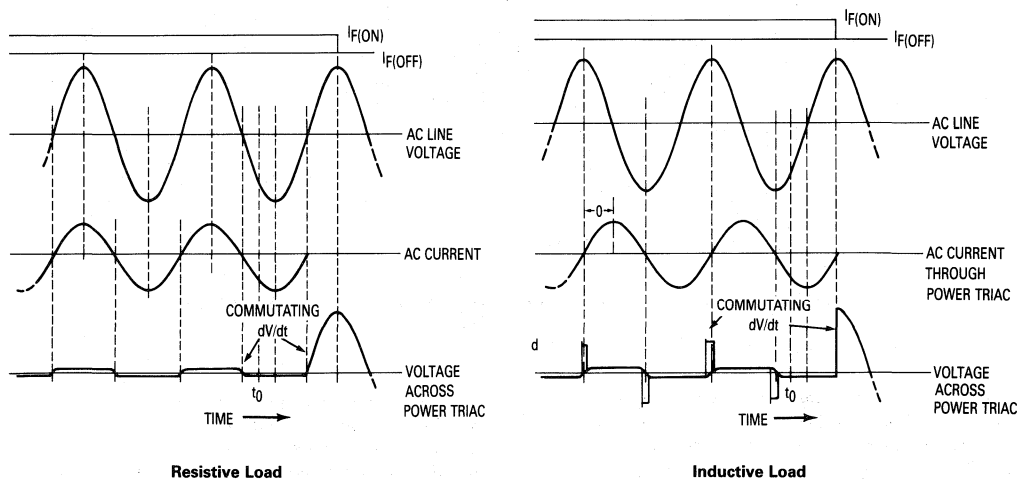

SNUBBER DESIGN — THE RESONANT METHOD

If R, L and C are chosen to resonate, the voltage waveform on dV/dt will look like Figure 14. This is the result of a damped quarter-cycle of oscillation. In order to calculate the components for snubbing, the dV/dt must be related to frequency. Since, for a sine wave,

$$V(t) = V_p \sin \omega t$$

$$dV/dt = V_p \omega \cos t \omega$$

$$dV/dt(\max) = V_p \omega = V_p 2\pi f$$

$$f = \frac{dV/dt}{2\pi V_A(\max)}$$

Where dV/dt is the maximum value of off state dV/dt specified by the manufacturer.

From:

$$f = \frac{1}{2\pi\sqrt{LC}}$$

$$C = \frac{1}{(2\pi f)^2 L}$$

We can choose the inductor for convenience. Assuming the resistor is chosen for the usual 30% overshoot:

$$R = \sqrt{\frac{L}{C}}$$

Assuming L is 50 μH, then:

$$f = \frac{(dV/dt)_{\min}}{2\pi V_A(\max)} = \frac{50 \text{ V}/\mu\text{s}}{2\pi(294 \text{ V})} = 27 \text{ kHz}$$

$$C = \frac{1}{(2\pi f)^2 L} = 0.69 \mu\text{F}$$

$$R = \sqrt{\frac{L}{C}} = \sqrt{\frac{50 \mu\text{H}}{0.69 \mu\text{F}}} = 8.5 \Omega$$

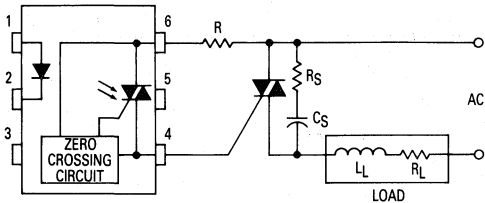

Figure 13. Triac Driving Circuit — with Snubber

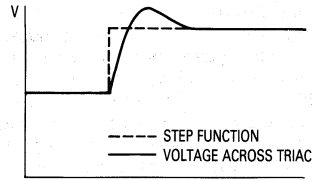

Figure 14. Voltage Waveform After Step Voltage Rise — Resonant Snubbing

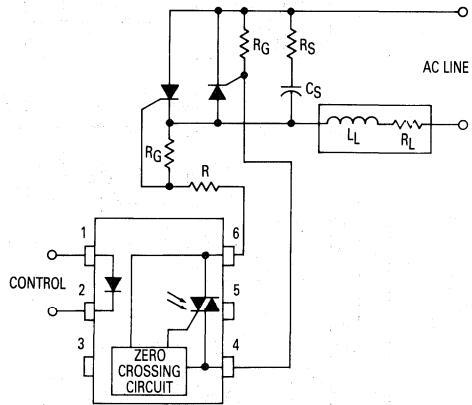

Figure 15. A Circuit Using Inverse Parallel SCRs

INRUSH (SURGE) CURRENTS

The zero crossing feature of the triac driver insures lower generated noise and sudden inrush currents on resistive loads and moderate inductive loads. However, the user should be aware that many loads even when started at close to the ac zero crossing point present a very low impedance. For example, incandescent lamp filaments when energized at the zero crossing may draw ten to twenty times the steady state current that is drawn when the filament is hot. A motor when started pulls a "locked rotor" current of, perhaps, six times its running current. This means the power triac switching these loads must be capable of handling current surges without junction overheating and subsequent degradation of its electrical parameters.

Almost pure inductive loads with saturable ferromagnetic cores may display excessive inrush currents of 30 to 40 times the operating current for several cycles when

switched "on" at the zero crossing point. For these loads, a random phase triac driver (MOC3020 family) with special circuitry to provide initial "turn on" of the power triac at ac peak voltage may be the optimized solution.

ZERO CROSS, THREE PHASE CONTROL

The growing demand for solid state switching of ac power heating controls and other industrial applications has resulted in the increased use of triac circuits in the control of three phase power. Isolation of the dc logic circuitry from the ac line, the triac and the load is often desirable even in single phase power control applications. In control circuits for poly phase power systems, this type of isolation is mandatory because the common point of the dc logic circuitry cannot be referred to a common line in all phases. The MOC3061 family's characteristics of high off-state blocking voltage and high iso-

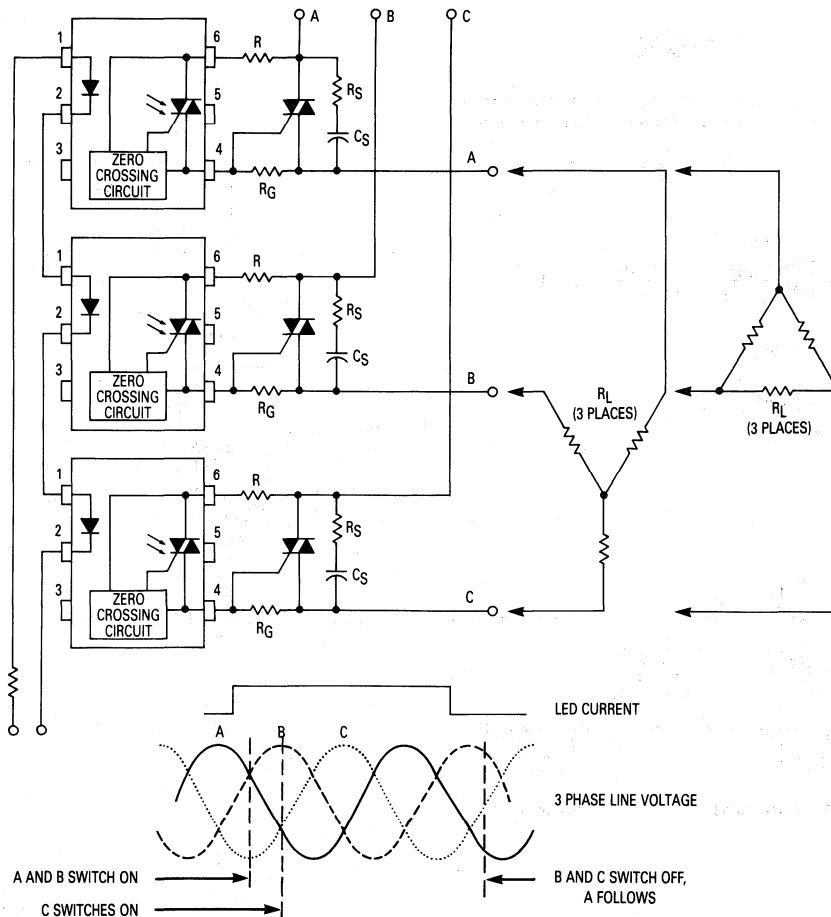

Figure 16. 3 Phase Control Circuit

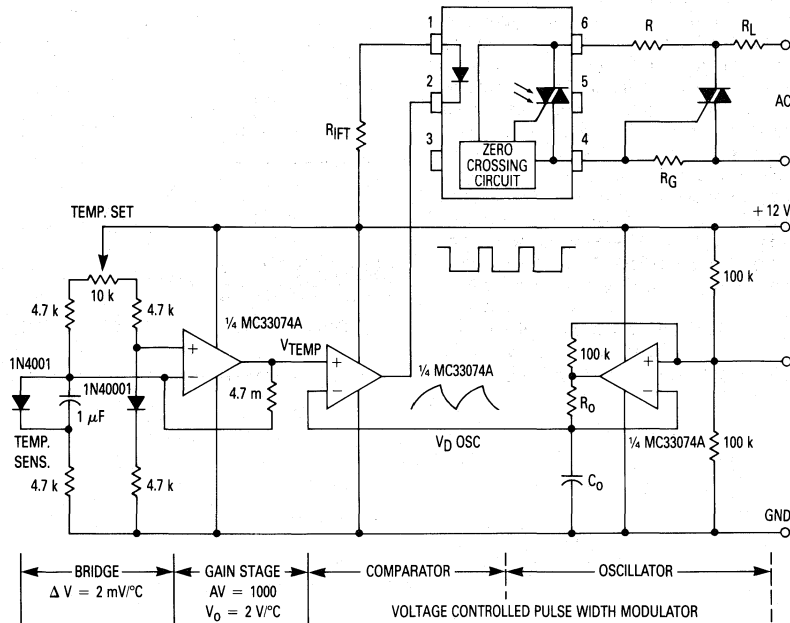

Figure 17. Proportional Zero Voltage Switching Temperature Controller

lation capability make the isolated triac drivers ideal devices for a simplified, effective control circuit with low component count as shown in Figure 16. Each phase is controlled individually by a power triac with optional snubber network (R_S , C_S) and an isolated triac driver with current limiting resistor R . All LEDs are connected in series and can be controlled by one logic gate or controller. An example is shown in Figure 17.

At startup, by applying I_F , the two triac drivers which see zero voltage differential between phase A and B or A and C or C and B (which occurs every 60 electrical degrees of the ac line voltage) will switch "on" first. The third driver (still in the "off" state) switches "on" when the voltage difference between the phase to which it is connected approaches the same voltage as the sum voltage (superimposed voltage) of the phases already switched "on." This guarantees zero current "turn on" of all three branches of the load which can be in Y or Delta configuration. When the LEDs are switched "off," all phases switch "off" when the current (voltage difference) between any two of the three phases drops below

the holding current of the power triacs. Two phases switched "off" create zero current. In the remaining phase, the third triac switches "off" at the same time.

PROPORTIONAL ZERO VOLTAGE SWITCHING

The built-in zero voltage switching feature of the zero-cross triac drivers can be extended to applications in which it is desirable to have constant control of the load and a minimization of system hysteresis as required in industrial heater applications, oven controls, etc. A closed loop heater control in which the temperature of the heater element or the chamber is sensed and maintained at a particular value is a good example of such applications. Proportional zero voltage switching provides accurate temperature control, minimizes overshoots and reduces the generation of line noise transients.

Figure 17 shows a low cost MC33074 quad op amp which provides the task of temperature sensing, amplification, voltage controlled pulse width modulation and triac driver LED control. One of the two 1N4001 diodes

AN982

(which are in a Wheatstone bridge configuration) senses the temperature in the oven chamber with an output signal of about 2 mV/°C. This signal is amplified in an inverting gain stage by a factor of 1000 and compared to a triangle wave generated by an oscillator. The comparator and triangle oscillator form a voltage controlled pulse width modulator which controls the triac driver. When the temperature in the chamber is below the desired value, the comparator output is low, the triac driver and the triac are in the conducting state and full power is applied to the load. When the oven temperature comes close to the desired value (determined by the "temp set" potentiometer), a duty cycle of less than 100% is introduced providing the heater with proportionally less power until equilibrium is reached. The proportional band can be controlled by the amplification of the gain stage — more gain provides a narrow band; less gain a wider band. Typical waveforms are shown in Figure 18.

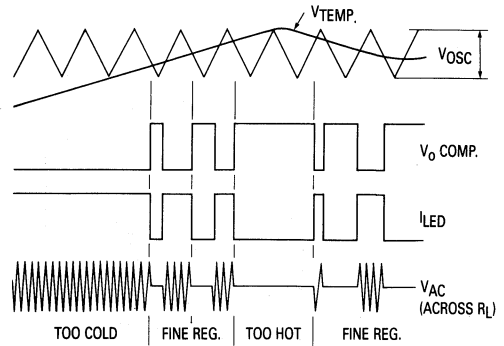

Figure 18. Typical Waveforms of Temperature Controller

Infrared Sensing and Data Transmission Fundamentals

Prepared by: Dave Hyder
 Field Applications Engineer

Many applications today benefit greatly from electrical isolation of assemblies, require remote control, or need to sense a position or presence. Infrared light is an excellent solution for these situations due to low cost, ease of use, ready availability of components, and freedom from licensing requirements or interference concerns that may be required by RF techniques. Construction of these systems is not difficult, but many designers are not familiar with the principles involved. The purpose of this application note is to present a "primer" on those techniques and thus speed their implementation.

THE GENERAL PROBLEM

Figure 1 represents a generalized IR system. The transmitting portion presents by far the simplest hurdle. All that needs to be accomplished is to drive the light source such that sufficient power is launched at the intended frequency to produce adequate reception. This is quite easy to do, and specific circuits will be presented later.

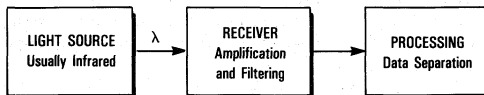

Figure 1. Simplified IR Sensing/Data Transmission System

The bulk of the challenge lies in the receiving area, with several factors to consider. The ambient light environment is a primary concern. Competing with the feeble IR transmitted signal are light sources of relatively high power, such as local incandescent sources, fluorescent lighting, and sunlight.

These contribute to the problem in two ways. First, they produce an ambient level of stimulation to the detector that appears as a dc bias which can cause decreased sensitivity and, worst of all, saturation in some types of detectors. Second, they provide a noise level often 60 dB greater than the desired signal, especially in the form of the 50 or 60 Hz power frequency. Also, recall that the sensitivity of silicon photo detectors extends well into the visible range. This sensitivity, albeit reduced, causes severe interference since the sources in this region are often of significant power, e.g., incandescent lighting and sunlight. In addition to the visible component, both produce large amounts of infrared energy, especially sunlight.

Some IR applications are not exposed to this competition, and for them dc excitation of the source may be adequate. These include some position sensing areas and slow data links over short distances.

But the bulk of IR needs require a distance greater than 30 cm, speeds greater than 300 baud, and exposure to interfering elements. For these needs high-frequency excitation of the source is necessary. This ac drive permits much easier amplification of the detected signal, filtering of lower frequency components, and is not difficult to produce at the driving end. Optical filtering for removal of the visible spectrum is usually required in addition to the electrical, but this too is quite simple.

A WORD ABOUT DETECTORS

Figure 2 shows the three basic detection schemes: a phototransistor, a Darlington phototransistor, and a photodiode. All three produce hole-electron pairs in response to photons striking a junction. This is seen as a current when they are swept across the junction by the bias voltage, but they differ greatly in other respects.

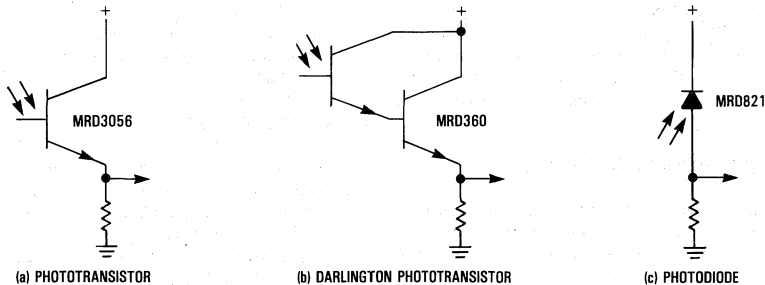

Figure 2. The Basic Detectors for IR Photosensing

The most sensitive is the Darlington. The penalties are temperature drift, very-low tolerance to saturation, and speeds, limited to about 5 kHz (usually much less). Next is the single transistor, having similar penalties (but to a lesser degree), with speeds limited to less than 10 kHz. Typically, they are limited to less than half that number. These two detectors normally find their use in enclosed environments, where ample source intensity is available to provide large voltage outputs without much additional circuitry (their prime advantage). Their detection area is almost never exposed to ambient light.

In virtually all remote-control applications (implying distance), the diode is the detector of choice. This is due primarily to its near-freedom from saturation, even in most sunlit environments. The penalty is sensitivity, often in the nanoamp or low microamp region, but balanced by response speed in the nanosecond range. This permits transmission frequencies in the 50–100 kHz area, providing ample data rates, inexpensive amplification, and easy filtering of noise.

For more information on the internal characteristics of these devices, see the appropriate section of the Motorola Optoelectronics data book (#DL118/D).

SHORT DISTANCES

Many applications in position sensing lend themselves well to the sensitive, if slow, nature of phototransistors. When a go, no-go situation exists, these provide a simple solution provided that ambient light is not present at the detector. The designer must ensure that the system operates even if this portion of the equipment is exposed, as by opening a hatch during servicing or final adjustment during production. This is often achieved via covers, tubes limiting light paths, or that enough directionality exists in the basic device construction to provide the needed isolation. Also available for this application are logic-level output devices, usually of the open-collector type, making processor or logic interfacing convenient.

The light source for these uses is chosen primarily by the distance needed. LEDs work well up to about 5 cm. Above this, incandescents are often used due to their high output and ease of drive with low-voltage ac. Fluorescent sources are seldom adequate due to their "cool" color temperature compared to incandescent. That is, not enough output in the near-infrared or infrared portion of the spectrum.

Data can be transmitted in these short distance situations, provided the speeds required are not great. An example is the electrical isolation of two adjacent PC boards in a rack, with IR elements facing each other across the short space. Here the data can be used to drive the LED directly; modulating a high frequency is not necessary.

Speed and sensitivity are the tradeoff. The resistor used to develop a voltage can be made larger to provide increased sensitivity, but speed suffers and tendency toward saturation increases. Values of 50–200 Ω are common, but can be higher.

MODERATE DISTANCES

For the general case of remote control or sensing at distances greater than 30 cm, the vast majority of applications utilize an LED source switched at a carrier frequency of 20 kHz to 50 kHz and a diode detector coupled to ac band-limited amplifiers. Although certainly more complex than the simpler short-distance sensors, today's product offerings make it an easy task

to achieve 10 meters with a data rate of around 5,000 baud at very modest cost.

The transmission end is easily configured. Figure 3 shows a simple IR source capable of 50 kHz transmission. Note that no special techniques are needed to switch the diode at these frequencies. A burst of high frequency is created for each bit time in the data being sent. This mode of gating a carrier on and off is known as CW (continuous wave).

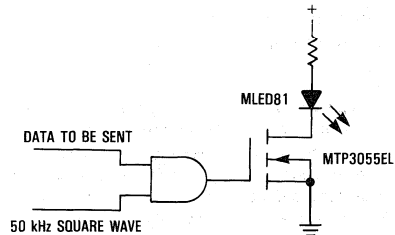

Figure 3. Basic IR Source Drive for CW Operation

The main areas of interest are the switch device and the diode current. Today's IREDs (infrared emitting diodes) are generally capable of around one ampere peak currents, but applications typically limit this to half that value. Most designs that use a 50 percent duty cycle square wave switching waveform have diode currents in the 100–500 mA range. It is important to realize that although IRED output increases linearly with drive current, it drops rapidly with increasing temperature. Therefore, reliability is not the only reason for resisting the temptation to increase range by driving the IRED harder. A diode with a 100 mA continuous rating can be reliably driven with a 200 mA square wave, and so on. It is quite common to use more than one IRED in series for increasing output and range, lowering the current requirements, and increasing reliability of the diodes.

The driver device can be a bipolar transistor or a FET. The bipolar works fine, but requires enough base current for saturation that the driving circuitry often must provide 10–20 mA or more. This may not be available directly from CMOS devices. Darlington's solve this problem, but are usually much too slow. Another solution is an inexpensive logic-level FET such as the MTP3055EL, its physically smaller cousin, the MTD3055EL, or a MTP4N06L. This provides plenty of speed while being driven directly from any CMOS device, with absolute minimum parts count. A resistor (50–500 Ω) is sometimes used in series with the gate to moderate the very-high switching speed and noise from high frequency oscillations. The resistor is usually not needed if the gate is driven from a medium-speed CMOS gate such as the MC14081B or MC14011UB.

THE RECEIVING PROCESS

At the receiving end, the first item encountered is an IR optical filter as shown in Figure 4. This serves the sole purpose of attenuating the visible portion of the spectrum while leaving the IR intact. It can be a material specifically designed for the purpose, such as the Kodak filter series, but is usually an inexpensive acrylic plastic. This is almost any readily-available red, non-opaque plastic. Suitability is easily proven by inserting a sample between an emitter and detector while observing the

detector output. The IR signal should be minimally altered. This filter may be incorporated into the system as a unique piece of the material in front of the detector, or the entire front panel of the product may be made of this plastic. Sometimes lenses are actually molded from it (discussed in a later section).

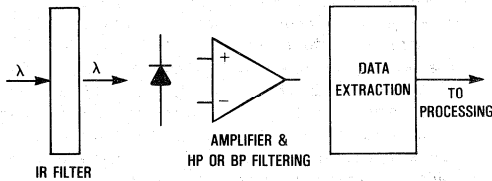

Figure 4. Basic IR Receiver

The detector diode behind the filter is usually constructed as a large-geometry device specifically designed for IR remote control, and presents a large area simply for more IR energy absorption or increased aperture. It is not unusual to find the material used for encapsulation to be red or black, and apparently opaque. The encapsulation serves as an IR filter, as in the case of the MRD821. Even so, an additional one is usually employed as mentioned above, often for the cosmetics of the product.

In addition to visible-light filtering mentioned above, electrical filtering must be applied to greatly attenuate the low-frequency interference present in both the visible spectrum and the IR. This is accomplished by three methods. First, coupling capacitance values are judiciously chosen to begin rolloff just below the transmitted frequency. This is quite effective since the area of interest is usually about a factor of 10^3 , or some 9 to 10 octaves above the power-line frequencies.

The second method is to use explicit high-pass filter circuitry, but in practice this is seldom needed due to the effectiveness of the other techniques. A third option is to use a bandpass amplifier, usually with an LC tank. More discussion of this later.

After the signal is brought up to a level sufficient for detection, some method must be employed to extract the data. Most common is a simple peak detector. This detects the presence of the high-frequency pulses, charging a capacitor up to a threshold in a few cycles, at which point a comparator signals the new level. In the absence of a signal (the carrier), the capacitor discharges until the comparator's lower threshold is reached, signifying the opposite logic level. Other techniques are also available, such as the phase-locked loop, whose lock-detect output can be used as the recovered logic-level data.

MORE ON RECEIVING CIRCUITS

Two general methods are used to begin the amplification. First the diode light current (a few microamps or less) may be used to develop a voltage across a series resistance, which is then capacitively coupled to the amplifier using the rolloff of low frequencies mentioned above, as shown in Figure 5a. Second, the current may be driven directly into the amplifier, as in Figure 5b, where the photo current is summed with the feedback current at the amplifier input. Note that in these and other figures, the amplifier symbol does not necessarily denote an actual integrated operational amplifier, but may symbolize a discrete amplifier.

Figure 6 shows an amplifier system coupled to a bandpass amplifier centered about 50 kHz. Here the front end is actually an operational amplifier, used in the mode of Figure 5b. Various choices for operational amplifiers exist; perhaps the first hinges

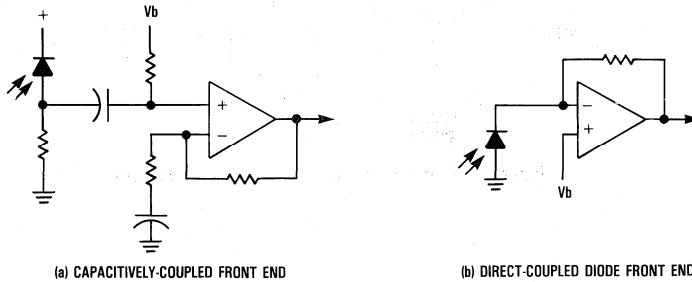
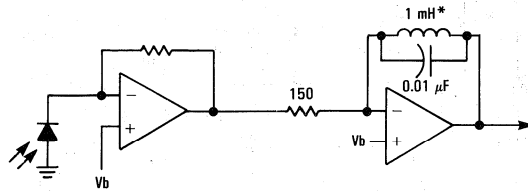

Figure 5. Front-End Amplifier Options



*Toko type 10 PA or equivalent. Available from Digi-Key Corporation, phone (800) 344-4539.

Figure 6. Amplifier Chain Showing 50 kHz Bandpass Filter Second Stage

on the supply voltage. Some recent advances in the technology have greatly increased slew rates and gain-bandwidth products. This has permitted devices that are capable of operation on a single 5 volt supply, yet can be used in the 50 kHz range. An example of this is the MC34072 series, whose input common mode range includes ground, permitting the diode or the other amplifier input to be referenced there. If greater gains are needed, and higher supply rails are available, the MC34082 series provides slew rates of 25 V/ μ s, or twice that of the MC34083. These operational amplifiers in general do not have the low-noise performance of discrete versions, with the above devices being in the 30 nV/ $\sqrt{\text{Hz}}$ region. However, the MC33077 provides excellent noise performance of about 4.5 nV/ $\sqrt{\text{Hz}}$ at a similar slew rate on a 5 volt supply, although its common mode range does not include ground. A simple discrete amplifier example is shown in Figure 7.

Another option that should be considered for data reception is the MC3373 (Figure 8), which integrates many of the functions already described. This device contains the front-end amplifier, a negative-peak detector with comparator, and requires only a few external components. The amplifier may

have the diode directly connected to it, or ac coupled for purposes of rolloff. A tuned circuit can be used for the better noise performance of a band-limited system. Some words of caution: supply bypassing close to the device, particularly at the gain-determining impedance (resistance or tuned circuit), is critical. Without proper bypassing, gain and range suffer. Also, a higher supply voltage of around 12 volts or so assists in greater range performance.

The vast majority of IR links in consumer products (VCRs, TVs) use an LC tank. The inductor is a shielded, adjustable slug type in the 1–5 mH range. Shielding in the form of a metal can usually encloses the entire subassembly, and the designer should expect to employ such shielding in most applications requiring moderate or long distance operation.

Note that in Figures 7, 8, and 9 the bias supply to the receiving diode is heavily decoupled from the supply via an RC. Any noise present at this point directly impacts system noise and sensitivity. Bandwidth is also often limited at the upper end as an aid in overall noise performance as seen in Figures 7 and 9. These amplifiers use small capacitors (33 pF, 10 pF, 100 pF) to roll off frequencies above 100 kHz.

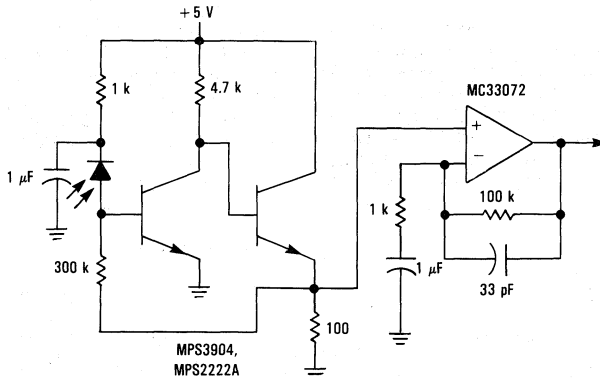

Figure 7. Simple Discrete Front End with Op Amp

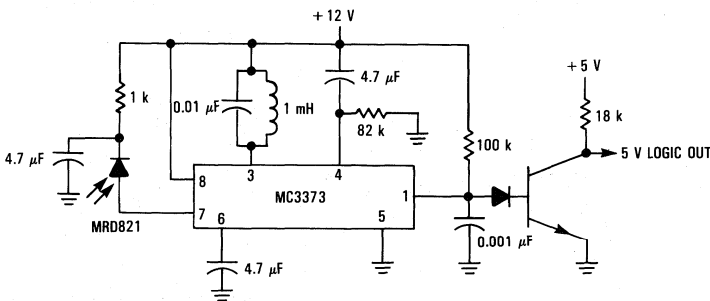

Figure 8. IR Receiver Using the Integrated MC3373

LONG DISTANCES

When the distance to be covered extends beyond 10 meters or so, other methods must be considered. The methods described below have resulted in ranges of 100 meters or more.

At the transmitting end, most of the options available center on increasing the power output. One way is to increase the IRED current, but this is subject to limits as previously discussed. Another solution is to use multiple diodes in series, often three. Note that this does not require additional supply current. Multiple diodes also provide one solution to those applications requiring less directionality, with the IREDs being slightly misaligned from one another.

The diodes can also be driven much harder, and produce proportionally higher instantaneous power, if they are pulsed with a very-short duty cycle. Currents of about an ampere are common, but for only a few microseconds and with a duty cycle of 5 percent or less. This also requires modified receiving techniques.

At the receiving end, most solutions center on increasing the aperture of the system such that simply more energy is gathered. Multiple receiver diodes can be connected in parallel,

adding their currents, with the additional possibility of reducing directionality if needed. Another technique is to add a lens, with the diode being placed at the focal point. In higher volume production, this is often molded into a front panel and is usually of the red filtering plastic mentioned earlier. Some systems make use of a flat Fresnel lens, being somewhat more difficult to mount but very effective. They can also be hidden behind a plastic panel.

Front-end amplifiers superior to the simple operational amplifier or discrete versions already mentioned may be found in these highest-performance situations. Such an amplifier is shown in Figure 9, where low-noise transistors are used in a circuit designed specifically for low-noise applications.

When pulsed sources are used, some encoding scheme is normally used to transmit the data. One common technique is to use a single pulse for one edge of a data bit, and two or more closely spaced pulses to signal the opposite edge. These are simply differentiated by some flip-flops and a small amount of timing circuitry. Other schemes use multiple pulses at close intervals to indicate one logic level, and a differing number to denote the other.

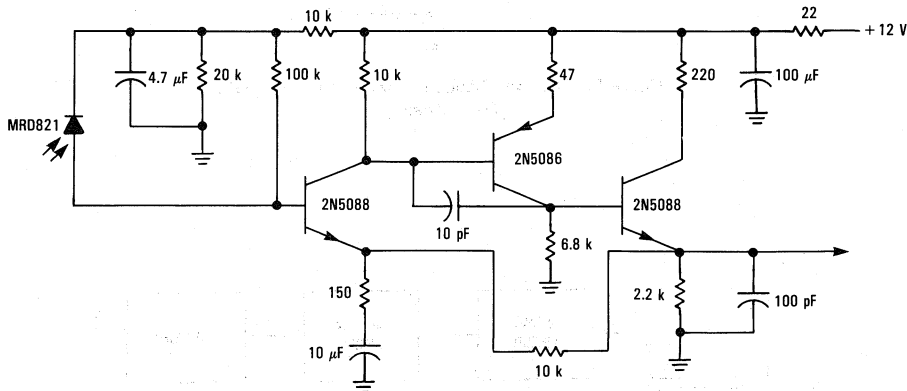

Figure 9. High-Performance Discrete Front-End Amplifier with Special Attention Paid to Noise

AN1016

One last option is sometimes seen at the end of the amplifier chain and used for the data detection. An analog phase-locked loop circuit can be used to pull a signal from noise and lock to it if appropriate. This lock signal is then used as the recovered data stream. One such device, shown in Figure 10, is the EXAR XR567, a small 8-pin tone decoder with both Type I and Type II phase detectors. It is capable of locking to analog signals in the 25 mV range, and makes/breaks lock at a rate sufficient for about 5,000 baud with 50–100 kHz inputs. The device can be operated up to about 500 kHz.

An advantage of the all-analog system is that the signal never needs to be amplified to the point of rail-to-rail limiting.

Thus, system-wide noise potential is decreased. Back-to-back diodes or similar methods are normally employed ahead of the loop input to hold the signal within a few hundred millivolts to protect against overdrive at close ranges.

CONCLUSION

As can be seen from the above discussion, IR links have become quite easy to implement. With the basic principles in mind, the designer should be able to adapt the techniques mentioned here to his specific system needs.

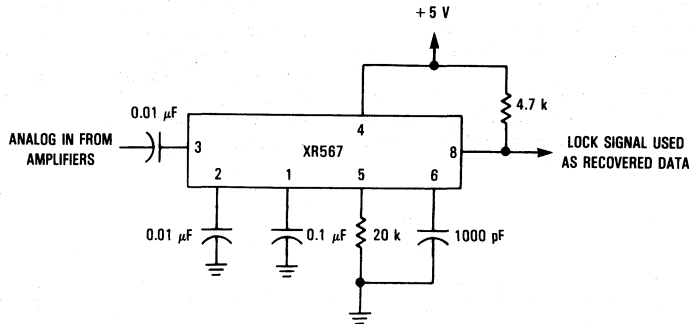

Figure 10. PLL Tone Decoder Used to Recover Data From Analog

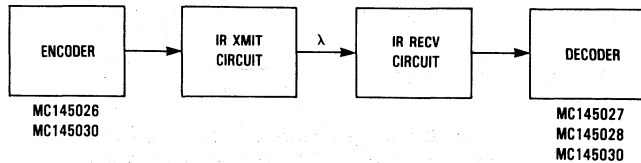

Figure 11. Utilizing Motorola's Encoders and Decoders

Optoisolators for Switching Power Supplies

Prepared by: Larry Hayes
 Warren Schultz
 Discrete Applications Engineering

In switching power supplies, optoisolators usually provide isolated feedback for the regulation loop. In this application, they do an excellent job of isolation, minimizing circuit complexity and reducing cost. The trade-offs are wide unit-to-unit variations in current transfer ratio, noise susceptibility, and long-term gain stability. But by using devices specifically designed for power supplies, these deficiencies can be minimized. A new series of devices, MOC8101 through MOC8104, combines an application-specific approach with technology improvements. The result is a significant performance increase in switching power supplies.

The biggest design challenge associated with optoisolators is the large unit-to-unit variation in current-transfer ratio (CTR). The statistical distribution of CTR within a given lot is characteristically large, and most standard devices are specified with only a minimum CTR, or at best, with a widely

spaced minimum and maximum. This is a first-order design issue because open-loop gain is directly proportional to the optoisolator's CTR.

Consider a typical 100-W flyback power supply. Total loop gain is found by multiplying the individual gains of each stage. For this power supply, the loop gain, A_v , is equal to the product of the individual gains of the error amplifier (A_e), comparator (A_c), power stage (A_{ps}), TL431 (g_m) and optoisolator (CTR). Looking at only the TL431 and optoisolator together, the gain is expressed as:

$$\left[\frac{(R_{11} \times R_{12})}{(R_{11} + R_{12})} \right] (gm)(CTR) \left[\frac{(R_5 \times R_6)}{(R_5 + R_6)} \right]$$

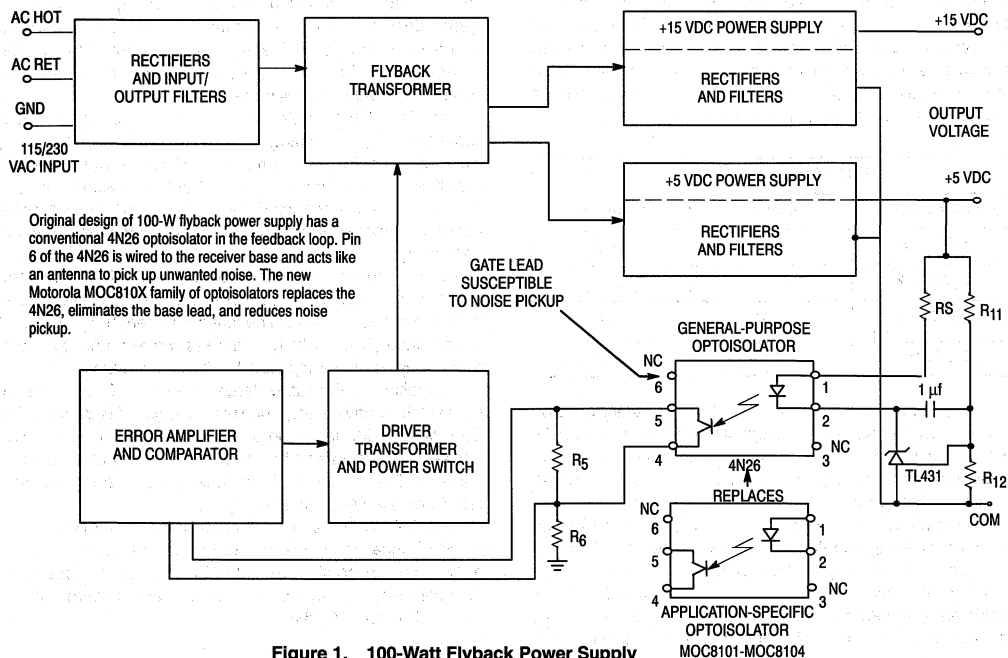

Noise is further reduced by coplanar die placement of the LED and phototransistor. This reduces the internal capacitance to 0.2 pF and minimizes the coupled noise injected by the optoisolator.

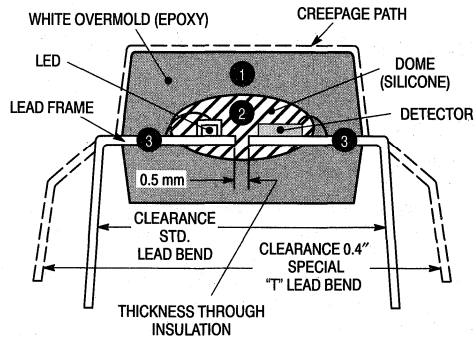

Figure 2. Coplanar Die Placement

Plugging in values for the resistors, g_m , CTR, and gains of the other amplifiers, the product yields a loop gain of 7,100 or 77 dB.

When minimum and maximum values for the optoisolator's CTR are factored into this calculation, the results are eye opening. For the widely used 4N26, the specified minimum is 0.2, and no maximum is guaranteed. The CTR can be as high as the upper limit of the supplier's statistical distribution; thus, values as high as 6.0 are common. Plugging this range back into the open-loop gain calculation results in a minimum of 3,500 (71 dB) and a maximum of 106,000 (101 dB). Because load regulation is proportional to open-loop gain, the same 30:1 variation follows through directly to output performance. In other words, a disturbance that produces a 1-mV change in the 101 dB supply will produce a 30 mV change in the 71 dB unit.

Motorola Optoisolator CTR		
Part Number	Minimum	Maximum
MOC8101	0.5	0.8
MOC8102	0.73	1.17
MOC8103	1.08	1.73
MOC8104	1.6	2.56

Current-transfer ratios (CTRs) for the new family of optoisolators have a guaranteed range of values, unlike the 4N26 that had a guaranteed minimum of 0.2, but no maximum. Designers can now better predict loop gains and overall control performance.

The new MOC8101 series devices, manufactured specifically for switching supplies, improves the situation by more than an order of magnitude. Using the MOC8101 as an example, the minimum CTR of 0.5 and maximum of 0.8 yields an open-loop gain that varies only from 8,850 (79 dB) to 14,200 (83 dB). With this tight range, the nominal gain

can be adjusted upward appreciably without exceeding the 100 dB maximum limit required for stability. The result is better regulation, additional gain margin, or a combination of the two.

General-purpose optoisolators, such as 4N26, use a 5-lead configuration. Here, the optotransistor's base is pinned out to provide flexibility for the general-purpose user. However, in switching supplies, the internal chip-to-pin wire and the external lead together act as an antenna to pick up switching noise, which is introduced into the feedback loop. To minimize this problem, noise-decoupling networks are often added from base to emitter. Another approach is to cut off the external pin 6 (base) lead, which provides a partial improvement, but still leaves the internal chip-to-pin connected inside the package.

The MOC8101 series optoisolators minimize noise susceptibility by eliminating the base connection. Only anode, cathode, collector, and emitter connections are provided, resulting in a four-terminal device that is housed in a six-pin DIP with two unconnected pins. The need for the extra passive components is eliminated, along with added cost and complexity.

Noise is further minimized by coplanar die placement, which puts the LED and phototransistor end to end, rather than one above the other. The result is a mere 0.2 pF coupled capacitance (C_{iso}), which minimizes the amount of capacitively coupled noise injected by the optoisolator.

In addition to the rather large unit-to-unit CTR variation, optoisolators have been known to exhibit CTR degradation over time. Fortunately, improvements in gallium-arsenide (GaAs) processing and handling now virtually eliminate this concern. These recent improvements have been incorporated into the MOC8101 family.

The MOC8101 series devices have remarkable gain stability. Under the strongly accelerated LED drive condition of $I_F = 50$ mA continuous, MOC8101 series devices have now completed a total of 5,000 h of operation with a mean gain shift of only 0.7%.

VDE Circuit Board Layout Design Rules

The most demanding and stringent safety requirements are on interfaces between a safety low-voltage circuit [SELV] and a hazardous voltage (240 V power line). The requirements for creepage path and clearance dimensioning are different for each individual equipment norm and also depend on the isolation group and safety class of the equipment and the circuit board's resistance to tracking. Isolation materials are classified for their resistance to tracking creepage current stability from KB 100 to $KB \leq 600$ (see VDE 303). On circuit board materials with a low KB value, the creepage path distance requirements are higher than for materials with a high KB value. In the following examples we therefore show creepage path dimensions for KB 100, the lowest value which is easily met by most circuit board materials.

The least stringent requirements on optocouplers, as well as printboard layouts, are within and in between SELV or ELV loops or circuits. (ELV = Electrical Low Voltage which does not meet the safety low voltage requirements.)

In studying the individual equipment norms, the designer will discover that optocouplers are not mentioned in most of these norms. He has to use the requirements for transformers or potted components instead.

Spacing requirements between two live tracks on a PC board within a low or high voltage loop (circuit) should generally meet the VDE requirements for minimum clearance and creepage path dimensions. If they do not, the circuit has to show some sort of current limiting (fuse, high-impedance, etc.) which prevents fire hazard due to an eventual short or sparkover between the two tracks. The VDE testing institute will conduct, in this case, a shorting test and a tracking test (arcing). See VDE 804. Classical cases are rectifiers, thyristors and high-voltage transistors which, sometimes due to their close pinout, might not meet the VDE equipment requirements at a certain voltage.

PRINTED CIRCUIT BOARD LAYOUT FOR SELV-POWER INTERFACES

The circuit board layout examples shown here are dimensioned so that they provide a safe electrical isolation between metal parts carrying line voltage (called Power Interface) and conductors connected to a SELV circuit.

The required thickness through insulation for the optocoupler can be found in the individual VDE equipment norms. (See examples for safety applications, Table 1.)

Many Class I equipment norms permit the use of parts (modules, PC boards) which meet the Safety Class II dimension and isolation requirements. This enables the designer to take advantage of the less complex and space demanding design of the Class II PC board layout also in Class I classified equipment.

Optocoupler Mounting on PC Boards for Safety Class I

SELV transformers for Class I equipment have a Faraday shield which is connected to earth ground between primary and secondary windings. This is **not** applicable to optocouplers, but creepage path and clearance requirements from safety Class II can be applied. Class I also demands an earth ground track on the circuit board between SELV — and power circuit. Applying the Class I rules, this earth ground track should be between the coupler input and output. However, this cannot be done without violating the minimum creepage path and clear-

Figure 1.

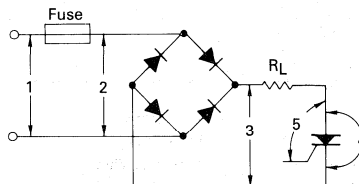

- 1 — Clearance and creepage path **must** meet min requirements*
 - 2 — Current limited due to fuse
 - 3, 4 — Current limited due to R_L and fuse
 - 5 — Current limited due to I_{GT} , R_L and fuse
- 2, 3, 4, 5 — Clearance and creepage path may be smaller than VDE min requirements but **must** meet fire hazard requirements due to short and arcing between the tracks. There shall be no flames or explosion during the test.

Figure 2.

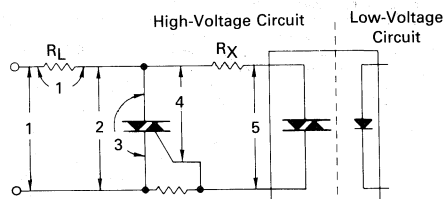

- 1 Clearance and creepage path **must** meet min requirements*
- 2 Current limited due to R_L
- 3 Current limited due to R_L
- 4 Current limited due to I_{GT}
- 5 Current limited due to I_{GT} and R_X

*See Table 1 and Appendix Table 2 and 3 for minimum spacings and voltage requirements.

ance requirements. A possible solution is shown on Figure 9 and Figure 10.

The earth ground track itself has to show a minimum distance to the equipment body (i.e., frame, circuit board enclosure) or to any inactive, active or hazardous track on the circuit board. According to many VDE equipment norms, this creepage path distance for 250 V Max is 4 mm. A mechanically unsecured circuit board which can be plugged in and out without a tool and is electrically connected through a standard PC board connector, has to show an isolation of the earth ground track to Class II, which is 8 mm. This is because a standard PC connector, as shown in Figure 9, does not guarantee earthing contact **before** there is termination of the life 220 V tracks on the circuit board when plugged in. Another reason for increased spacing is when the circuit board metal enclosure is not securely earth grounded. This is the case when the connection is done with the PC module mounting screws through lacquer or oxide layers to a grounded rack or frame. (See Figure 10.) PC board designs per Figures 9 and 10 account for these possibilities and, therefore, show dimensions M, N and A, B and D as 8 mm instead of 4 mm.

Table 1. Examples for Safety Applications for Motorola VDE Approved Optoisolators

Standard (2)		Equipment	Requirements for reinforced (double) or safe insulation for equipment with an operating voltage up to 250 Vrms (line voltage to ELV or SELV interfaces)				
VDE	DIN IEC		Creepage	Clearance (1)	Isolation Barrier	Dielectric Strength	Isolation Resistance
			[mm]	[mm]	[mm]	[kV RMS]	[Ω]
0806	950	Office Machines	8.0	8.0	0.5	3.75	7×10^6
0805	950	Data Processing	8.0	8.0	—	3.75	7×10^6
0804	—	Telecommunication	8.0	8.0	—	2.5	2×10^6
0860	65	Electrical Household	6.0	6.0	0.4	3.0 (10)*	4×10^6
0113	204	Industrial Controls	8.0	8.0	—	2.5	1×10^6
0160	—	Power Installations with Electronic Equipment	8.0	8.0	—	2.7	1×10^6
0832	—	Traffic Light Controls	8.0	8.0	—	2.5	4×10^6
0883	—	Alarm Systems	8.0	8.0	—	2.5	2×10^6
0831	—	Electrical Signal System for Railroads	8.0	8.0	—	2.0	2×10^6
0110	—	General Std. for Electrical Equipment	8.0	8.0	—	2.0	—
0883	—	Optoisolator Component Standard (obsolete 12/31/91)	8.5	8.3 (10) (1)	0.5	3.75 (10)*	10×10^{11}
0884(4)	—	Optoisolator Component Standard (replaces VDE0883)	>7.5	>7.5	0.5	—	10×10^{12}
VDE Rating for Motorola 6-pin DIP Optoisolators							

All Motorola 6-pin DIP Optoisolators meet or exceed the requirements of above listed VDE and DIN IEC Standards.

* Impulse discharge withstand voltage.

(1) To satisfy 8.0 mm creepage path on a PC board Motorola offers a special lead bend of 0.4 inch on all 6-pin dual-in-line optoisolators. Order by attaching "T" to the end of the Motorola part number.

(2) VDE standards (translated into English language) and IEC standards can be ordered from the American National Standard Institute ANSI 1430 Broadway, N. Y., N. Y. 10018, Sales Department 212-642-4900.

(3) Creepage path distances are measured from lead to lead across the top, bottom and ends of the package body.

(4) VDE 0884 testing is an option; the suffix letter "V" must be added to the standard number.

Figure 3. Optocoupler Mounting on PC Boards for Safety Class II with Creepage Path and Clearance

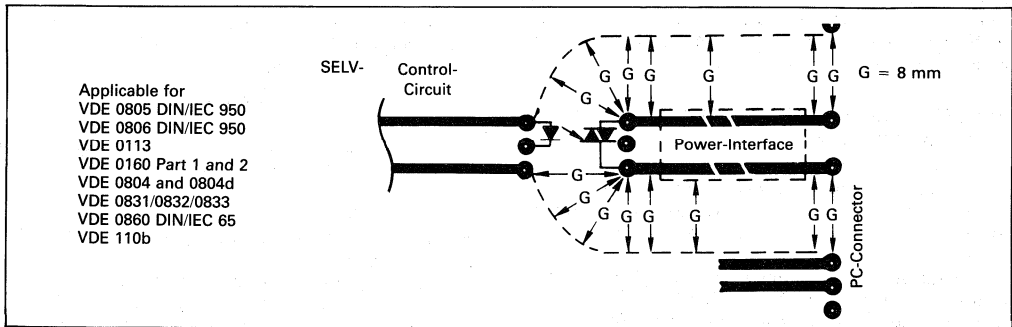
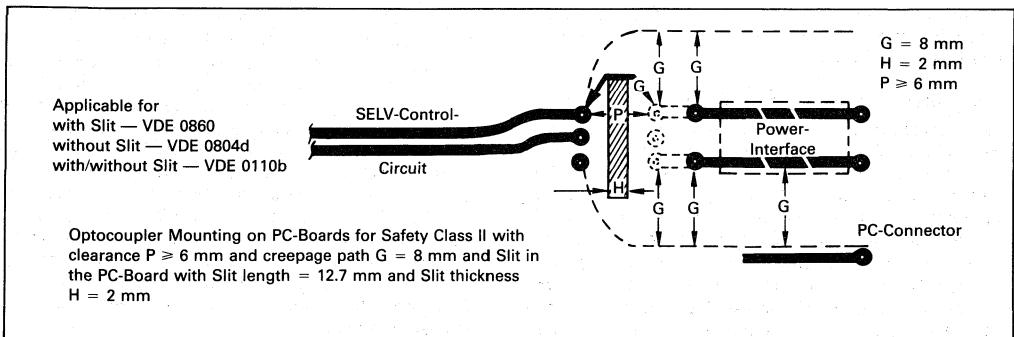
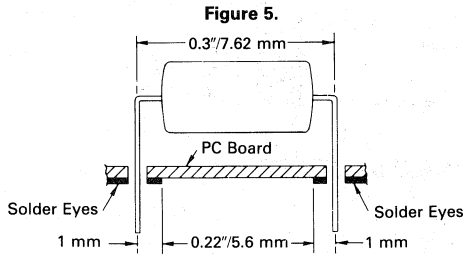

Figure 4. Optocoupler Mounting on PC Boards for Safety Class II with Clearance



COUPLER MOUNTING ON A CIRCUIT BOARD
Clearance and Creepage Path Between Input and Output for Optocouplers on a PC Board



Input/Output Leads — $L = 0.3"/7.62 \text{ mm}$
 Clearance Limited Due to PC Board
 Solder Eyes — $0.22"/5.6 \text{ mm}$
 Creepage Path on PC Board — $0.22"/5.6 \text{ mm}$

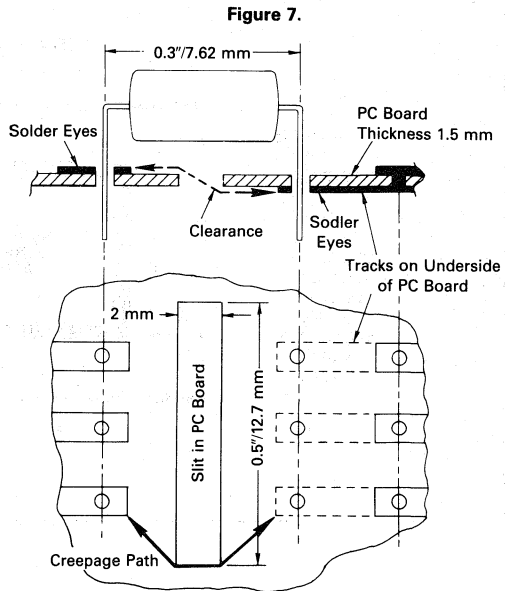

If a clearance of $0.23"/6 \text{ mm}$ and a creepage path of minimum 8 mm is required, this is a possible solution.

Slit — $0.5"/12.7 \text{ mm}$ long, 2 mm wide
 PC Board Thickness — 1.5 mm
 Clearance — 6 mm Min
 Creepage Path — 8 mm Min

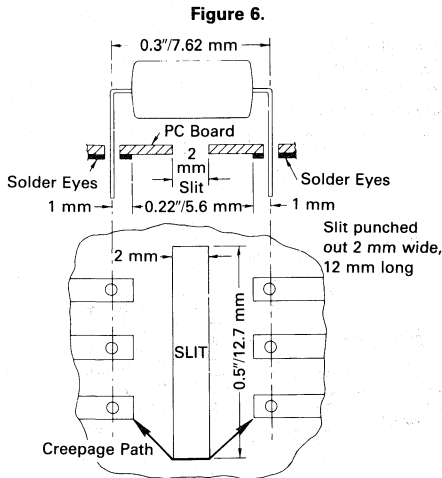

VDE equipment norms demanding longer creepage path than $0.22"/5.6 \text{ mm}$ can be accomplished by a slit in the PC board between the coupler input and output solder eyes of 2 mm width.

Input/Output Leads — $L = 0.3"/7.62 \text{ mm}$
 Clearance on PC Boards — $0.22"/5.6 \text{ mm}$ Min
 Creepage Path on PC Board — 0.318 mm Min

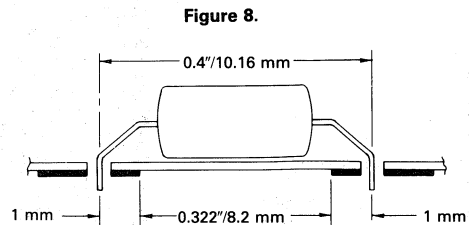

Where the equipment norms demand a clearance and creepage path of 8 mm Min, the coupler input and output leads should be bent to $0.4"/10.16 \text{ mm}$ and the printboard layout should be as shown.

Safety Coupler Mounting with Spacing — $L = 0.4"/10.16 \text{ mm}$
 Clearance on PC Board — $0.322"/8.2 \text{ mm}$
 Creepage Path on PC Board — $0.322"/8.2 \text{ mm}$

All Motorola 6-pin dual-in-line optoisolators are available in 0.400" lead form. Attach "T" to any Motorola 6-pin dual-in-line part number, for wide-spaced 0.400" lead form.

Figure 9. Optocoupler Mounting on PC Board According to Safety Class I with Only One PC Board Plug Connection

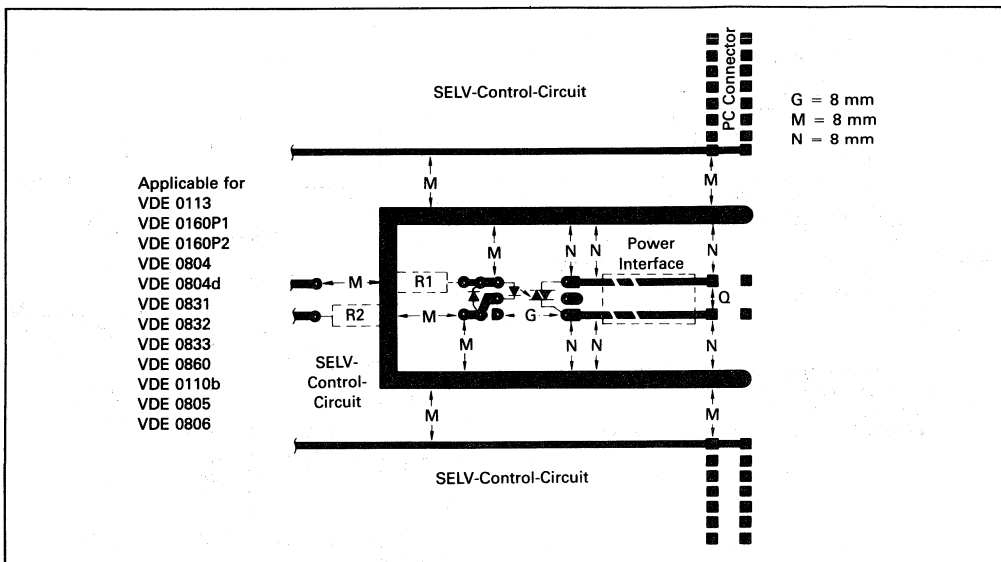
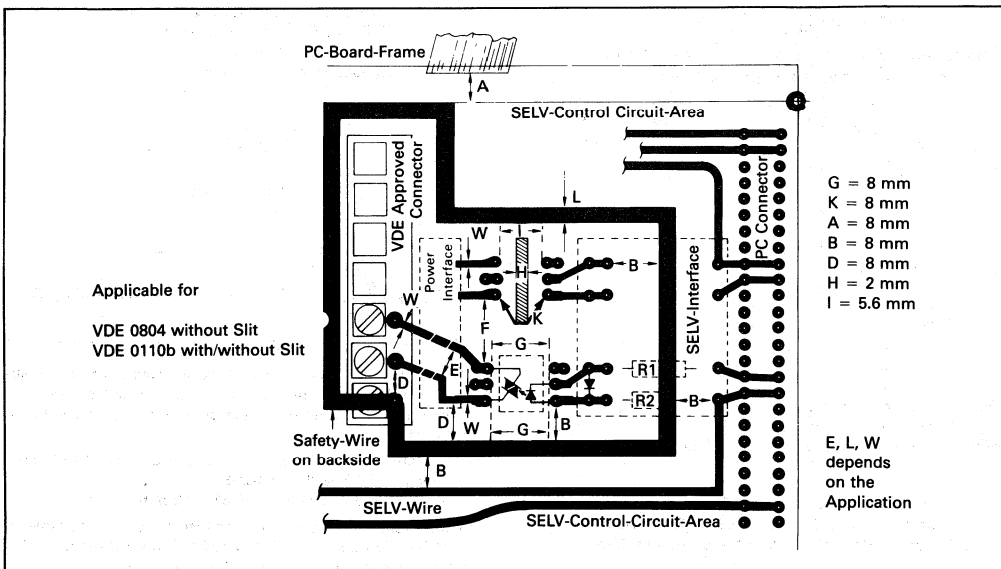

Figure 10. Optocoupler Mounting on PC Board According to Safety Class I with One Plug-Connection for the SELV-Control Circuit and One Screw-Connection for the Power-Interface



DEFINITION OF TERMS

The following paragraphs define terms used by the regulatory and international standard initiators. A separate discussion is given for:

1. Creepage and Clearance
2. Voltage
3. Insulations
4. Circuits
5. Equipment

1. CREEPAGE AND CLEARANCE

ISOLATION CREEPAGE PATH

Denotes the shortest path between two conductive parts measured along the surface of the insulation, i.e., on the optocouplers, it is the shortest distance on the surface of the package between the input and output leads. On the circuit board in which the coupler is mounted, it is the shortest distance across the surface on the board between the solder eyes of the coupler input/output leads. Coupler and circuit board creepage path have to meet the minimum specified distances for the individual VDE equipment norms.

Figure 11.

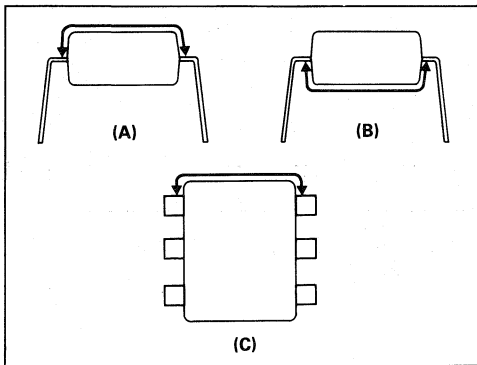

CLEARANCE

Denotes the shortest distance between two conductive parts or between a conductive part and the bonding surface of the equipment, measured through air.

Figure 12.

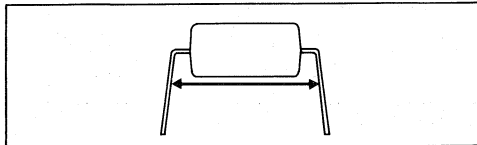

2. VOLTAGES

HAZARDOUS VOLTAGE: A voltage exceeding 42.4 V peak or dc, existing in a circuit which does not meet the requirements for a limited current circuit.

WORKING VOLTAGE shall be the voltage which exists across the insulation under normal working conditions. Where the rms value is used, a sinusoidal ac waveform shall be assumed. Where the dc value is used, the peak value of any superimposed ripple shall be considered.

EXTRA-LOW VOLTAGE (ELV): A voltage between conductors or between a conductor and earth not exceeding 42.4 V peak or dc, existing in a secondary circuit which is separated from hazardous voltages by at least basic insulation, but which does not meet the requirements for a SELV circuit nor those for a limited current circuit.

ISOLATION WITHSTAND VOLTAGE: An ac or dc test voltage insulation has to withstand without breakdown or damage. It should not be confused with working or operating voltage.

ISOLATION SURGE VOLTAGE: A positive or negative transient voltage of defined energy and rise and fall times which the insulation has to withstand without breakdown or damage.

3. INSULATIONS

INSULATION, OPERATIONAL (functional): Insulation which is necessary for the correct operation of the equipment.

- Between parts of different potential.
- Between ELV or SELV circuits and earthed conductive parts.

INSULATION, BASIC: Insulation to provide basic protection against electric shock.

- Between a part at hazardous voltage and an earthed conductive part.
- Between a part at hazardous voltage and a SELV circuit which relies on being earthed for its integrity.
- Between a primary power conductor and the earthed screen or core of a primary power transformer.
- As an element of double insulation.

INSULATION, SUPPLEMENTARY: Independent insulation applied in addition to basic insulation in order to ensure protection against electric shock in the event of a failure of the basic insulation.

- Between an accessible conductive part and a part which could assume a hazardous voltage in the event of a failure of basic insulation.

- Between the outer surface of handles, knobs, grips and the like, and their shafts unless earthed.

- Between a floating non-SELV secondary circuit and an unearthed conductive part of the body.

INSULATION, DOUBLE: Insulation comprising both basic insulation and supplementary insulation.

INSULATION, REINFORCED: A single insulation system which provides a degree of protection against electric shock equivalent to double insulation under the conditions specified in the standard.

SAFE ELECTRICAL ISOLATION: Denotes an insulation system isolating a hazardous voltage circuit from a SELV circuit such that an insulation breakdown either is unlikely or does not cause a hazardous condition on the SELV circuit.

- Between an unearthed accessible conductive part or a floating SELV circuit, and a primary circuit.

4. CIRCUITS

PRIMARY CIRCUIT: An internal circuit which is directly connected to the external supply mains or other equivalent source (such as motor-alternator set) which supplies the electric power. It includes the primary windings of transformers, motors, other loading devices and the means of connection to the supply mains.

SECONDARY CIRCUIT: A circuit which has no direct connection to primary power and derives its power from a transformer, converter or equivalent isolation device situated within the equipment.

SAFETY EXTRA-LOW VOLTAGE (SELV) CIRCUIT: A circuit which is so designed and protected that under normal and single fault conditions the voltage between any two accessible parts, one of which may be the body or earth, does not exceed a safe value.

5. EQUIPMENTS

CLASS I EQUIPMENT: denotes equipment in which

protection against electric shock does not rely on basic insulation only, but which includes an additional safety precaution in that operator-accessible conductive parts are connected to the protective earthing conductor in the fixed wiring of the installation in such a way that the operator-accessible conductive parts cannot become hazardous in the event of a failure of the basic insulation.

Class I equipment may have parts with double insulation or reinforced insulation, or parts operating at safety extra-low voltage.

CLASS II EQUIPMENT denotes equipment in which protection against electric shock does not rely on basic insulation only, but in which additional safety precautions, such as double insulation or reinforced insulation, are provided, there being no provision for protective earthing or reliance upon installation conditions.

CLASS III EQUIPMENT: Equipment in which protection against electric shock relies upon supply from SELV circuits and in which hazardous voltages are not generated.

Table 2. Minimum Rating Requirements for a Working Voltage up to 250 Vrms

Insulation	Creepage [mm]	Clearance [mm]	Isolation Barrier [mm]	Diel. Strength [kV ac rms]	Isolation Resistance Ω
Operational	2.5	3	—	0.5	—
Basic	3	4	—	1.5	2 10 ⁶
Supplementary	4	4	— to 2	2.5	5 10 ⁶
Reinforced	8	8	— to 2*	2.5 to 3.75*	7 10 ⁶

*See Table 1 for details.

Table 3. Electrical Interfaces and Required Insulation

Case	Bare Metal Parts not Touchable		Bare Metal Parts Touchable	
	Primary Circuit (Line Voltage)	ELV Secondary Circuit ≤ 42.4 V	SELV Secondary Circuit ≤ 42.4 V	Earth Ground
1.				
2.				
3.				
4.				
5.				
6.				
7.				
Class II Equipment				
Class I Equipment				

B = Basic Insulation F = Functional (Operational Insulation)
 R = Reinforced or Safe Insulation S = Supplementary Insulation

Application Note Abstracts

(Application Notes are available upon request.)

AN1126 Evaluation Systems for Remote Control Devices on an Infrared Link

The discussion provides information for constructing the basic building blocks for evaluation of both the IR transmitter/receiver and the most popular remote control devices. Schematics and single-sided PC board layouts are presented which enable the designer to put together a basic control link and evaluate its suitability in terms of data rate, effective distance, error rate, and cost.

AN1078 New Components Simplify Brush DC Motor Drives

Brush motor drive design is simplified by combining multiple power MOSFETs, a new MOS turn-off device and gain stable opto level shifters. The discussion describes circuits which can be combined to make practical drive circuits which control speed in both directions and operate from a single power supply.

AN703 Designing Digitally-Controlled Power Supplies

Two design approaches are discussed: basic low voltage supply using an inexpensive MC1723 voltage regulator and a high current, high voltage supply using the MC1466 floating regulator with optoelectronic isolation. Various circuit options are shown to allow the designer maximum flexibility in any application.

AN575A Variable Speed Control System for Induction Motors

This note describes a method of controlling the speed of standard induction motors above and below their rated speeds. A unique variable frequency drive system is used to maintain the rated output torque at speeds below the nameplate rating.

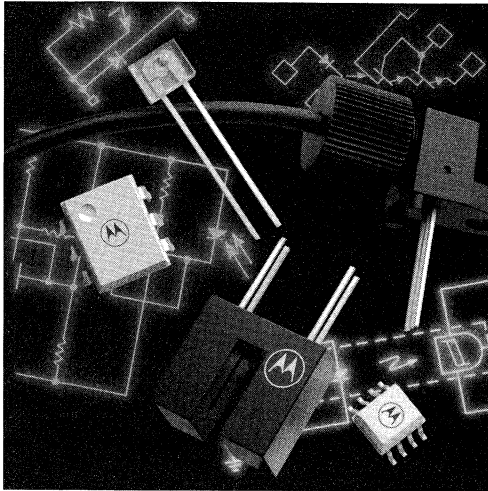

Section Twelve

Tape and Reel Specifications and Surface Mount Package Information

SO-8 Tape and Reel Specifications	12-2
6-Pin Tape and Reel Specifications	12-3
Emitters/Detectors Tape and Reel Specifications	12-5
Surface Mount Package Information	12-8

SO-8 Tape and Reel Specifications

Motorola has now added the convenience of Tape and Reel packaging for our growing family of Opto products. Two reel sizes are available for all but the largest types to support the requirements of both first and second generation pick-and-

place equipment. The packaging fully conforms to the latest EIA-481 specification. The antistatic embossed tape provides a secure cavity, sealed with a peel-back cover tape.

MECHANICAL POLARIZATION

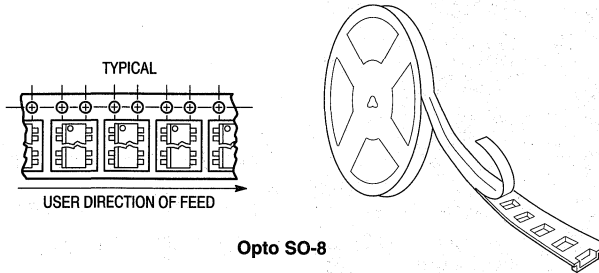

Opto SO-8

Package	Tape Width (mm)	Device ¹ per Reel	Reel Size (inch)	Device Suffix
Opto SO-8	12	500	7	R1
Opto SO-8	12	2,500	13	R2

(1) Minimum order quantity is one reel. Distributors/OEM customers may break lots or reels at their option; however, broken reels may not be returned.

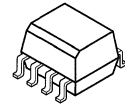
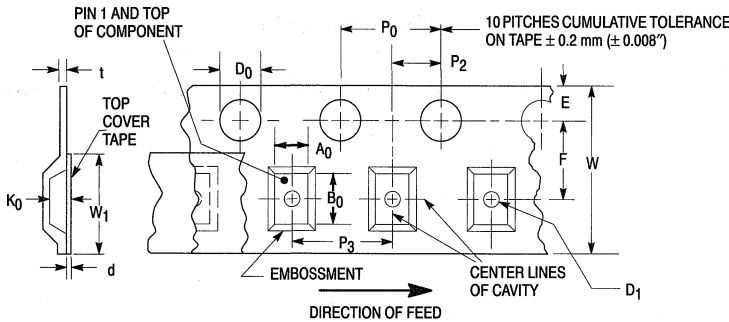

CASE 846-01
SO-8 DEVICES

Description	Symbol	Dimensions in Inches (mm) SOIC8	Notes
Tape width	W	.472 ± .012 (12 ± .3)	
Carrier tape thickness	t	.012 (0.3) max.	
Pitch of sprocket holes	P ₀	.157 ± .004 (4 ± 0.1)	Cummulative pitch error +0.2 mm/10 pitches
Diameter of sprocket holes	D ₀	.059 (1.5) min.	
Distance of sprocket holes	E	.069 ± .004 (1.75 ± 0.1)	
Distance of compartment	F	.217 ± .002 (5.5 ± .005)	Center hole to center compartment
	P ₂	.079 ± .002 (2 ± 0.05)	
Distance compartment to compartment	P ₃	.157 (4)	
Compartment	K ₀	.140 (3.5)	
	A ₀	.252 (6.4)	
	B ₀	.205 (5.2)	
Hole in compartment	D ₁	.054 (1.5)	
Width of fixing tape	W ₁	.325 (8.3) tape	The fixing tape shall not cover the sprocket holes, nor protrude beyond the carrier tape so not to exceed max. tape width
	d	.004 (0.1) max.	
Device tilt in the compartment		15° max.	
Minimum bending radius		1.18 (30)	

12

6-Pin Tape and Reel Specifications

All 6-Pin surface mount devices are available in Tape & Reel format.

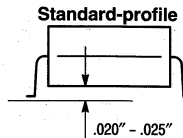
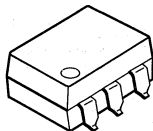
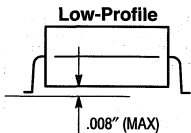

Package	Tape Width (mm)	Device ¹ per Reel	Reel Size (inch)	Device Suffix
6-Pin Optoisolators	24	1,000	13	R2

(1) Minimum order quantity is one reel. Distributors/OEM customers may break lots or reels at their option; however, broken reels may not be returned.

Add the following suffixes to the standard DIP-6 part number to obtain the option of your choice:

Low-profile surface mount Tape & Reel option = "FR2"

Standard-profile surface mount Tape & Reel option = "SR2"

EMBOSED TAPE AND REEL DATA FOR OPTO CARRIER TAPE SPECIFICATIONS

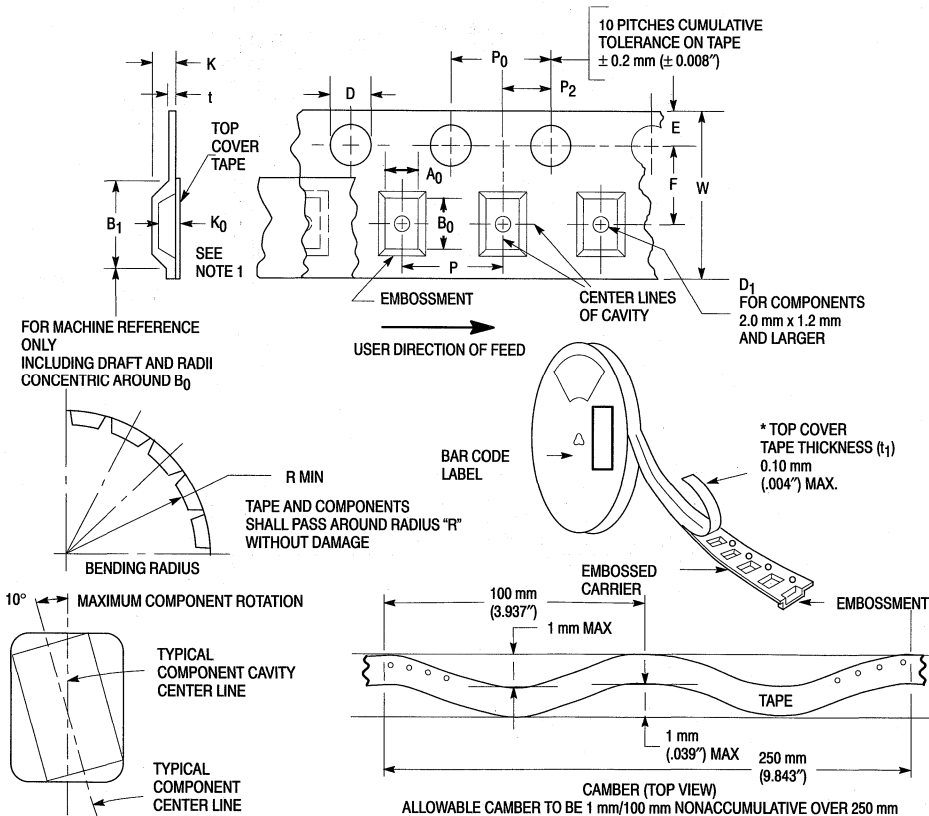

6-PIN TAPE AND REEL SPECIFICATIONS (continued)

DIMENSIONS

Tape Size	B ₁ Max	D	D ₁	E	F	K	P	P ₀	P ₂	R Min	T Max	W Max
24 mm	20.1 mm (.791")	1.5 ± 0.1 mm - 0.0 (.059 ± .004" - 0.0)	1.5 mm Min (.060")	1.75 ± 0.1 mm (.069 ± .004")	11.5 ± 0.1 mm (.453 ± .004")	11.9 mm Max (.468")	16.0 ± .01 mm (.63 ± .004")	4.0 ± 0.1 mm (.157 ± .004")	2.0 ± 0.1 mm (.079 ± .002")	30 mm (1.18")	0.6 mm (.024")	24.3 mm (.957")

Metric dimensions govern — English are in parentheses for reference only.

NOTE 1: A₀, B₀, and K₀ are determined by component size. The clearance between the components and the cavity must be within .05 mm min. to .50 mm max., the component cannot rotate more than 10° within the determined cavity.

EMBOSSED TAPE AND REEL DATA FOR OPTO

Reel Dimensions

Metric Dimensions Govern — English are in parentheses for reference only

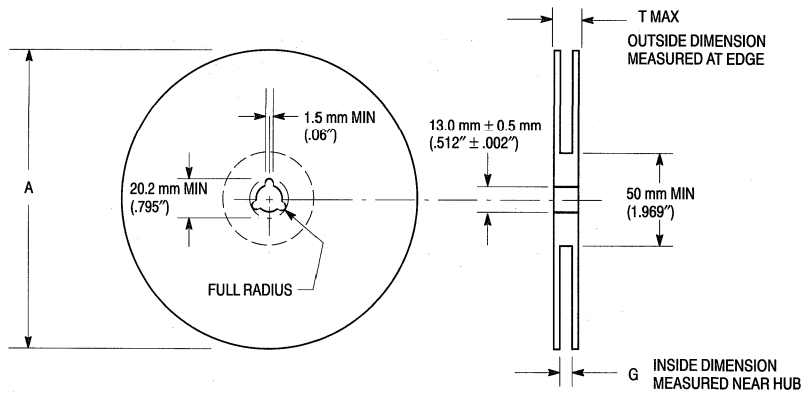

Size	A Max	G	T Max
24 mm	360 mm (14.173")	24.4 mm + 2.0 mm, -0.0 (.961" + .070", -0.00)	30.4 mm (1.197")

Emitters/Detectors Tape and Reel Specifications

TO-92 EIA, IEC, EIAJ Radial Tape in Fan Fold Box or On Reel

Radial tape in fan fold box or on reel of the reliable TO-92 package are the best methods of capturing devices for automatic insertion in printed circuit boards. These methods of taping are compatible with various equipment for active and passive component insertion.

- Available in Fan Fold Box
- Available on 365 mm Reels
- Accommodates All Standard Inserters
- Allows Flexible Circuit Board Layout
- 2.5 mm Pin Spacing for Soldering
- EIA-468, IEC 286-2, EIAJ RC1008B

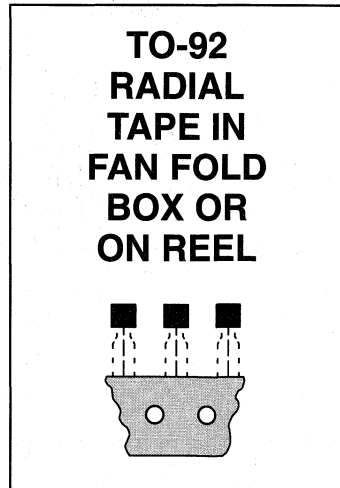

Ordering Notes:

When ordering radial tape in fan fold box or on reel, specify the style per Figures 3 through 6. Add the suffix "RLR" and "Style" to the device title, i.e. MPS3904RLRA. This will be a standard MPS3904 radial taped and supplied on a reel per Figure 3.

Fan Fold Box Information — Minimum order quantity 1 Box/\$200LL.
Order in increments of 2000.

Reel Information — Minimum order quantity 1 Reel/\$200LL.
Order in increments of 2000.

US/European Suffix Conversions

US	EUROPE
RLRA	RL
RLRE	RL1
RLRM	ZL1

Package	Tape Width (mm)	Device ¹ per Reel	Reel Size (inch)	Device Suffix
Emitters/Detectors	N/A	2,000	N/A	RLRE

(1) Minimum order quantity is one reel. Distributors/OEM customers may break lots or reels at their option; however, broken reels may not be returned.

TO-92 EIA RADIAL TAPE IN FAN FOLD BOX OR ON REEL

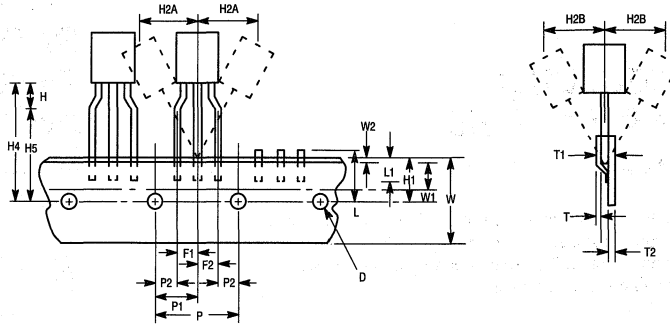

Figure 1. Device Positioning on Tape

Symbol	Item	Specification			
		Inches		Millimeter	
		Min	Max	Min	Max
D	Tape Feedhole Diameter	0.1496	0.1653	3.8	4.2
D2	Component Lead Thickness Dimension	0.015	0.020	0.38	0.51
F1, F2	Component Lead Pitch	0.0945	0.110	2.4	2.8
H	Bottom of Component to Seating Plane	.059	.156	1.5	4.0
H1	Feedhole Location	0.3346	0.3741	8.5	9.5
H2A	Deflection Left or Right	0	0.039	0	1.0
H2B	Deflection Front or Rear	0	0.051	0	1.0
H4	Feedhole to Bottom of Component	0.7086	0.768	18	19.5
H5	Feedhole to Seating Plane	0.610	0.649	15.5	16.5
L	Defective Unit Clipped Dimension	0.3346	0.433	8.5	11
L1	Lead Wire Enclosure	0.09842	—	2.5	—
P	Feedhole Pitch	0.4921	0.5079	12.5	12.9
P1	Feedhole Center to Center Lead	0.2342	0.2658	5.95	6.75
P2	First Lead Spacing Dimension	0.1397	0.1556	3.55	3.95
T	Adhesive Tape Thickness	0.06	0.08	0.15	0.20
T1	Overall Taped Package Thickness	—	0.0567	—	1.44
T2	Carrier Strip Thickness	0.014	0.027	0.35	0.65
W	Carrier Strip Width	0.6889	0.7481	17.5	19
W1	Adhesive Tape Width	0.2165	0.2841	5.5	6.3
W2	Adhesive Tape Position	.0059	0.01968	.15	0.5

NOTES:

1. Maximum alignment deviation between leads not to be greater than 0.2 mm.
2. Defective components shall be clipped from the carrier tape such that the remaining protrusion (L) does not exceed a maximum of 11 mm.
3. Component lead to tape adhesion must meet the pull test requirements.
4. Maximum non-cumulative variation between tape feed holes shall not exceed 1 mm in 20 pitches.
5. Holddown tape not to extend beyond the edge(s) of carrier tape and there shall be no exposure of adhesive.
6. No more than 1 consecutive missing component is permitted.
7. A tape trailer and leader, having at least three feed holes is required before the first and after the last component.
8. Splices will not interfere with the sprocket feed holes.

EMITTERS/DETECTORS TAPE AND REEL SPECIFICATIONS (continued)

TO-92 EIA RADIAL TAPE IN FAN FOLD BOX OR ON REEL

REEL STYLES

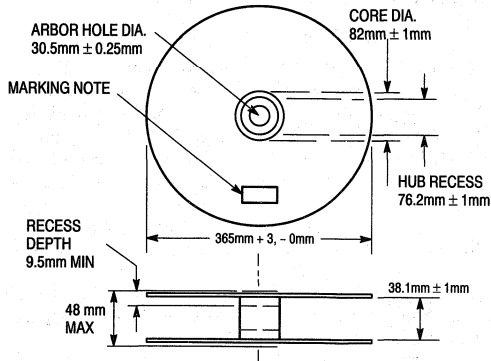

Material used must not cause deterioration of components or degrade lead solderability

Figure 2. Reel Specifications

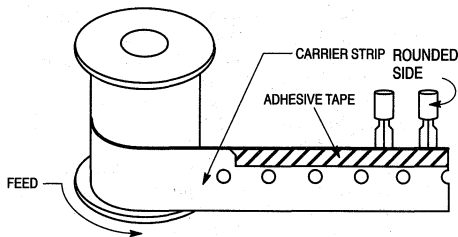

Rounded side of transistor and adhesive tape visible.

Figure 3. Style A

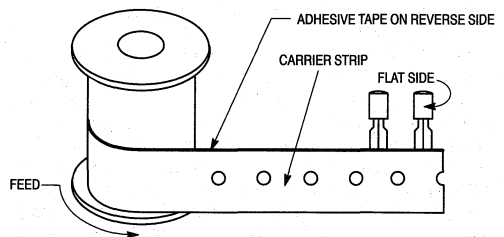

Flat side of transistor and carrier strip visible (adhesive tape on reverse side).

Figure 4. Style B

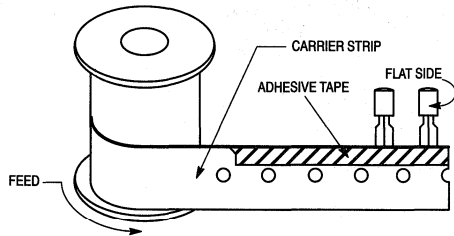

Flat side of transistor and adhesive tape visible.

Figure 5. Style E

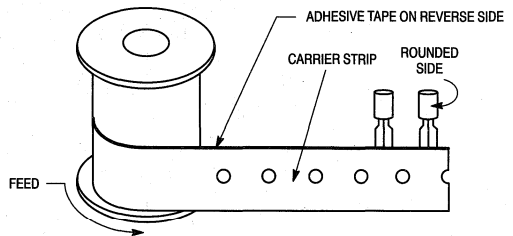

Rounded side of transistor and carrier strip visible (adhesive tape on reverse side).

Figure 6. Style F

Surface Mount Package Information

SOLDER STENCIL GUIDELINES

Prior to placing surface mount components onto a printed circuit board, solder paste must be applied to the pads. A solder stencil is required to screen the optimum amount of solder paste onto the footprint. The stencil is made of brass or

stainless steel with a typical thickness of 0.008 inches. The stencil opening size for the SOIC-8 package should be the same as the pad size on the printed circuit board, i.e., a 1:1 registration.

SOLDERING PRECAUTIONS

The melting temperature of solder is higher than the rated temperature of the device. When the entire device is heated to a high temperature, failure to complete soldering within a short time could result in device failure. Therefore, the following items should always be observed in order to minimize the thermal stress to which the devices are subjected.

- Always preheat the device.
- The delta temperature between the preheat and soldering should be 100°C or less.*
- When preheating and soldering, the temperature of the leads and the case must not exceed the maximum temperature ratings as shown on the data sheet. When using infrared heating with the reflow soldering method, the difference shall be a maximum of 10°C.
- The soldering temperature and time shall not exceed 260°C for more than 5 seconds.

- When shifting from preheating to soldering, the maximum temperature gradient shall be 5°C or less.
- After soldering has been completed, the device should be allowed to cool naturally for at least three minutes. Gradual cooling should be used as the use of forced cooling will increase the temperature gradient and result in latent failure due to mechanical stress.
- Mechanical stress or shock should not be applied during cooling

* Soldering a device without preheating can cause excessive thermal shock and stress which can result in damage to the device.

TYPICAL SOLDER HEATING PROFILE

For any given circuit board, there will be a group of control settings that will give the desired heat pattern. The operator must set temperatures for several heating zones, and a figure for belt speed. Taken together, these control settings make up a heating "profile" for that particular circuit board. On machines controlled by a computer, the computer remembers these profiles from one operating session to the next. Figure 1 shows a typical heating profile for use when soldering a surface mount device to a printed circuit board. This profile will vary among soldering systems but it is a good starting point. Factors that can affect the profile include the type of soldering system in use, density and types of components on the board, type of solder used, and the type of board or substrate material being used. This profile shows temperature versus time. The

line on the graph shows the actual temperature that might be experienced on the surface of a test board at or near a central solder joint. The two profiles are based on a high density and a low density board. The Vitronics SMD310 convection/infrared reflow soldering system was used to generate this profile. The type of solder used was 62/36/2 Tin Lead Silver with a melting point between 177–189°C. When this type of furnace is used for solder reflow work, the circuit boards and solder joints tend to heat first. The components on the board are then heated by conduction. The circuit board, because it has a large surface area, absorbs the thermal energy more efficiently, then distributes this energy to the components. Because of this effect, the main body of a component may be up to 30 degrees cooler than the adjacent solder joints.

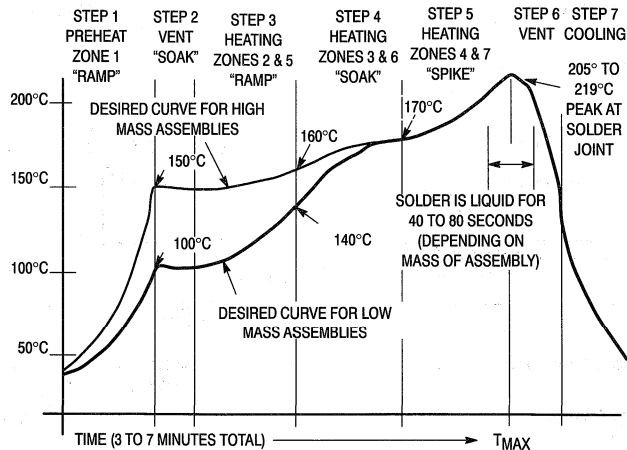
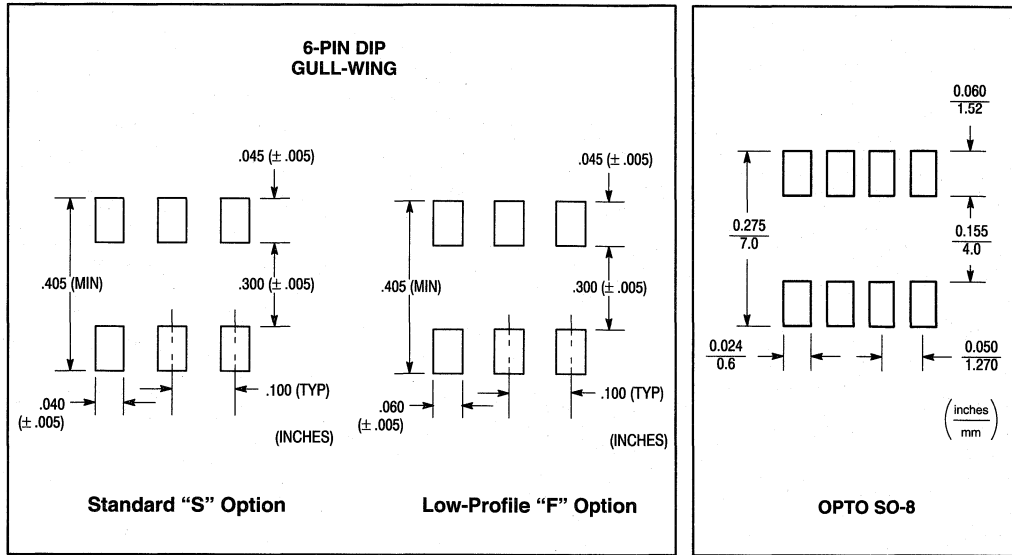

Figure 1. Typical Solder Heating Profile

Footprints for Soldering



1. The first part of the document discusses the importance of maintaining accurate records of all transactions and activities. It emphasizes that this is crucial for ensuring transparency and accountability in the organization's operations.

2. The second part outlines the various methods and tools used to collect and analyze data. This includes both traditional manual methods and modern digital technologies, highlighting the benefits of each approach.

3. The third part focuses on the challenges and risks associated with data management, such as data loss, security breaches, and compliance issues. It provides strategies to mitigate these risks and ensure the integrity of the data.

4. The fourth part discusses the role of data in decision-making and strategic planning. It explains how data-driven insights can help organizations identify trends, opportunities, and areas for improvement.

5. The fifth part covers the legal and ethical considerations surrounding data collection and use. It stresses the importance of obtaining proper consent and adhering to relevant regulations to protect individual privacy.

6. The sixth part addresses the future of data management, including emerging trends like artificial intelligence, big data, and cloud computing. It offers perspectives on how these technologies will shape the way organizations handle their data.

7. The seventh part provides a summary of the key points discussed throughout the document and offers final thoughts on the importance of a robust data management strategy.

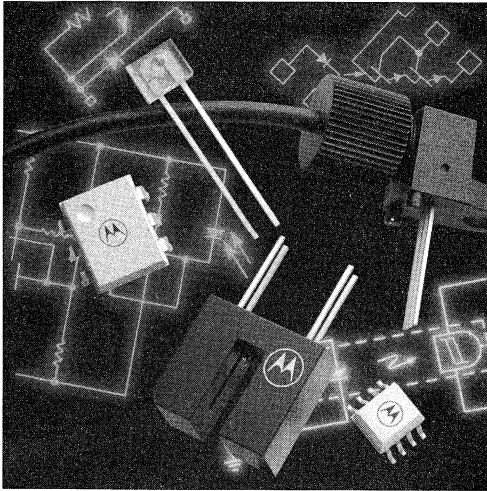

Section Thirteen

Package Outline Dimensions

Package Outline Dimensions

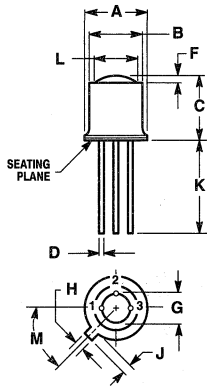

STYLE 1:
PIN 1: EMITTER
2. BASE
3. COLLECTOR

STYLE 4:
PIN 1: OUTPUT
2. V_{CC}
3. GROUND

NOTES:

- LEADS WITHIN 0.13 mm (0.005) RADIUS OF TRUE POSITION AT SEATING PLANE, AT MAXIMUM MATERIAL CONDITION.
- PIN 3 INTERNALLY CONNECTED TO CASE.

DIM	MILLIMETERS		INCHES	
	MIN	MAX	MIN	MAX
A	5.31	5.84	0.209	0.230
B	4.52	4.95	0.178	0.195
C	4.57	6.48	0.180	0.255
D	0.41	0.48	0.016	0.019
F	—	1.14	—	0.045
G	2.54 BSC		0.100 BSC	
H	0.99	1.17	0.039	0.046
J	0.84	1.22	0.033	0.048
K	12.70	—	0.500	—
L	3.35	4.01	0.132	0.159
M	45° BSC		45° BSC	

CASE 82-05

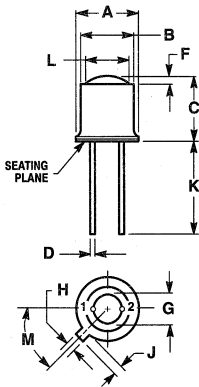

STYLE 1:
PIN 1: ANODE
2. CATHODE

NOTES:

- PIN 2 INTERNALLY CONNECTED TO CASE.
- LEADS WITHIN 0.13 mm (0.005) RADIUS OF TRUE POSITION AT SEATING PLANE AT MAXIMUM MATERIAL CONDITION.

DIM	MILLIMETERS		INCHES	
	MIN	MAX	MIN	MAX
A	5.31	5.84	0.209	0.230
B	4.52	4.95	0.178	0.195
C	5.08	6.35	0.200	0.250
D	0.41	0.48	0.016	0.019
F	0.51	1.02	0.020	0.040
G	2.54 BSC		0.100 BSC	
H	0.99	1.17	0.039	0.046
J	0.84	1.22	0.033	0.048
K	12.70	—	0.500	—
L	3.35	4.01	0.132	0.159
M	45° BSC		45° BSC	

CASE 209-01

PACKAGE OUTLINE DIMENSIONS (continued)

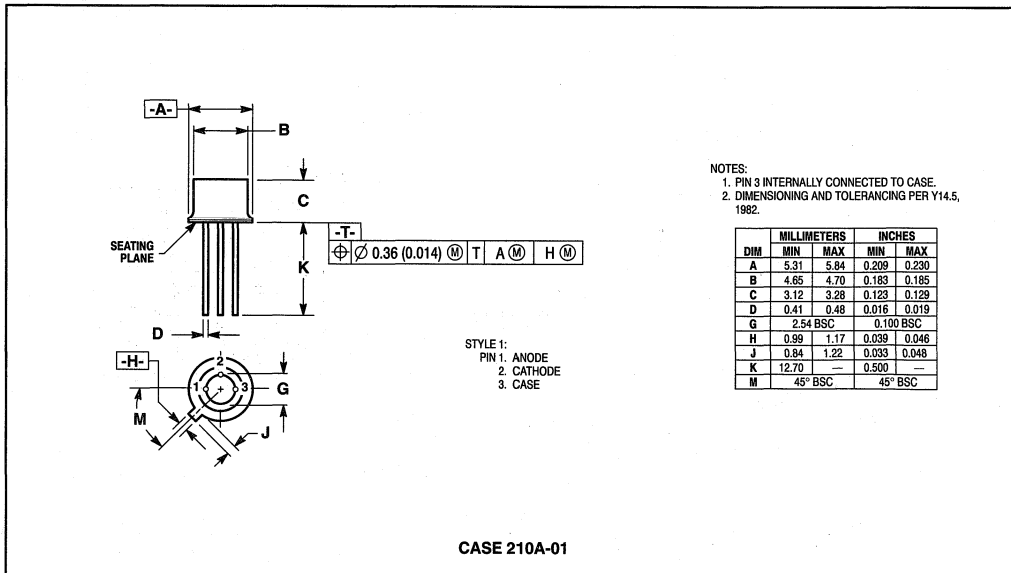
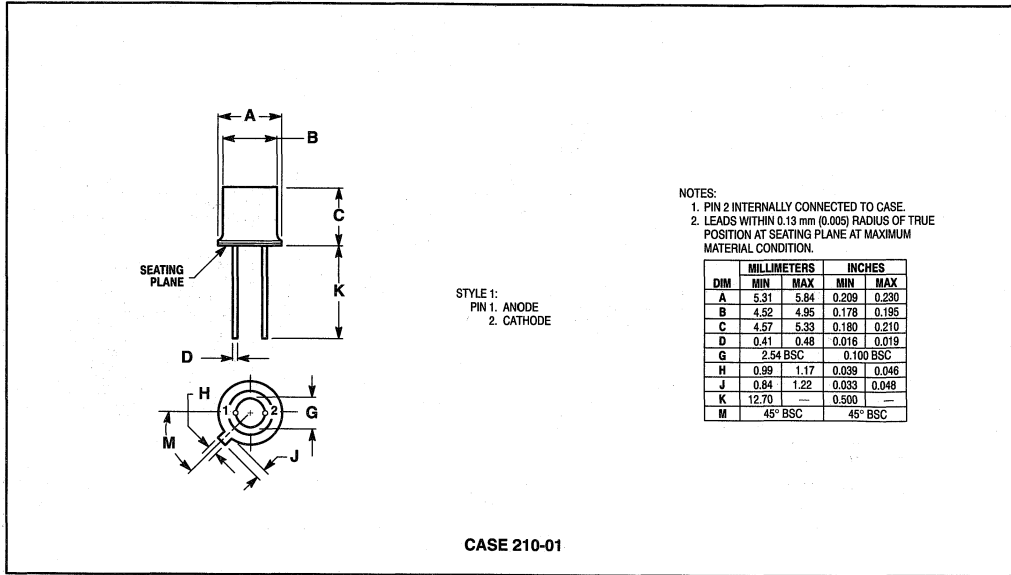

PACKAGE OUTLINE DIMENSIONS (continued)

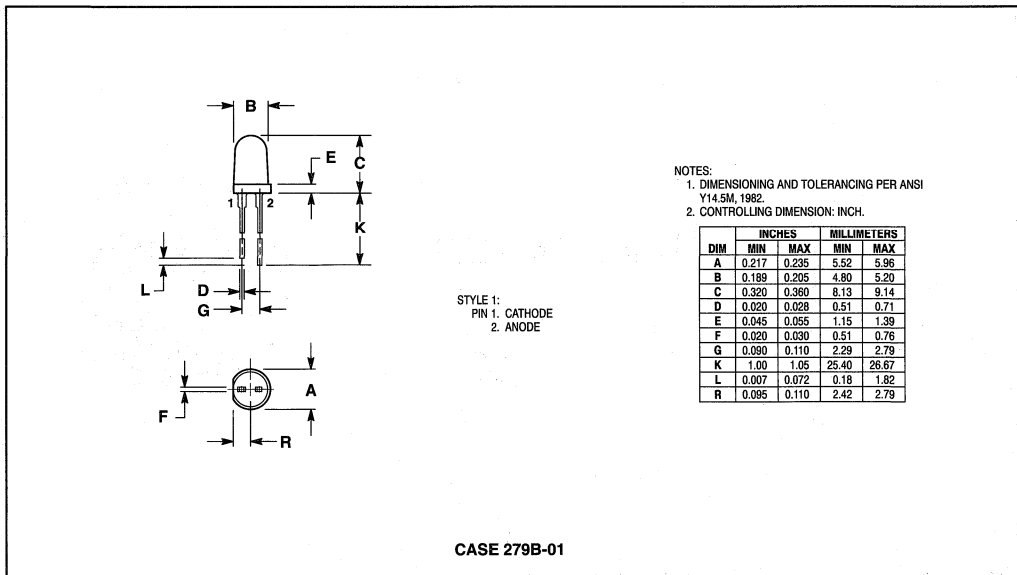
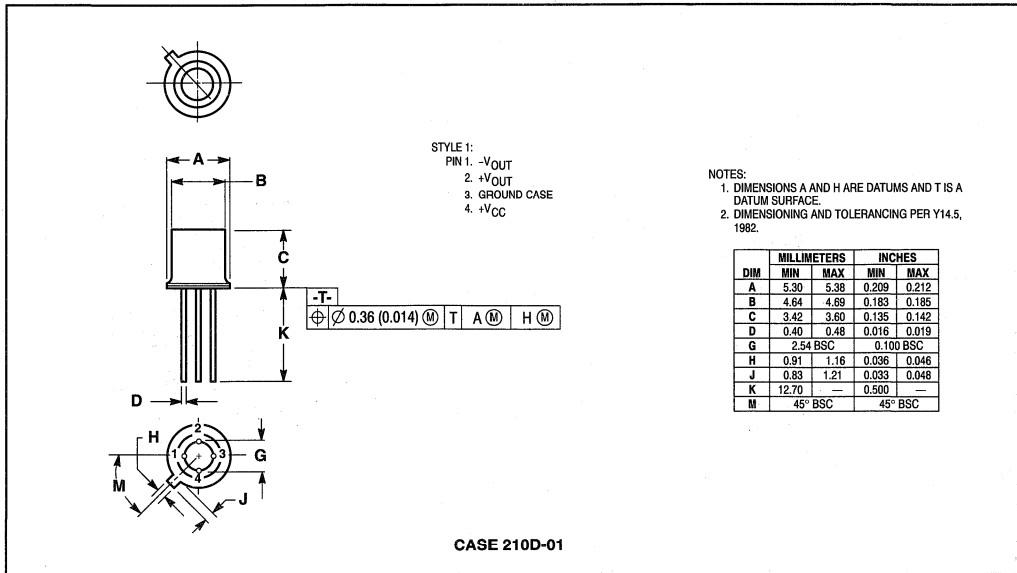

PACKAGE OUTLINE DIMENSIONS (continued)

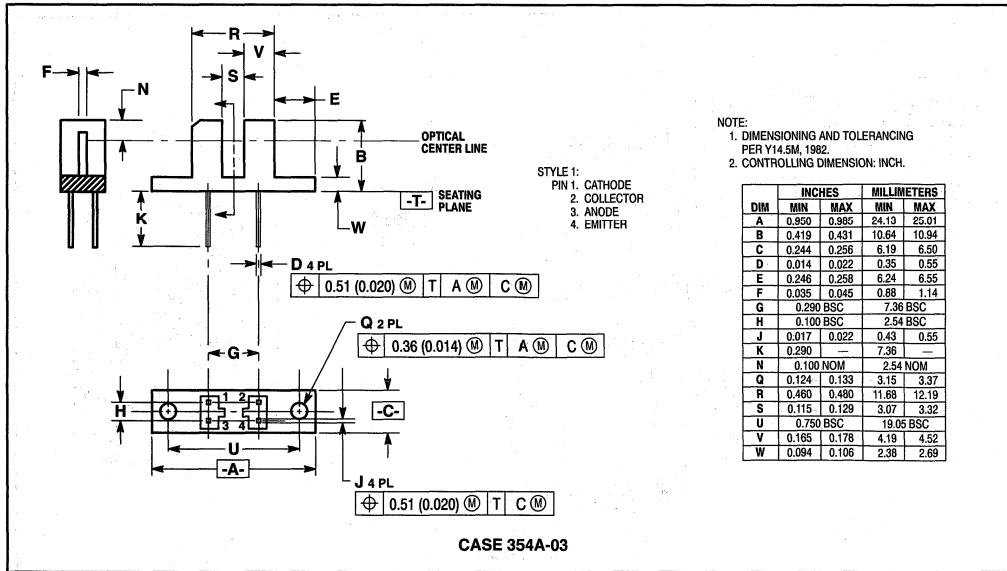
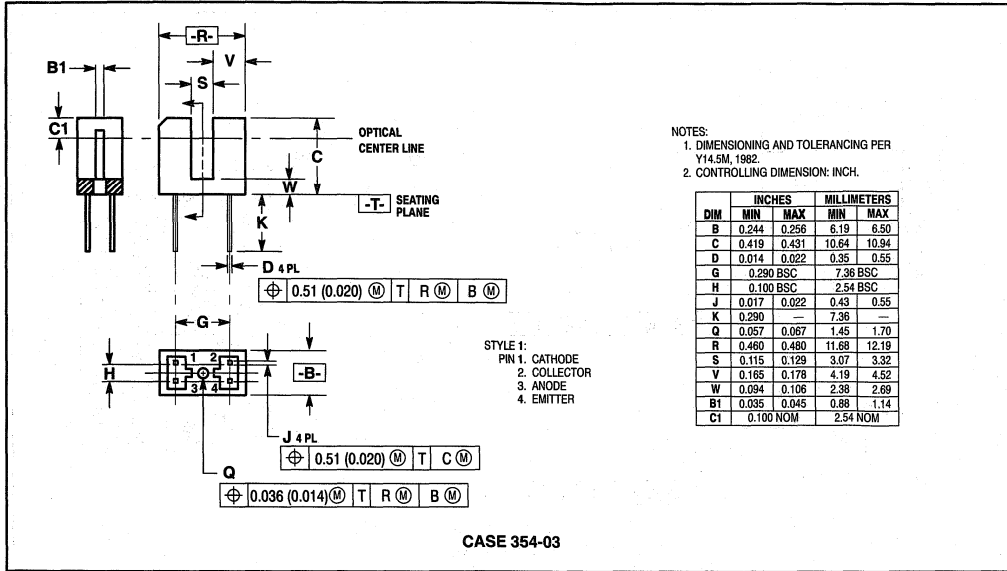

PACKAGE OUTLINE DIMENSIONS (continued)

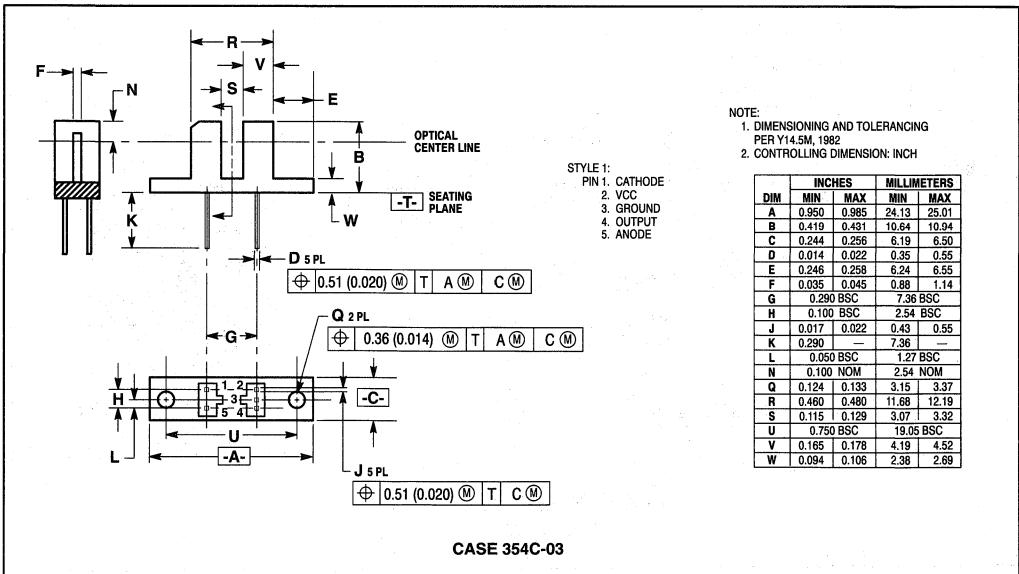
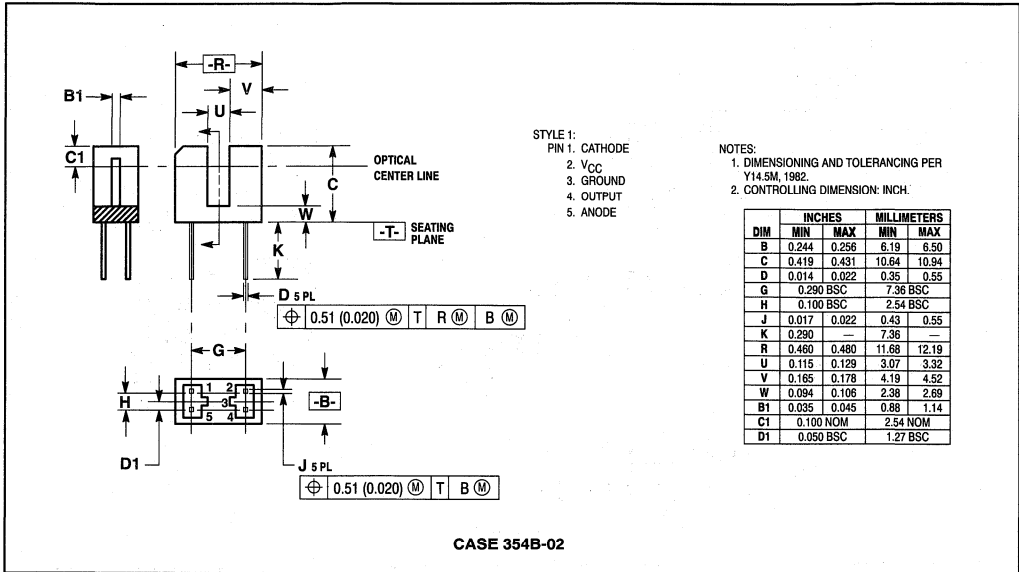

PACKAGE OUTLINE DIMENSIONS (continued)

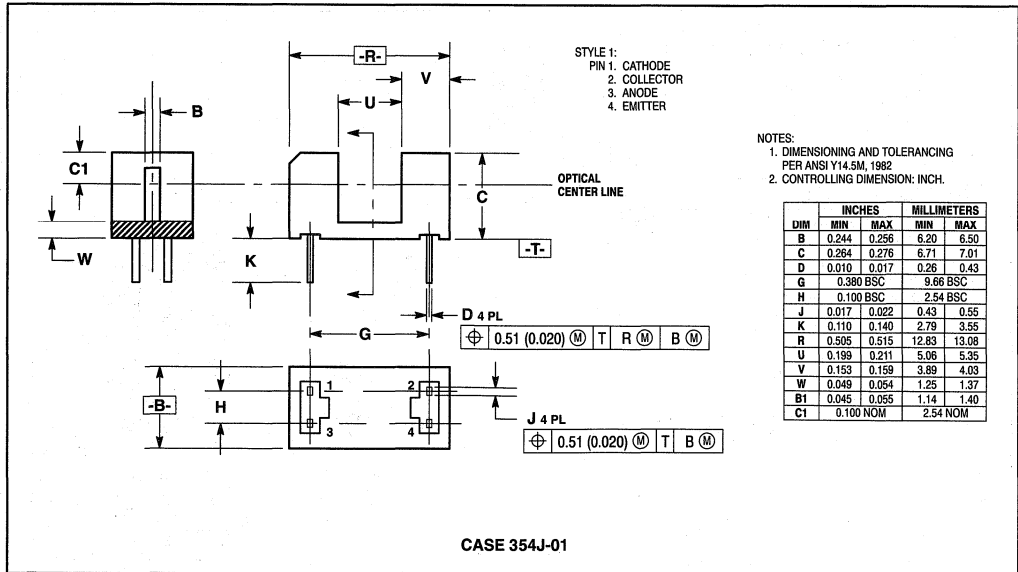
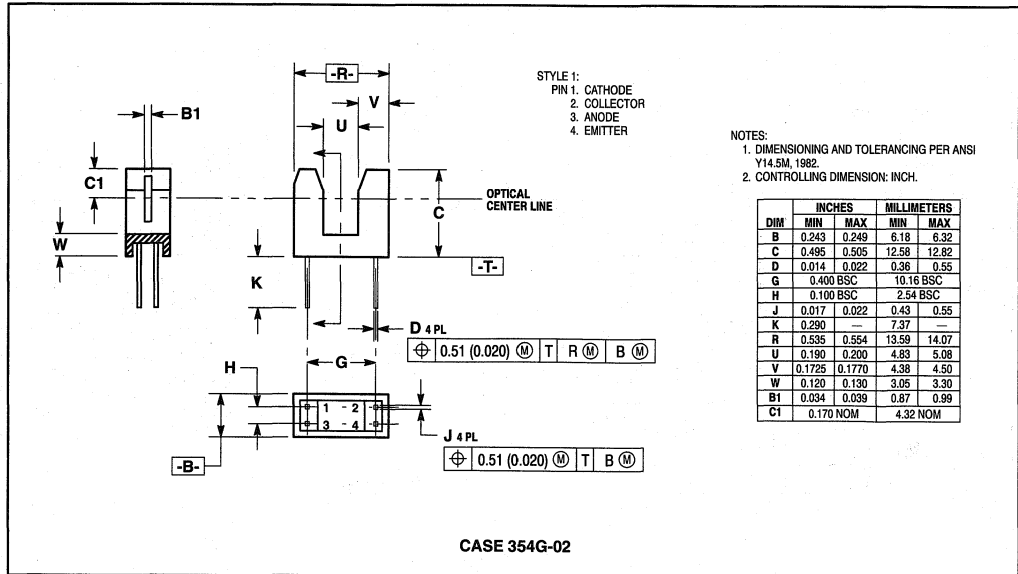

PACKAGE OUTLINE DIMENSIONS (continued)

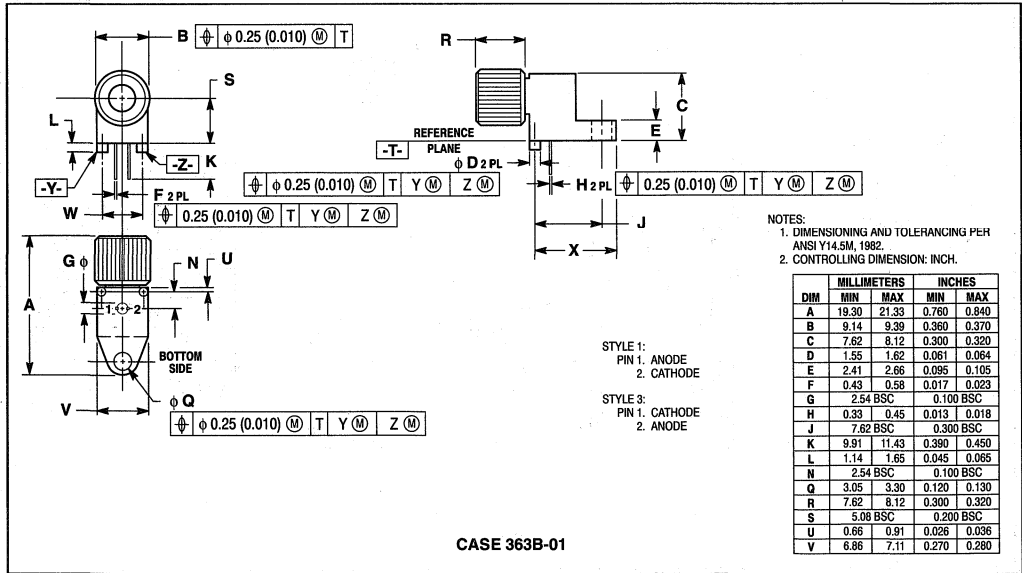
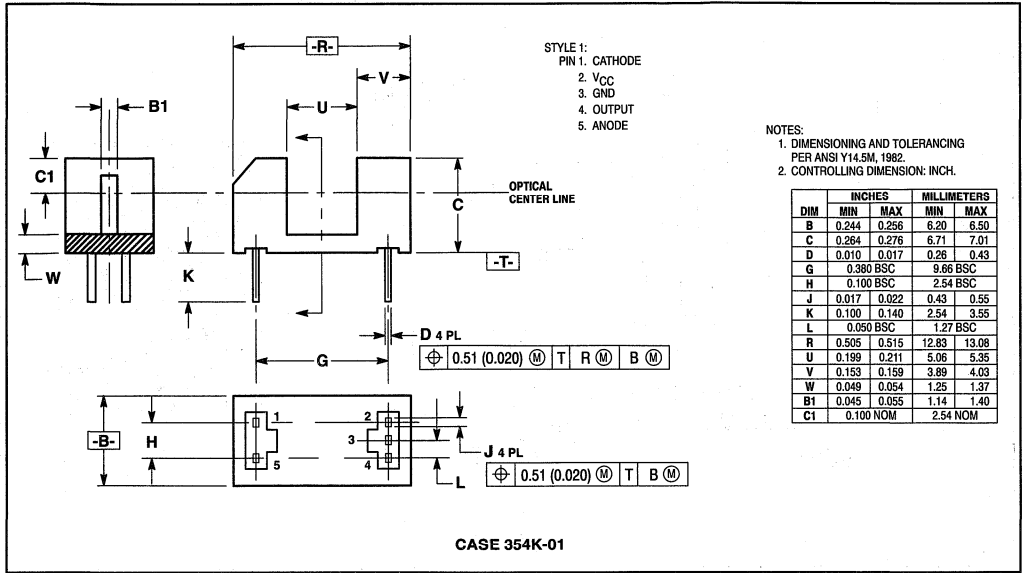

PACKAGE OUTLINE DIMENSIONS (continued)

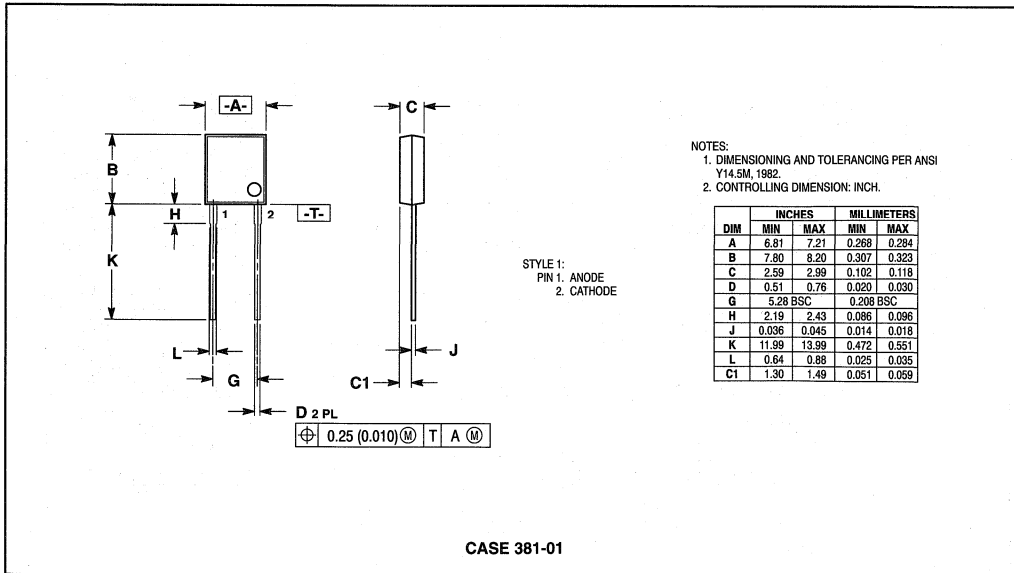
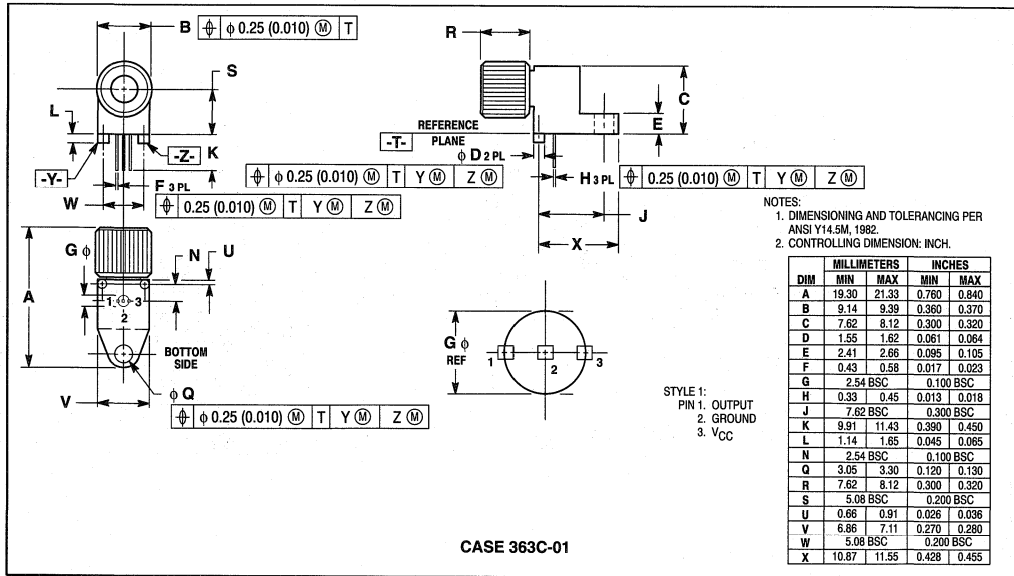

PACKAGE OUTLINE DIMENSIONS (continued)

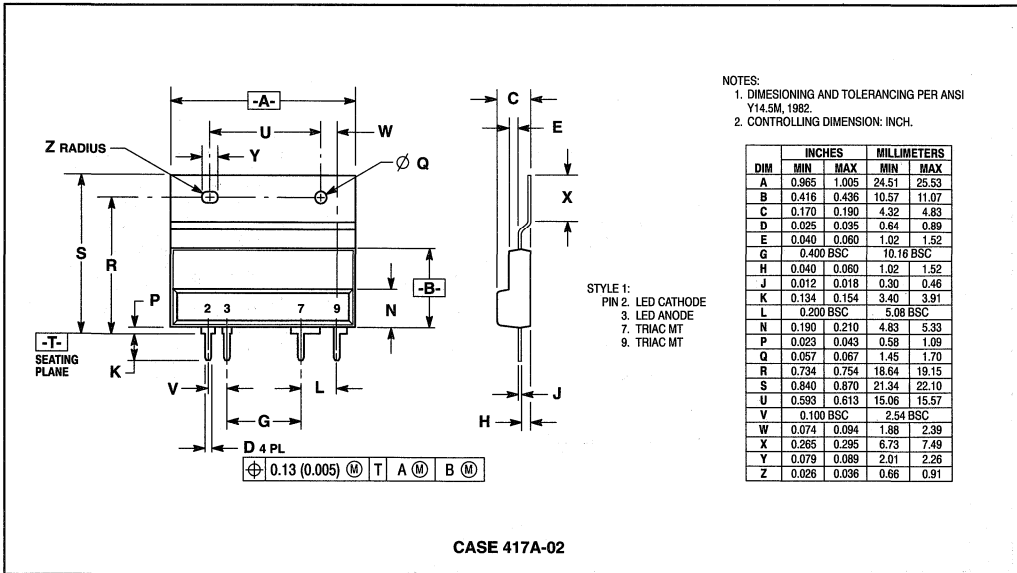
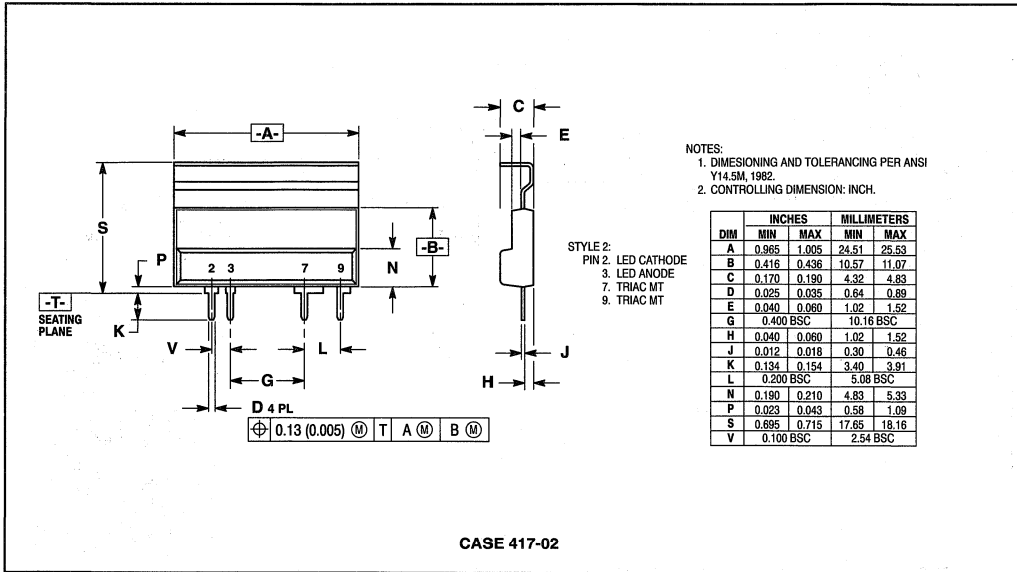

PACKAGE OUTLINE DIMENSIONS (continued)

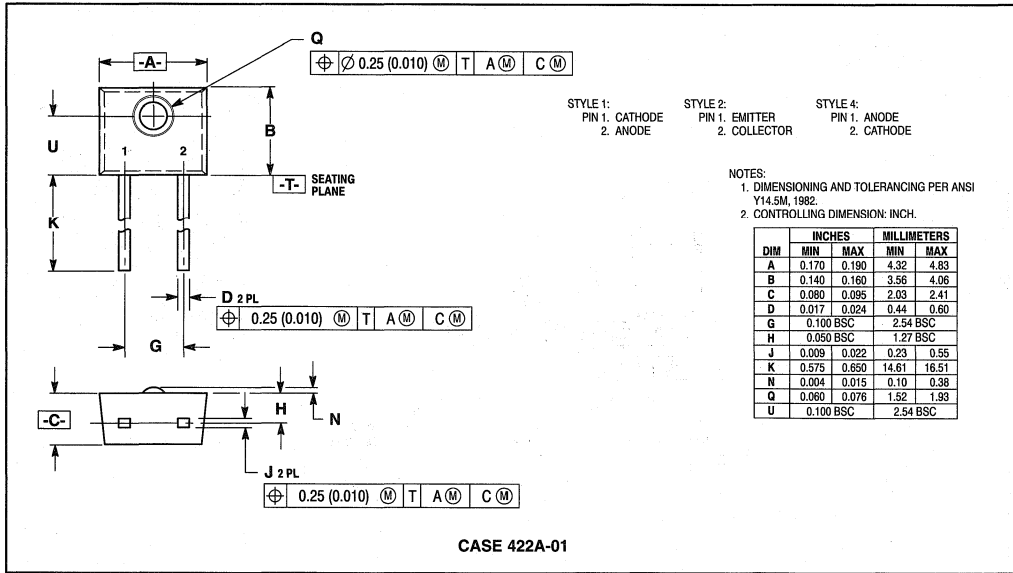
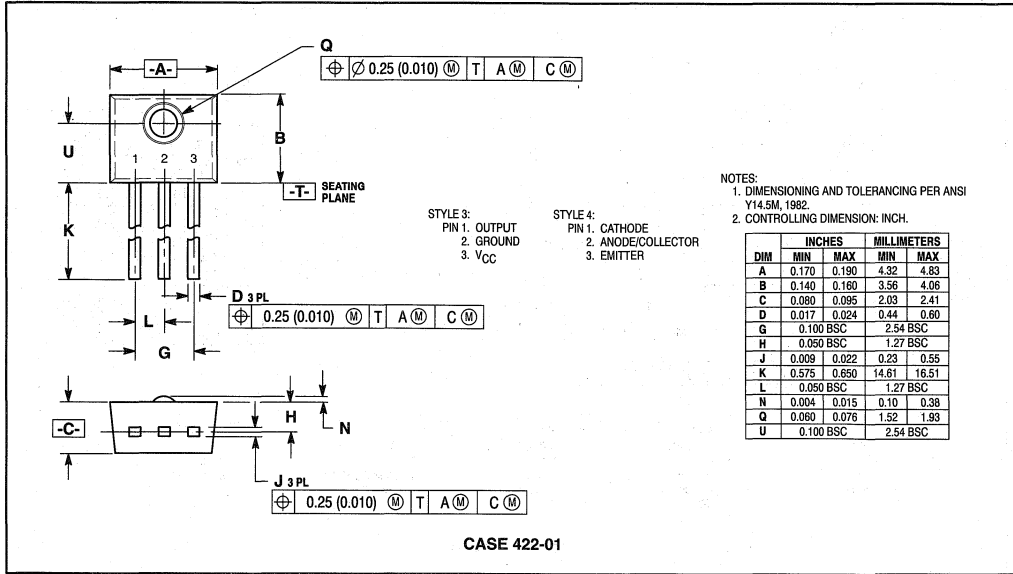

PACKAGE OUTLINE DIMENSIONS (continued)

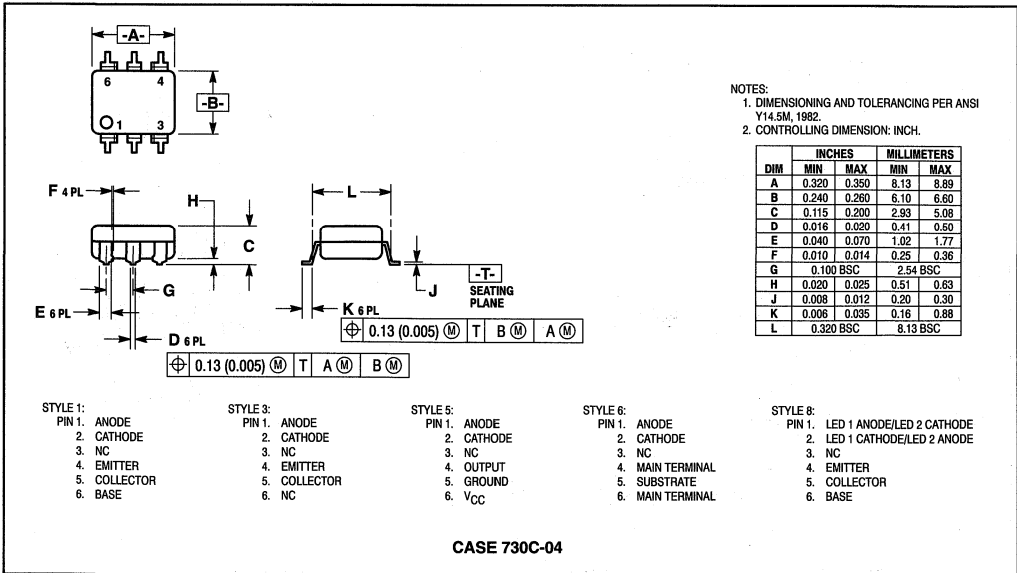
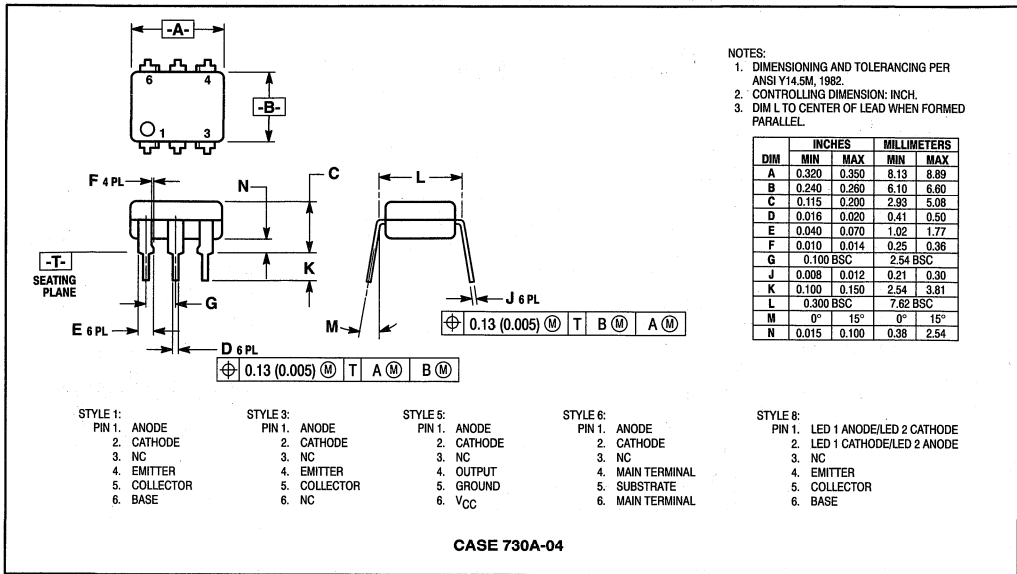

PACKAGE OUTLINE DIMENSIONS (continued)

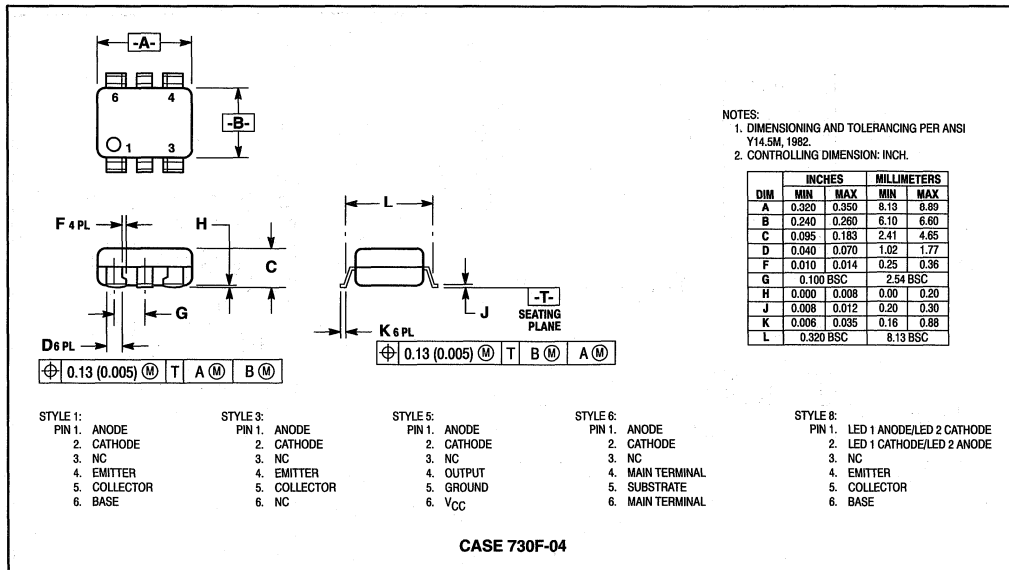
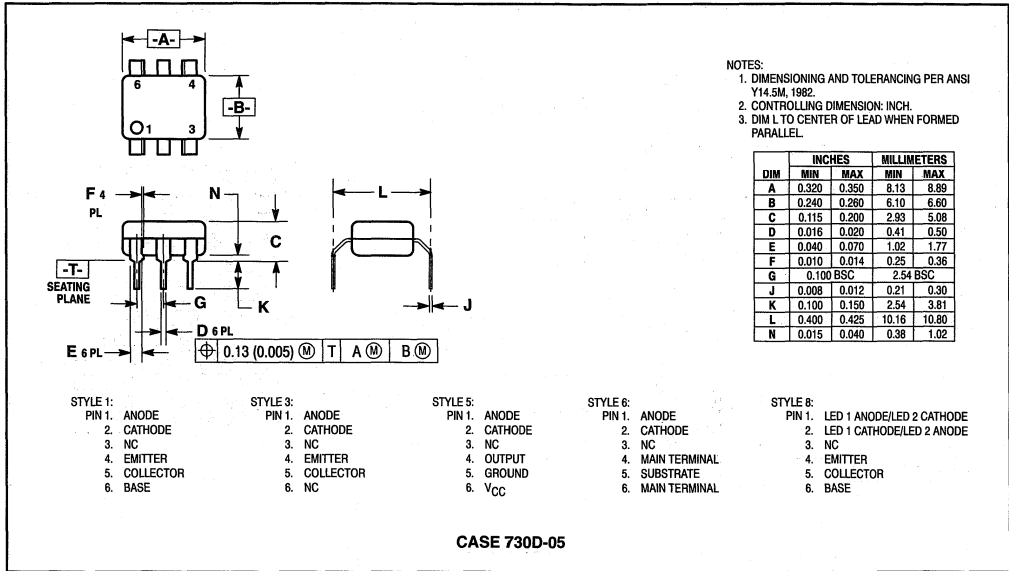

PACKAGE OUTLINE DIMENSIONS (continued)

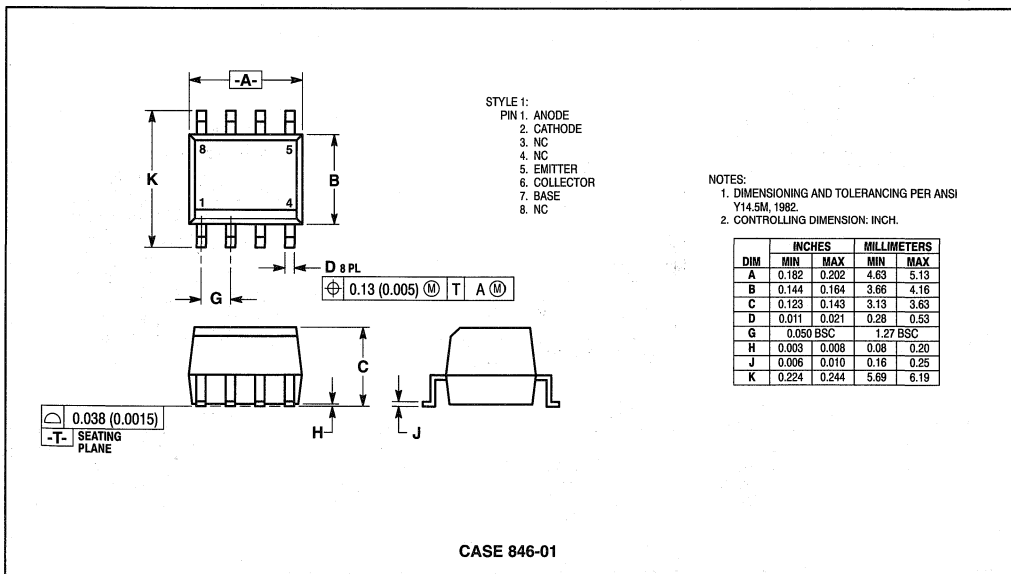
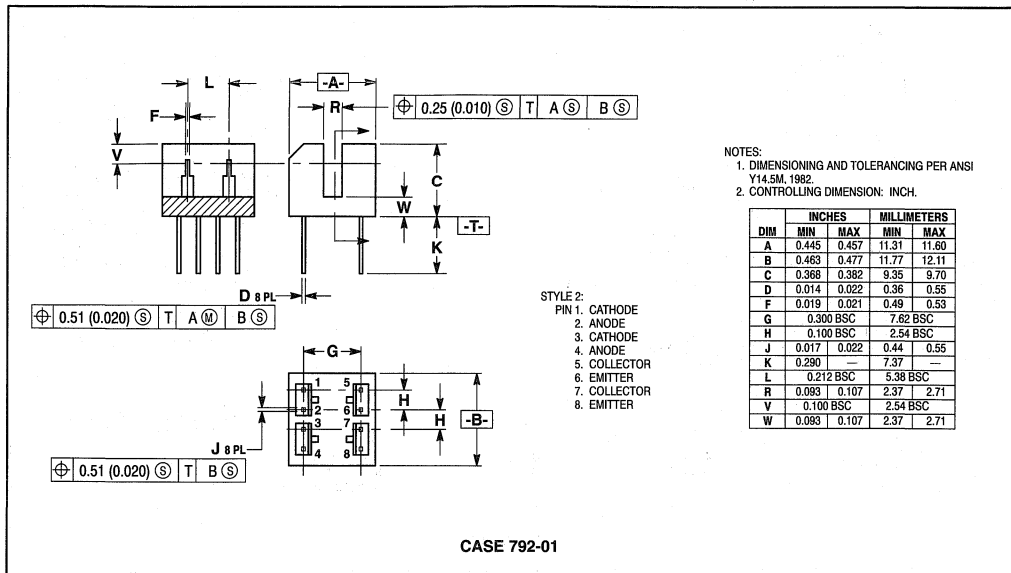

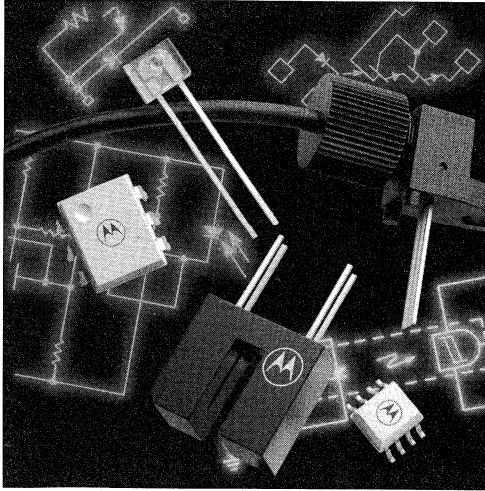

Section Fourteen

Appendices







Appendix 1	14-2
Safety Standards Information	14-2
VDE 0884 Approved Optocouplers	14-5
Appendix 2	14-12
Marking Information for Optoelectronic Products	14-12
Appendix 3	14-14
Reference Table for Optoelectronic Devices without Individual Data Sheets	14-14
Appendix 4	14-15
Definitions, Characteristics, and Ratings	14-15
Appendix 5	14-17
Standard Warranty Clause	14-17

APPENDIX 1

Safety Regulatory Approvals for Motorola's "Global" Optoisolators

Motorola's entire line of 6-PIN optoisolators are approved by all major safety regulatory agencies.

Safety Standard Approvals for 6-pin Optoisolators

	 VDE	 UL	 CSA	 SETI	 SEMKO	 DEMKO	 NEMKO	BS
MOCXXXX	* ⁽¹⁾	*	*	*	*	*	*	*
SOCXXXX	* ⁽¹⁾	*	*	*	*	*	*	*
4NXXXXXX	* ⁽¹⁾	*	*	*	*	*	*	*
H1XXXXXX	* ⁽¹⁾	*	*	*	*	*	*	*
MCXXXXXX	* ⁽¹⁾	*	*	*	*	*	*	*
TIXXXXXX	* ⁽¹⁾	*	*	*	*	*	*	*
CNXXXXXX	* ⁽¹⁾	*	*	*	*	*	*	*

* = Approved

Regulatory Approval Certification Index

Regulatory Agency	Certificate File Number
VDE0883	41853 (expired 12/31/91)
VDE0884 ⁽¹⁾	62054 (replaces VDE0883)
UL (isolation)	E54915
UL (flammability)	E-8436
CSA	LR93592
SETI	41990
SEMKO	9313138
DEMKO	Approved per SEMKO
NEMKO	A99177
BABT	CR/0117

Note: Motorola's 8-Pin surface mount optocouplers are approved by UL only and have a guaranteed Isolation Voltage of 2500 Vac(rms).

All Motorola 6-Pin optocouplers are 100% tested for Isolation Voltage and are guaranteed to 7500 Vac(peak).

UL Flammability Rating = 94VO (File number E-8436) for all optocouplers.

(1) VDE 0884 testing is an option; the suffix letter "V" must be added to the standard part number.

VDE Approved Optoisolators

VDE has approved Motorola's entire portfolio of 6-pin DIP optoisolators against their new components standard VDE 0884 which replaces VDE 0883. The VDE 0884 components standard requires additional electrical testing to a stringent isolation partial discharge test.

The VDE 0883 specification expired 12/31/91. Motorola optoisolators can now be ordered to comply with the VDE 0884 specification.

VDE approval is based on mechanical and electrical performance of the Motorola package, shown in Figure 3. This 6-Pin DIP package incorporates specially developed materials and assembly processes optimizing thermal and moisture stability while maintaining the high level of LED life and isolation voltage. All Motorola 6-pin DIP optoisolators are made in this package, and have these approvals.

VDE 0884 Component Standard (replaces VDE 0883)

Electrical ratings in this standard are:

Input-to-Output Voltage, 1 second

$V_{PR1} = 1.6 V_{IDRM}$, Partial Discharge < 5 picocoulombs,
 $V_{PR1} = 1280 V(pk)$

Maximum operating peak voltage, $V_{IDRM} = 800 V(pk)$

Isolation resistance: $V_{I-O} = 500 Vdc$, $10^{11} \Omega$, $T_A = 100^\circ C$.

Note: The isolation partial discharge test V_{PR1} , is performed after the completion of the high voltage withstand (hipot) tests.

VDE 0883 Component Standard (expired 12/31/91)

Electrical ratings in this standard were:

Isolation withstand voltages:

3750 V_{RMS} , 1 min, $T_A = 100^\circ C$

5300 Vdc, 1 min, $T_A = 100^\circ C$

Isolation surge withstand voltage:

10 kV per IEC 65, 50 discharges

Isolation resistance:

$10^{11} \Omega$, 500 Vdc, $T_A = 100^\circ C$

NOTE: **VDE 0884/8.87 testing is an option**; the suffix letter "V" must be added to the standard part number. (See below.)

Standard thru hole — MOC3063V

.4" wide spaced leadform — MOC3063TV (to satisfy 8 mm spacing requirement)

Standard-profile surface mount — MOC3063SV

Low-profile surface mount — MOC3063FV

Tape and Reel for surface mount — MOC3063S/FR2V

Optoisolators, a block diagram of which is shown in Figure 1, are devices which contain at least one emitter, which is optically coupled to a photo-detector through some sort of an insulating medium. This arrangement permits the passage of information from one circuit, which contains the emitter, to the other circuit containing the detector.

Because this information is passed optically across an insulating gap, the transfer is one-way; that is, the detector cannot affect the input circuit. This is important because the emitter may be driven by a low voltage circuit utilizing an MPU or logic gates, while the output photo-detector may be part of a high voltage DC or even an ac load circuit. The optical isolation prevents interaction or even damage to the input circuit to be caused by the relatively hostile output circuit.

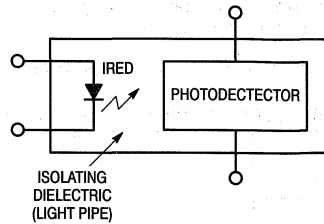

Figure 1. Block Diagram of Optoisolator

Various geometric designs have been used over the years for the internal light cavity between the emitter and detector. Motorola is the industry leader in isolation technology. All 6-pin optoisolators are guaranteed to meet or exceed 7500 Vac (pk) input-to-output isolation. See Figure 2.

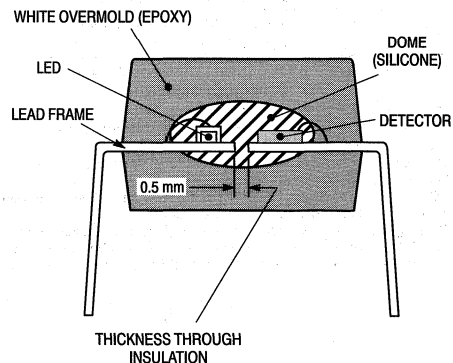

Figure 2. Geometric Design for Optoisolators

VDE Approved Optoisolators (continued)

Equipment Standards Compliance

With the approval of the Motorola package to these component standards, combined with its VDE approval ratings, a wide range of Equipment Standards are covered. The table below summarizes these Equipment Standard coverages.

Two levels of electrical interface, or insulation, are used: 1. Reinforced, or safe, insulation; 2. Basic insulation.

Reinforced Insulation (sometimes referred to as "safe electrical isolation") is required in an optoisolator interfacing between a hazardous voltage circuit, like an ac line, and a **touchable safe extra low voltage (SELV)** circuit.

Basic Insulation is required in an optoisolator which interfaces between a hazardous voltage circuit and a **non-touchable, extra low voltage (ELV)** circuit.

The 6-pin DIP optoisolators are suitable for both levels of electrical interface. The smaller SOIC-8 optoisolators comply with Basic Insulation standards only.

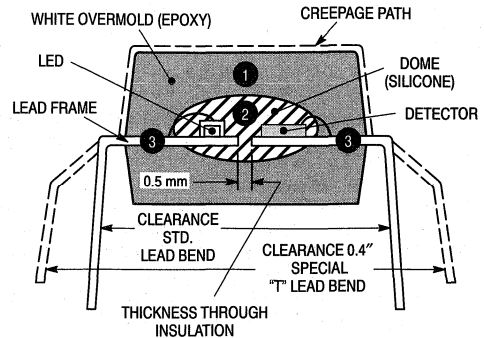

Figure 3. "DOME" Package

Mechanical ratings are shown in the table below.

Examples for Safety Applications for Motorola VDE Approved Optoisolators

Standard (2)		Equipment	Requirements for reinforced (double) or safe insulation for equipment with an operating voltage up to 250 Vrms (line voltage to ELV or SELV interfaces)				
VDE (5)	DIN IEC		Creepage	Clearance (1)	Isolation Barrier	Dielectric Strength	Isolation Resistance
0806	950	Office Machines	[mm]	[mm]	[mm]	[kV RMS]	[Ω]
0805	950	Data Processing	8.0	8.0	0.5	3.75	7 x 10 ⁶
0804	—	Telecommunication	8.0	8.0	—	3.75	7 x 10 ⁶
0860	65	Electrical Household	8.0	8.0	—	2.5	2 x 10 ⁶
0113	204	Industrial Controls	6.0	6.0	0.4	3.0 (10)*	4 x 10 ⁶
0160	—	Power Installations with Electronic Equipment	8.0	8.0	—	2.5	1 x 10 ⁶
0832	—	Traffic Light Controls	8.0	8.0	—	2.7	1 x 10 ⁶
0883	—	Alarm Systems	8.0	8.0	—	2.5	4 x 10 ⁶
0831	—	Electrical Signal System for Railroads	8.0	8.0	—	2.5	2 x 10 ⁶
0110	—	General Std. for Electrical Equipment	8.0	8.0	—	2.0	2 x 10 ⁶
0883	—	Optoisolator Component Standard (obsolete 12/31/91)	8.5	8.3 (10) (1)	0.5	3.75 (10)*	10 x 10 ¹¹
0884(4)	—	Optoisolator Component Standard (replaces VDE0883)	>7.5	>7.5	0.5	—	10 x 10 ¹²
VDE Rating for Motorola 6-pin DIP Optoisolators							

All Motorola 6-pin DIP Optoisolators meet or exceed the requirements of above listed VDE and DIN IEC Standards.

* Impulse discharge withstand voltage.

(1) To satisfy 8.0 mm creepage path on a PC board Motorola offers a special lead bend of 0.4 inch on all 6-pin dual-in-line optoisolators. Order by attaching "T" to the end of the Motorola part number.

(2) VDE standards (translated into English language) and IEC standards can be ordered from the American National Standard Institute ANSI, 1430 Broadway, N.Y., N. Y. 10018, Sales Department, 212-642-4900.

(3) Creepage path distances are measured from lead to lead across the top, bottom and ends of the package body.

(4) VDE 0884 testing is an option; the suffix letter "V" must be added to the standard number.

(5) For more information regarding the use of VDE approved devices, refer to "VDE Circuit Board Layout Design Rules" in the Applications Information section.

VDE 0884 Approved Optocouplers

Prepared by: Horst Gempe
Discrete Applications Engineering

INTRODUCTION

In mid 1990 Motorola received VDE 0884 approval for all optocouplers in a dome package. This opens an even wider range of safe isolation applications than with the former approval against VDE 0883. For example, optocouplers which have VDE 0884 approval are now accepted in appliances and it is expected that many other equipment standards will follow.

VDE 0884 is a new optocoupler standard for safe isolation. In many parts it has the same tests as the older VDE 0883 optocoupler standard, but there are two significant additions in safety philosophy which make this standard unique against all others. These additions are the introduction of the partial discharge test and the specification of the safety temperature, current and power dissipation ratings. Both contribute to an even safer isolation and avoid confusion of worst case conditions in order to still guarantee the safe isolation of optocouplers over the lifetime of the equipment.

Many parameters and classifications of this new optoisolator standard are harmonized with the newest basic safety standards such as isolation coordination standards VDE 0109, IEC664, and IEC664A, as well as equipment standards such as those for office machines and data processing equipment DIN/IEC950.

These new standards define and classify the environment to which the insulation system is exposed. The major new variables are the installation category and the pollution degree. Optocouplers are now rated to these new criteria. VDE plans to incorporate the partial discharge criterion into the basic standards, as well as into the individual equipment standards in the near future.

While the new standards are much better defined than the older ones, they demand intimate knowledge from the equipment designer about all conditions to which the equipment is exposed and detailed information about the safety parameters and ratings of the optoisolator.

This application note informs the user of Motorola optoisolators about the VDE safety ratings, classification and performance, and gives guidance in applying these ratings to the requirements of the individual equipment standards.

VDE Data Sheet

Table 1 shows the Motorola Dome Optocouplers for safe electrical isolation in accordance with VDE 0884.

Table 1. VDE 0884 Ratings for Motorola Dome Optocouplers – VDE Approval Document No. 62054

Description	Symbol	Rating	Unit
Installation category (DIN VDE 0109, 12/83, Table 1)			
Rated line voltage < 600 V _{rms}	—	I to III	—
Rated line voltage < 300 V _{rms}	—	I to IV	—
Climatic category (DIN IEC 68 part 1/09.80)	—	55/100/21	—
Pollution degree (DIN VDE 0109, 12 /83)	—	2	—
Creepage path between input and output	—	> 7.5	mm
Clearance between input and output	—		
Standard leadform 0.3"	—	> 7.5	mm
Special leadform 0.4"	—	> 10	mm
Thickness through insulation (insulation barrier)	—	0.5	mm
Comparative tracking index (DIN IEC 112/VDE 303 part 1/ 06.84)	CTI	175	—
Isolation group per VDE 0109	—	IIIa	—

Table 1. VDE 0884 Ratings for Motorola Dome Optocouplers – VDE Approval Document No. 62054 (cont)

Description	Symbol	Rating	Unit
Isolation resistance at VI/O = 500 Vdc			
$T_A = 25^\circ\text{C}$	R_{ISO}	10^{12}	Ω
$T_A = 100^\circ\text{C}$	R_{ISO}	10^{11}	Ω
$T_A = 175^\circ\text{C}$	R_{ISO}	10^9	Ω
Maximum operating peak voltage	V_{IORM}	800	Vpk
Production input to output test voltage, 1 second $V_{pr1} = 1.6 \times V_{IORM}$, Partial discharge < 5 pC	$V_{pr1}^{(1)}$	1280	Vpk
Qualification input to output test voltage, 1 minute $V_{pr2} = 1.2 V_{IORM}$, Partial discharge < 5 pC	$V_{pr2}^{(1)}$	960	Vpk
Maximum transient overvoltage $V_{tr} = 10$ seconds Qualification Test	V_{tr}	6000	Vpk
Operating Temperature	T_A	-55 to +100	$^\circ\text{C}$
Storage Temperature	T_{stg}	-55 to +150	$^\circ\text{C}$

Maximum Safety Temperature, Power and Current Ratings in Case of a Single Fault Condition

Description	Symbol	Rating	Unit
Maximum package safety temperature	T_{si}	175	$^\circ\text{C}$
Maximum LED safety input current, $P_{si} = 0$, $T_A = 25^\circ\text{C}$ (Linear derate from 25°C to zero at $T_A = T_{si} = 175^\circ\text{C}$)	I_{si}	400	mA
Maximum detector safety power dissipation, $T_A = 25^\circ\text{C}$ (Linear derate from 25°C to zero at $T_A = T_{si} = 175^\circ\text{C}$)	P_{si}	800	mW

(1) The isolation partial discharge tests V_{pr1} , V_{pr2} in accordance with VDE 0884 are performed after high voltage withstand (hipot) tests.

Explanation of VDE 0884 ratings

Installation Category

The four installation categories are based on the principles of insulation coordination as found in VDE 0109 and IEC 664. These standards categorize and specify the expected line transients to earth ground within an ac line installation and distribution system.

The highest transients are expected at installation category four, which is the primary supply level from overhead lines or underground cable systems and its associated spark gap and over-current protection equipment. The locations are the main fuse and the service entrance. For a 380 V ac rms system, the peak transient voltage may be up to 6000 Vpk.

Installation category three follows installation category four and is the fixed electrical installation with its individual circuit breakers for each branch within a building. For a 380/220 Vrms installation peak, transients of 4000 V are expected.

Installation category two is portable equipment such as appliances which use the outlets of the fixed electrical installation. Transients of up to 2500 Vpk are expected.

Installation category one is special equipment or individual circuits within portable equipment which operate on the secondary voltage of a power supply or transformer with max 60 V ac or dc peak. Examples are telecommunication, data processing and other electronic equipment. Even in these cases, transients of up to 500 Vpk in respect to earth ground are possible, unless transient suppression is provided.

Climatic Category 55/100/21

These numbers specify the environmental condition for the approval test. The temperature range is -55 to +100 $^\circ\text{C}$ with a 21 day humidity soak.

Pollution Degree

There are four pollution degrees. Pollution degree one specifies non-conductive or only dry non-conductive pollution which is found inside most electronic equipment in a controlled environment such as an office.

Pollution degree 2 assumes normally dry, non-conductive pollution with occasional temporary conductivity caused by condensation. Examples are appliances like washers, dishwashers and equipment in non-temperature controlled environments.

Pollution degree three has expected conductive pollution, and pollution degree four assumes persistent conductive pollution as found in an outside environment such as rain or snow.

Creepage and Clearance

The creepage path is the shortest distance on the surface of the optocoupler package between input and output leads. The clearance is the shortest distance between input and output leads through air. A special lead bend is available which increases this distance and guarantees an adequate creepage part on the circuit board.

Comparative Tracking Index

This index indicates a insulator's withstand capability to surface deterioration caused by sparks or leakage currents over the creepage path. This may be the case when conductive pollution occurs. CTI is a relative number and is used to compare insulation materials. The higher the number, the better the resistance to deterioration. Glass and ceramics are very resistant and have a CTI of >600. Some circuit board materials are <100.

Isolation Group

The isolation group characterizes insulators to their resistance to tracking. Insulators which remain unaffected by the CTI test belong to isolation group I; insulators which erode or decompose with carbon residues are found in isolation group III.

- CTI –rating Isolation group
- ≥600 I
- 100–600 II
- 175–400 IIIa
- 100–175 IIIb

Isolation Resistance

In the qualification test this parameter is measured after the environment's 21-day humidity soak and a short surface dry at ambient temperature at 500 Vdc, and at the maximum safety temperature $T_{SI} = 175^{\circ}\text{C}$. Motorola tests this parameter in production during the transient withstand test (hipot test).

Maximum Operating Peak Voltage V_{IORM}

This is the maximum repetitive peak voltage for safe isolation. In some equipment, it is not necessarily the peak line voltage. Switching power supplies, for example, may develop repetitive peak voltages between primary and secondary circuits exceeding the ac peak voltage by superimposing inductive voltage transients of the flyback transformer onto the line voltage.

Safe isolation of the insulation material is guaranteed when the optocoupler is operated within this rating, since partial discharge which might destroy the insulation barrier is guaranteed not to be present.

Partial Discharge Test Voltage V_{pr1} and V_{pr2}

Partial discharge is a corona discharge in a part of the insulation barrier caused by voids or locally high electrical field gradients. Partial discharge may decompose or erode the insulation material over time and lead to a permanent insulation failure. The VDE 0884 safety philosophy demands that the peak repetitive operating voltage is lower than the partial discharge initiation and extinction voltage of the optocoupler, thus avoiding the cause of an isolation degradation or breakdown over time. All optocouplers have to pass a partial discharge test at 1280 V ac peak for one second. During this time the device is monitored for partial discharge by a highly sensitive narrow band RF circuit and the device is rejected when a partial discharge activity of 5 pico coulombs or larger is recorded.

Maximum Transient Overvoltage, V_{tr}

This is the classical hipot test which may lead to erosion, decomposition and consequent breakdown of the insulation barrier when the device is exposed over a long period of time. The qualification test is 10 seconds and must be considered to weaken the insulation barrier.

Many standards still demand the hipot test. To comply with these standards, Motorola tests 100 percent of all optocouplers for one second to a minimum of 6000 V ac peak (4200 V ac rms), while monitoring the leakage current. After this test, the devices have to pass the 1 second partial discharge test.

Maximum Safety Temperature, Power and Safety Ratings

The user of the optocoupler has to take care that the device is never operated above the specified maximum safety values. These ratings exceed the maximum ratings for proper electrical function of the part. The safety ratings only guarantee safe isolation under a single failure mode; they do not mean normal operating conditions.

Partial Discharge Theory and Test

The partial discharge only bridges a part of the insulation barrier between two conductors. These discharges may be adjacent to one of the conductors or within the insulation barrier. They may occur in cavities within the insulation or in layers with different dielectric properties. Sharp edges on conductors, cavities in solid insulation, or air gaps between a conductor and the insulation material, and layers with different dielectric materials do create highly localized electrical fields which lead to discharges. The energies of these discharges are very small, but over time they may lead to progressive deterioration of the dielectric properties of the insulation barrier until breakdown occurs. The length of time to destruction of the insulation barrier depends on the discharge energies involved and the insulation materials withstand capability to the discharges.

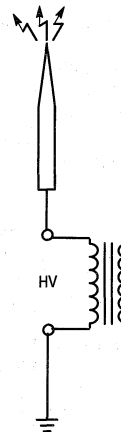

Figure 1a. Corona Discharge on a Needle Point

Figure 1a shows that corona discharge is induced into the air by a sharp needlepoint electrode which creates a high field gradient very close to the point. The voltage necessary to initiate corona discharge depends on the radius of the needle point, the polarity, the properties of the surrounding gas and its pressure. In this example, corona discharges start at 2700 V with positive charge and 2000 V with negative charge into the air at sea level atmospheric pressure and a needlepoint with a curvature radius of ~1 mil. Very sharp needlepoints show discharges already at ~500 V.

Figure 1b shows corona, or partial discharge between two glass plates. Since this discharge finds place only within a part of the insulation barrier, it is defined as partial discharge. The electrical field gradient in the air between the glass plates is much higher than within the glass plates because of the difference of the dielectric constant between glass and air. This arrangement is used to produce ozone, which demonstrates the resistance of glass to corona discharge.

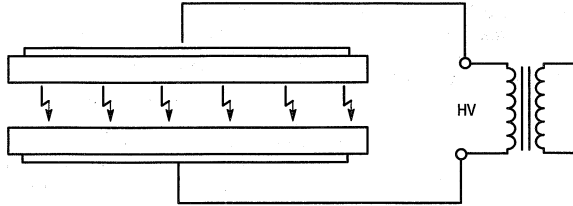

Figure 1b. Corona Discharge Between Two Glass Plates

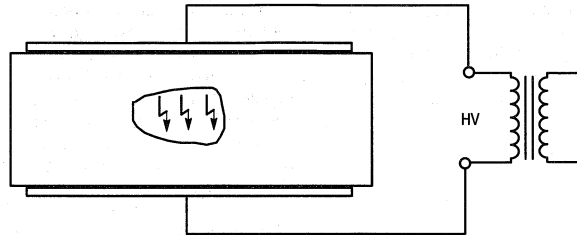

Figure 1c. Corona Discharge in the Void of an Insulator

Figure 1c shows a solid insulator with an enclosed void. Corona discharge is initiated in this void by the same mechanism as seen in Figure 1b.

Partial discharge in any test object has measurable quantities such as a charge (q) which is expressed in pico coulombs and a repetition rate (n.) per time unit which could be 1/2 cycle or one second.

Wideband Test Method

Figure 2 shows a simple detection method which consists of a variable partial discharge free high voltage transformer, a current limiting resistor, R1, a coupling capacitor, C1 and a load resistor R2. The partial discharge can be observed directly with an oscilloscope which should have a 100 MHz bandwidth and a sensitivity of 1 mv/div. Partial discharges generate short current pulses with a fast rise time in the ns region which generates a signal on the load resistor. Coupling capacitor C1 is so dimensioned that it appears as a very low impedance to the fast rising discharge pulses. For short discharge pulses the signal amplitude on the load resistor is proportional to the discharge energy within the device under test.

Narrowband Test Method

In Figure 3, R2 is replaced by an LC resonance tank circuit. The partial discharge pulses generate a dampened oscillatory waveform at the resonance frequency of the tank circuit. The capacitive leakage current of the device under test is now depressed due to the low impedance of the tank circuit at line frequency. Narrowband test methods are used because of their lower noise levels.

Calibration of the Detection Circuit

Discharges within the DUT cannot be directly measured, but they produce a signal on the terminal of the load resistor or LC tank circuit with an amplitude proportional to the discharge energy within the insulation. This energy or charge is defined as the apparent charge q. Apparent charge q can be simulated by charges instantaneously injected into the test circuit. It is now possible to correlate the response of the detection circuit to known charges and calibrate the output response signal amplitude to pico coulombs.

The energy q stored in a capacitor C at a voltage V is:
 $q = V \times C.$

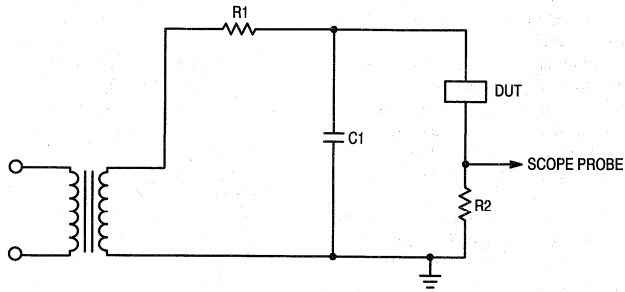

Figure 2. Wideband Partial Discharge Test Circuit

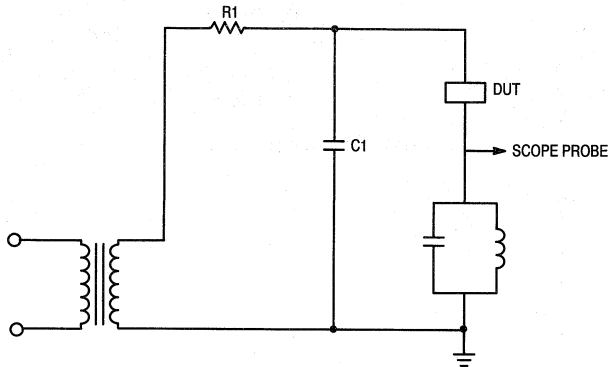

Figure 3. Narrowband Partial Discharge Test Circuit

Figure 4 shows a calibration generator consisting of a known capacitance C_c and a square wave generator with fast rise time (100 ns or less) and a known amplitude V_p and a repetition rate of 120 Hz. Calibration of the entire detection

circuit is performed with the high voltage switched off. By choosing $C_c = 10$ pF and a square generator with an adjustable peak voltage of .1 – 10 V, a partial discharge detection systems response can be calibrated from 1 pC to 100 pC.

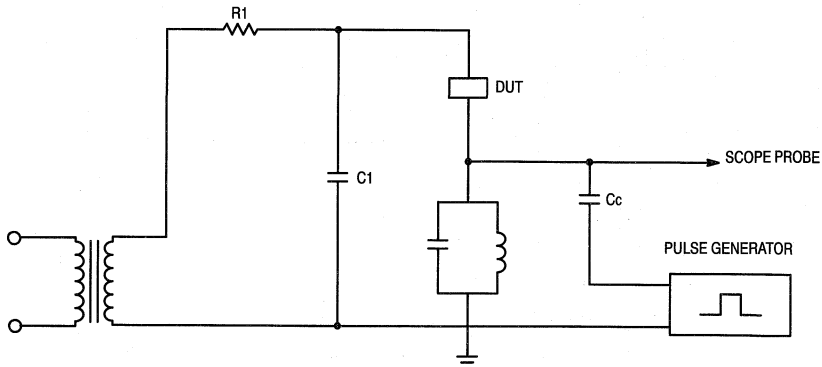

Figure 4. Narrowband Partial Discharge Test Circuit with Calibrator

Partial Discharge Measurement

A very important parameter of partial discharge besides its apparent charge q is the voltage at which it occurs, which is called initiation voltage, and the voltage at which it disappears, which is called extinction voltage. In most cases

the extinction voltage is found to be about 10–20% lower than the initiation voltage. For measurement of the initiation voltage, the ac voltage of the device under test is slowly raised until partial discharge is observed. When the voltage is raised further, more discharges per half cycle may be observed. Also

an increase of the energy of each individual discharge may be noted. By lowering the ac voltage the discharges will subside and the extinction voltage is found.

Great care must be taken that all high voltage conductors are smooth and without sharp edges. This avoids corona discharge into the surrounding air. Also incomplete galvanic contact to the device under test might lead to micro arcs which falsify the test results. The high voltage transformer must be absolutely free of partial discharge and protected from line transients and noise.

It is important to note that all partial discharge measurements for optocouplers are performed with an ac sinusoidal voltage of 50 or 60 Hz. Measurements of partial discharge with dc voltage show different results in initiation, extinction and repetition rates of the discharges.

VDE Standard Test Circuit

VDE uses the narrowband test method as shown in Figure 3 and a calibration circuit as shown in Figure 4. The

center frequency of the tank circuit may be any value from 150 kHz up to 5 MHz, but the 3 dB bandwidth must be 15 kHz. Tank circuits with the center frequency of the AM IF of 455 kHz are commonly used in combination with a parallel resistor to set the bandwidth. Calibrator rise time is 50 ns max and fall time between 100 – 1000 μ s. Coupling capacitor C must be 1 nF or greater. Partial discharge pulses of 1 pC must still be detectable.

VDE Partial Discharge Qualification Test

This test is performed after the environmental stress as described in Chapter 5 VDE qualification, test lot 1. The ac voltage is raised with 100 V/sec. to $V_{INITIAL}$, which is the maximum transient withstand voltage V_{Tr} specified by the manufacturer, and applied for 10 seconds. Partial discharge may occur under this condition. The voltage is then lowered to the manufacturer's specified voltage V_{pr2} , (which is 20% higher than the specified operating voltage) and maintained for 62 seconds. Partial discharge is monitored after a settling time of one second. No discharges above 5 pC may occur. See Figure 5.

Voltage curve in the partial discharge voltage measurement.

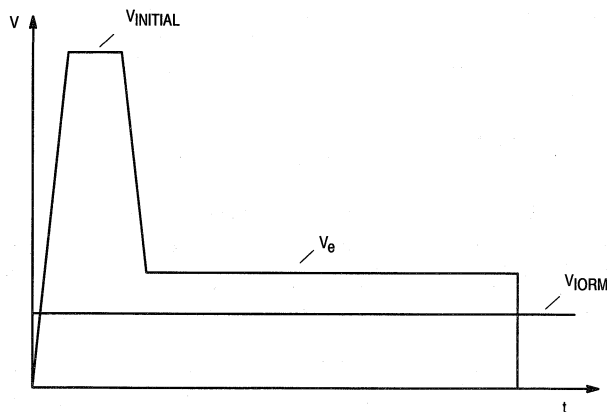

Voltage curve (ac) for type testing using environmental tests.

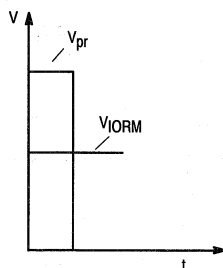

Test voltage curve (ac) for routine tests.

Figure 5. Voltage curve in the Partial Discharge Voltage Measurement

Manufacturer Production Test

The test voltage is suddenly raised to V_{pr1} which is 1.6 times the operating voltage V_{IORM} ; partial discharge is monitored for one second. Devices with a partial discharge above 5 pC are rejected.

Explanation of the Comparative Tracking Index (CTI) Test

This test classifies insulation materials to their resistance to deterioration caused by surface leakage currents in the presence of conductive pollutants.

Platinum electrodes are placed onto samples of the mold compound material used for the optocoupler's package. A conductive pollutant consisting of a solution of $NH_4 Cl$ and DI water is dropped between two platinum electrodes which are connected to an ac power source and a 0.5 A current circuit breaker. The number of drops which can be applied until the material under test decomposes and forms a conductive creepage path depends on the electrode voltage and the material itself. CTI is the voltage a test specimen can withstand without tracking, which means without tripping the circuit breaker when 50 drops are applied. CTI is found statistically by conducting many tests with different voltages where the amount of drops until the circuit breaker opens are recorded. Short tests for verification of a CTI rating keep the electrode voltage constant. Several samples have to pass 50 drops without signs of tracking.

VDE 0884 Qualification Test

Manufactures of optocouplers must supply samples to VDE and pass all tests as shown below.

Sample size 80 units

- Visual inspection
- Isolation voltage (@ $V_{pr1} = 1.6 V_{IORM}$)
- Functional test
- Creepage and clearance measurements
- Isolation resistance (@ 500 Vdc)
- Resistance to solder heat (260°C, 5 sec.)

Lot 1, 20 units

- 5 temperature cycles, dwell 3 hrs. at specified min., max. storage temperature.
- Vibration, 10 to 2000 Hz, 0.75 mm, 10 g.
- Shock, 100 g, 6 ms
- Dry heat, 16 Hr, $T_A = 100^\circ C$, $V_{iso} = V_{IORM}$ or min 700 Vpk
- 1 humid cycle @ $T_A = 55^\circ C$
- Cold storage, 2 Hr., @ min. storage temperature.
- Humid heat, 21 days, 40°C, RH 93%.
- End test after room temp. dry of 6 Hrs. for partial discharge @ $V_{IORM} \times 1.2$, 5 pC max., isolation resistance 1012 Ω @ 500 Vdc max 25°C.
- Isolation surge voltage 10 KV 50 discharges 1 nF,
- Isolation resistance min. 109 Ω .

Lot 2, 30 units

- Input overload safety test, $t = 72$ hrs., $T_A = T_{sj}$, $I = I_{sj}$
- End test for partial discharge @ V_{IORM} , 5 pC max.

Lot 3, 30 units

- Output overload safety test, $t = 72$ Hrs., $T_A = T_{sj}$, $P = P_{sj}$
- End test for partial discharge @ V_{IORM} , 5 pC max.

APPENDIX 2

Marking Information for Optoelectronic Products

Optoisolators/Optocouplers

Motorola 6-PIN DIP and SOIC-8 devices are **NOT** marked with the various option suffixes listed below:

Suffix	Description
"S"	Standard profile surface mount leadform (6-PIN only)
"F"	Low profile surface mount leadform (6-PIN only)
"SR2"	Tape and Reel for standard profile S/M (6-PIN only)
"FR2"	Tape and Reel for low profile S/M (6-PIN only)
"T"	Wide spaced 0.400" leadform (6-PIN only)
"L"	Solder dipped standard through hole (6-PIN only)
"V"	VDE 0884(1) tested and marked (6-PIN only)*
"R1"	500 piece Tape and Reel (SOIC-8 only)
"R2"	2500 piece Tape and Reel (SOIC-8 only)

Note: All of the above special option suffixes will be marked on Rails, Reels, and boxes.

*"V" suffix devices have a special partial discharge test and are marked with the VDE logo and 0884. The "V" will not be marked on the device.

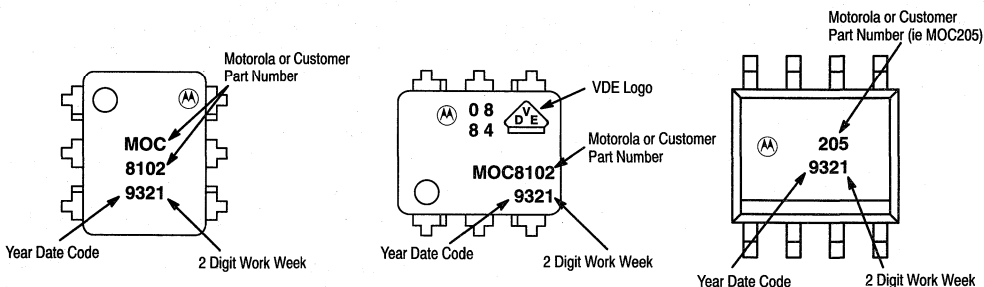

Standard 6-PIN Optoisolator Marking

"V" Suffix 6-PIN Optoisolator (VDE0884 Marking)

Small Outline SOIC-8 Optoisolator Marking

Device No.	Marking
4N25	4N25
4N25A	4N25A
4N26	4N26
4N27	4N27
4N28	4N28
4N29	4N29
4N29A	4N29A
4N30	4N30
4N31	4N31
4N32	4N32
4N32A	4N32A
4N33	4N33
4N35	4N35
4N36	4N36
4N37	4N37
4N38	4N38
4N38A	4N38A
CNX35	CNX35
CNX36	CNX36
CNX82	CNX82

Device No.	Marking
CNX83	CNX83
CNY17-1	CNY17-1
CNY17-2	CNY17-2
CNY17-3	CNY17-3
H11A1	H11A1
H11A2	H11A2
H11A3	H11A3
H11A4	H11A4
H11A5	H11A5
H11A520	H11A520
H11A550	H11A550
H11A5100	H11A5100
H11AA1	H11AA1
H11AA2	H11AA2
H11AA3	H11AA3
H11AA4	H11AA4
H11AV1	H11AV1
H11AV1A	H11AV1A
H11AV2	H11AV2
H11AV2A	H11AV2A

Device No.	Marking
H11AV3	H11AV3
H11AV3A	H11AV3A
H11B1	H11B1
H11B2	H11B2
H11B255	H11B255
H11D1	H11D1
H11D2	H11D2
H11G1	H11G1
H11G2	H11G2
H11G3	H11G3
H11L1	H11L1
H11L2	H11L2
H21A1	H21A1
H21A2	H21A2
H21A3	H21A3
H21B1	H21B1
H22A1	H22A1
H22A2	H22A2
H22A3	H22A3
H22B1	H22B1

Device No.	Marking
MCA230	MCA230
MCA231	MCA231
MCA255	MCA255
MCT2	MCT2
MCT2E	MCT2E
MCT271	MCT271
MCT272	MCT272
MCT273	MCT273
MCT274	MCT274
MCT275	MCT275
MFOD71	MFOD71
MFOD73	MFOD73
MFOD75	MFOD75
MFOE71	MFOE71
MFOE76	MFOE76
MLED91	01
MLED96	10
MLED97	08
MLED81	no marking
MLED930	MLED930

Device No.	Marking	Device No.	Marking	Device No.	Marking	Device No.	Marking
MOC2A40-5	MOC2A40-5	MOC216	216	MOC3082	MOC3082	MRD500	MRD500
MOC2A40-5F	MOC2A40-5F	MOC217	217	MOC3083	MOC3083	MRD510	MRD510
MOC2A40-10	MOC2A40-10	MOC221	221	MOC5007	MOC5007	MRD821	no marking
MOC2A40-10F	MOC2A40-10F	MOC222	222	MOC5008	MOC5008	MRD901	07
MOC2A60-5	MOC2A60-5	MOC223	223	MOC5009	MOC5009	MRD911	03
MOC2A60-5F	MOC2A60-5F	MOC3009	MOC3009	MOC8020	MOC8020	MRD921	05
MOC2A60-10	MOC2A60-10	MOC3010	MOC3010	MOC8021	MOC8021	MRD950	12
MOC2A60-10F	MOC2A60-10F	MOC3011	MOC3011	MOC8050	MOC8050	MRD3010	MRD3010
MOC70H1	MOC70H1	MOC3012	MOC3012	MOC8060	MOC8060	MRD3050	MRD3050
MOC70H2	MOC70H2	MOC3020	MOC3020	MOC8080	MOC8080	MRD3056	MRD3056
MOC70P1	MOC70P1	MOC3021	MOC3021	MOC8100	MOC8100	MRD5009	MRD5009
MOC70P2	MOC70P2	MOC3022	MOC3022	MOC8101	MOC8101	SL5500	SL5500
MOC70V1	MOC70V1	MOC3023	MOC3023	MOC8102	MOC8102	SL5501	SL5501
MOC70W1	MOC70W1	MOC3031	MOC3031	MOC8103	MOC8103	TIL111	TIL111
MOC75T1	MOC75T1	MOC3032	MOC3032	MOC8104	MOC8104	TIL112	TIL112
MOC119	MOC119	MOC3033	MOC3033	MOC8111	MOC8111	TIL113	TIL113
MOC205	205	MOC3041	MOC3041	MOC8112	MOC8112	TIL116	TIL116
MOC206	206	MOC3042	MOC3042	MOC8113	MOC8113	TIL117	TIL117
MOC207	207	MOC3043	MOC3043	MOC8204	MOC8204	TIL119	TIL119
MOC211	211	MOC3061	MOC3061	MRD300	MRD300	TIL126	TIL126
MOC212	212	MOC3062	MOC3062	MRD310	MRD310		
MOC213	213	MOC3063	MOC3063	MRD360	MRD360		
MOC215	215	MOC3081	MOC3081	MRD370	MRD370		

Discrete Emitters/Detectors

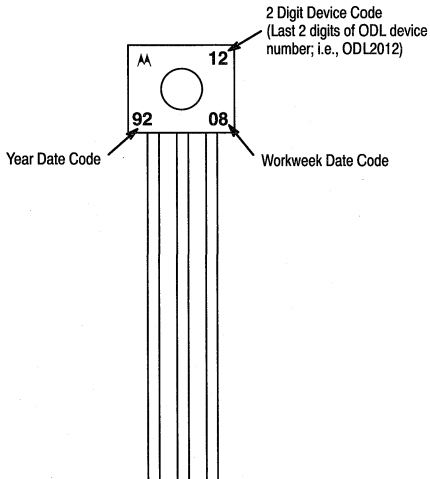

Device No.	Marking
MLED91	01
MRD911	03
MRD921	05
MRD901	07
MLED97	08
MLED96	10
MOC9000	11
MRD950	12

APPENDIX 3

The following devices are included in the Motorola Optoisolator portfolio, however they do not have individual dedicated Data Sheets. Refer to the suggested standard Data Sheet for typical electrical values and complete graphs.

Device Number	Refer to Data Sheet	Page #
TIL112	4N25	4-3
TIL111	4N25	4-3
H11A520	MOC8100	4-98
MCT2	4N25	4-3
MCT2E	4N25	4-3
TIL116	4N25	4-3
MCT271	CNY17-1	4-19
H11A550	MOC8100	4-98
TIL117	MOC8100	4-98
MCT275	CNY17-2	4-19

Device Number	Refer to Data Sheet	Page #
MCT272	MOC8100	4-98
H11A5100	4N35	4-11
MCT273	4N35	4-11
MCT274	CNY17-3	4-19
H11B255	4N30	4-7
MCA230	4N30	4-7
MCA255	4N30	4-7
MCA231	H11B2	4-34
TIL113	4N32	4-7
TIL119	MOC119	4-51

APPENDIX 4

Definitions, Characteristics, and Ratings

CTR	Current Transfer Ratio — The ratio of output current to input current, at a specified bias, of an opto coupler.
dv/dt	Commutating dv/dt — A measure of the ability of a triac to block a rapidly rising voltage immediately after conduction of the opposite polarity. Coupled dv/dt — A measure of the ability of an opto thyristor coupler to block when the coupler is subjected to rapidly changing isolation voltage.
E	Luminous Flux Density (Illuminance) (lumens/ft. ² = ft. candles) — The radiation flux density of wavelength within the band of visible light.
H	Radiation Flux Density (irradiance) (mW/cm ²) — The total incident radiation energy measured in power per unit area.
ICEO	Collector Dark Current — The maximum current through the collector terminal of the device measured under dark conditions, (H ≈ 0), with a stated collector voltage, load resistance, and ambient temperature. (Base open)
ID	Dark Current — The maximum reverse leakage current through the device measured under dark conditions, (H ≈ 0), with a stated reverse voltage, load resistance, and ambient temperature.
IFT	Input Trigger Current — Emitter current necessary to trigger the coupled thyristor.
IL	Collector Light Current — The device collector current measured under defined conditions of irradiance, collector voltage, load resistance, and ambient temperature.
Rs	Series Resistance — The maximum dynamic series resistance measured at stated forward current and ambient temperature.
SCR	Silicon Controlled Rectifier — A reverse blocking thyristor which can block or conduct in forward bias, conduction between the anode and cathode being initiated by forward bias of the gate cathode junction.
tf	Photo Current Fall Time — The response time for the photo-induced current to fall from the 90% point to the 10% point after removal of the GaAs (gallium-arsenide) source pulse under stated conditions of collector voltage, load resistance and ambient temperature.
tr	Photo Current Rise Time — The response time for the photo-induced current to rise from the 10% point to the 90% point when pulsed with the stated GaAs (gallium-arsenide) source under stated conditions of collector voltage, load resistance, and ambient temperature.
Triac	A thyristor which can block or conduct in either polarity. Conduction is initiated by forward bias of a gate-MTI junction.
Tstg	Storage Temperature
V(BR)R	Reverse Breakdown Voltage — The minimum dc reverse breakdown voltage at stated diode current and ambient temperature.
V(BR)CBO	Collector-Base Breakdown Voltage — The minimum dc breakdown voltage, collector to base, at stated collector current and ambient temperature (Emitter open and H ≈ 0)
V(BR)CEO	Collector-Emitter Breakdown Voltage — The minimum dc breakdown voltage, collector to emitter, at stated collector current and ambient temperature. (Base open and H ≈ 0)
V(BR)ECO	Emitter-Collector Breakdown Voltage — The minimum dc breakdown voltage, emitter to collector, at stated emitter current and ambient temperature. (Base open and H ≈ 0)
VCBO	Collector-Base Voltage — The maximum allowable value of the collector-base voltage which can be applied to the device at the rated temperature. (Base open)
VCEO	Collector-Emitter Voltage — The maximum allowable value of collector-emitter voltage which can be applied to the device at the rated temperature. (Base open)
VECO	Emitter-Collector Voltage — The maximum allowable value of emitter-collector voltage which can be applied to the device at the rated temperature. (Base open)
VF	Forward Voltage — The maximum forward voltage drop across the diode at stated diode current and ambient temperature.

APPENDIX 4 (Continued)

V_{ISO}	Isolation Surge Voltage — The dielectric withstanding voltage capability of an optocoupler under defined conditions and time.
V_R	Reverse Voltage — The maximum allowable value of dc reverse voltage which can be applied to the device at the rated temperature.
λ_s(μm)	Wavelength of maximum sensitivity in micrometers.

APPENDIX 5

Standard Warranty Clause

Seller warrants that its products sold hereunder will at the time of shipment be free from defects in material and workmanship, and will conform to Seller's approved specifications. If products are not as warranted, Seller shall, at its option and as Buyer's exclusive remedy, either refund the purchase price, or repair, or replace the product, provided proof of purchase and written notice of nonconformance are received within the applicable periods noted below and provided said nonconforming products are, with Seller's written authorization, returned in protected shipping containers FOB Seller's plant within thirty (30) days after expiration of the warranty period unless otherwise specified herein. If product does not conform to this warranty, Seller will pay for the reasonable cost of transporting the goods to and from Seller's plant. This warranty shall not apply to any products Seller determines have been, by Buyer or otherwise, subjected to improper testing, or have been the subject of mishandling or misuse.

THIS WARRANTY EXTENDS TO BUYER ONLY AND MAY BE INVOKED BY BUYER ONLY FOR ITS CUSTOMERS. SELLER WILL NOT ACCEPT WARRANTY RETURNS DIRECTLY FROM BUYER'S CUSTOMERS OR USERS OF BUYER'S PRODUCTS. THIS WARRANTY IS IN LIEU OF ALL OTHER WARRANTIES WHETHER EXPRESS, IMPLIED OR STATUTORY INCLUDING IMPLIED WARRANTIES OF MERCHANTABILITY OR FITNESS FOR A PARTICULAR PURPOSE.

Seller's warranty shall not be enlarged, and no obligation or liability shall arise out of Seller's rendering of technical advice and/or assistance.

- A. Time periods, products, exceptions and other restrictions applicable to the above warranty are:
- (1) Unless otherwise stated herein, products are warranted for a period of one (1) year from date of shipment.
 - (2) Device Chips/Wafers. Seller warrants that device chips or wafers have, at shipment, been subjected to electrical test/probe and visual inspection. Warranty shall apply to products returned to Seller within ninety (90) days from date of shipment. This warranty shall not apply to any chips or wafers improperly removed from their original shipping container and/or subjected to testing or operational procedures not approved by Seller in writing.
- B. Development products and Licensed Programs are licensed on an "AS IS" basis. IN NO EVENT SHALL SELLER BE LIABLE FOR ANY INCIDENTAL OR CONSEQUENTIAL DAMAGES.

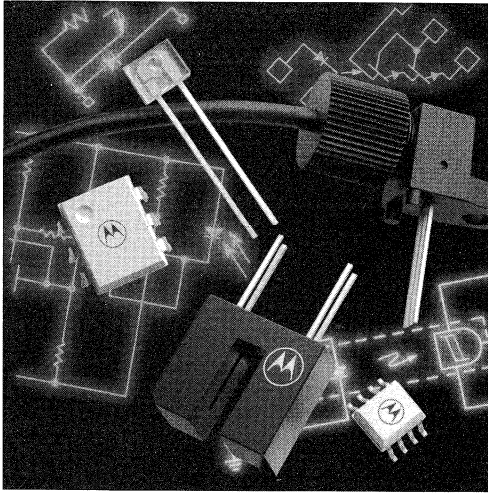

Section Fifteen

Index and Cross Reference

Index and Cross Reference

The following table represents a cross-reference guide for all Opto devices which are manufactured by Motorola. Where the Motorola part number differs from the Industry part number, the Motorola device is a "form, fit and function" replacement for the Industry part number; however, some differences in characteristics and/or specifications may exist.

Industry Part Number	Motorola Nearest Replacement	Motorola Similar Replacement	Page Number	Industry Part Number	Motorola Nearest Replacement	Motorola Similar Replacement	Page Number
2N25	4N25		4-3	CNX35	CNX35		4-19
2N25A	4N25A		4-3	CNY17-1	CNY17-1		4-19
2N5777		MRD911	7-30	CNY17-2	CNY17-2		4-19
2N5778		MRD911	7-30	CNY17-3	CNY17-3		4-19
2N5779		MRD911	7-30	CNY17-4		CNY17-3	4-19
2N5780		MRD911	7-30	CNY17-L	CNY17-2		4-19
				CNY17-M	CNY17-3		4-19
4N25	4N25		4-3	CNY17-N	CNY17-3		4-19
4N25A	4N25A		4-3	CNY17G-F-1		CNY17-1	4-19
4N26	4N26		4-3	CNY17G-F-2		CNY17-2	4-19
4N27	4N27		4-3	CNY17G-F-3		CNY17-3	4-19
4N28	4N28		4-3	CNY18	4N25		4-3
4N29	4N29		4-7	CNY21		4N25	4-3
4N29A	4N29A		4-7	CNY28		H21A1	8-2
4N30	4N30		4-7	CNY29		H21B1	8-6
4N31	4N31		4-7	CNY33		H11D1	4-38
4N32	4N32		4-7	CNY35		H11AA2	4-27
4N32A	4N32		4-7	CNY36		MOC70U1	8-10
4N33	4N33		4-7	CNY37		MOC70T1	8-10
4N35	4N35		4-11	CNY47		MCT271	
4N36	4N36		4-11	CNY47A		MCT271	
4N37	4N37		4-11	CNY48		4N32	4-7
4N38	4N38		4-15	CNY51		CNY17-3	4-19
4N38A	4N38A		4-15	CQY10		MLED930	7-11
5082-4203	MRD500		7-22	CQY11		MLED930	7-11
5082-4204	MRD500		7-22	CQY11B		MLED930	7-11
5082-4207	MRD500		7-22	CQY11C		MLED930	7-11
5082-4220	MRD500		7-22	CQY12		MLED930	7-11
BP101		MRD3050		CQY12B		MLED930	7-11
BP102		MRD3050		CQY13		4N26	4-3
BPW14	MRD300		7-16	CQY14		4N25	4-3
BPW24		MRD901	7-28	CQY15		4N26	4-3
BPW30	MRD360		7-19	CQY31		MLED930	7-11
BPW39A		MRD901	7-28	CQY32		MLED930	7-11
BPX25	MRD300		7-16	CQY40	4N26		4-3
BPX25A	MRD370		7-16	CQY41	4N26		4-3
BPX29	MRD310		7-16	CQY80		4N26	4-3
BPX29A	MRD370		7-16	CQY99		MLED81	7-2
BPX37	MRD300		7-16	CQY99		4N26	4-3
BPX38	MRD3055		7-16	EP2			
BPX43	MRD300		7-16	EPY62-1	MRD3055		
				EPY62-2	MRD3056		
BPX58	MRD300		7-16	EPY62-3	MRD310		7-16
BPX59	MRD360		7-19	FCD810	4N28		4-3
BPY62	MRD3055		7-11	FCD810A	4N28		4-3
CL100		MLED930	7-11	FCD810B	4N28		4-3
CL110	MLED930		7-11	FCD810C	4N28		4-3
CL110A	MLED930		7-11	FCD810D	4N28		4-3
CL110B		MLED930	7-11	FCD820	TIL116		
CLI-10		4N33	4-7	FCD820A	TIL116		
CLI-2		4N38	4-15	FCD820B	TIL116		
CLI-3		4N35	4-11	FCD820C	TIL116		
CLI-5			4-3	FCD820D	TIL116		
CLR2050	MRD3050		7-19	FCD825		TIL117	
CLR2060	MRD360		7-16	FCD825A		TIL117	
CLR2110	MRD310		7-16	FCD825B		TIL117	
CLR2140	MRD310		7-16	FCD825C		TIL117	
CLR2150	MRD300		7-16	FCD825D		TIL117	
CLR2160	MRD300		7-16	FCD830		TIL116	
CLR2170	MRD370		7-19	FCD830A		TIL116	
CLR2180	MRD360		7-19	FCD830B		TIL116	

Index and Cross Reference (continued)

Industry Part Number	Motorola Nearest Replacement	Motorola Similar Replacement	Page Number	Industry Part Number	Motorola Nearest Replacement	Motorola Similar Replacement	Page Number
FCD830C		TIL116		H11AV1A	H11AV1A		4-30
FCD830D		TIL116		H11AV2	H11AV2		4-30
FCD831		TIL116		H11AV2A	H11AV2A		4-30
FCD831A		TIL116		H11AV3	H11AV3		4-30
FCD831B		TIL116		H11AV3A	H11AV3A		4-30
FCD831C		TIL116		H11B1	H11B1		4-34
FCD831D		TIL116		H11B2	H11B2		4-34
FCD836		4N28	4-3	H11B255	H11B255		
FCD836C		4N28	4-3	H11D1	H11D1		4-38
FCD836D		4N28	4-3	H11D2	H11D2		4-38
FCD850		4N29	4-7	H11D3	H11D1		4-38
FCD850C		4N29	4-7	H11D4	H11D2		4-38
FCD850D		4N29	4-7	H11G1	H11G1		4-41
FCD855	H11B255			H11G2	H11G2		4-41
FCD855C	H11B255			H11G3	H11G3		4-41
FCD855D	H11B255			H11J1	MOC3011		4-55
FPE100	MLED930		7-11	H11J2	MOC3010		4-55
FPE410		MLED930	7-11	H11J3	MOC3011		4-55
FPE500		MLED830	7-11	H11J4	MOC3010		4-55
FPT120		MRD300	7-16	H11J5	MOC3010		4-55
FPT120C		MRD300	7-16	H11L1	H11L1		4-44
FPT400	MRD360		7-19	H11L2	H11L2		4-44
FPT450A		MRD300	7-16	H21A1	H21A1		8-2
FPT500	MRD300		7-16	H21A2	H21A2		8-2
FPT500A	MRD300		7-16	H21A3	H21A3		8-2
FPT510	MRD3054			H21A4		H21A1	8-2
FPT510A	MRD3055			H21A5		H21A2	8-2
FPT520	MRD300		7-16	H21B1	H21B1		8-6
FPT520A		MRD300	7-16	H21B2	H21B2		8-6
FPT530A	MRD300		7-16	H21B3	H21B3		8-6
FPT550A		MRD300	7-16	H22A1	H22A1		8-2
FPT560		MRD300	7-16	H22A2	H22A2		8-2
FPT570	MRD360		7-19	H22A3	H22A3		8-2
GE3009	MOC3009		4-55	H22A4		H22A1	8-2
GE3010	MOC3010		4-55	H22A5		H22A2	8-2
GE3011	MOC3011		4-55	H22B1	H22B1		8-6
GE3012	MOC3012		4-55	H22B2	H22B2		8-6
GE3020	MOC3020		4-59	H22B3	H22B3		8-6
GE3023	MOC3023		4-59	H22L1	MOC75U1		8-18
GEPS2001	H11A5		4-23	H22L2	MOC75U2		8-18
GFH600 I	CNY17-2		4-19	H23A1		MLED91+MRD901	7-4,7-28
GFH600 II	CNY17-3		4-19	H23A2		MLED91+MRD901	7-4,7-28
GFH600 III		CNY17-3	4-19	H23B1		MLED91+MRD901	7-4,7-28
GFH601 I	CNY17-1		4-19	H23L1		MLED91+MRD901	7-4,7-28
GFH601 II	CNY17-2		4-19	H2A6		H22A3	8-2
GFH601 III	CNY17-3		4-19	H74A1		4N26	4-3
GFH601 IV		CNY17-3	4-19	H74C1		MOC5008	4-79
GG686		MRD300	7-16	H74C2		MOC3020	4-59
GS600	MRD300		7-16	IL1		4N25	4-3
GS603	MRD300		7-16	IL12		4N35	4-11
GS606	MRD300		7-16	IL16		4N25	4-3
GS609	MRD300		7-16	IL2		CNY17-3	4-19
GS610	MRD300		7-16	IL201		CNY17-2	4-19
GS612	MRD3050			IL202		CNY17-2	4-19
GS670	MRD3050			IL205	MOC205		5-2
GS680	MRD300		7-16	IL206	MOC206		5-2
GS683	MRD300		7-16	IL207	MOC207		5-2
GS686	MRD300		7-16	IL211	MOC211		5-5
H11A1	H11A1		4-23	IL212	MOC212		5-5
H11A2	H11A2		4-23	IL213	MOC213		5-5
H11A3	H11A3		4-23	IL215	MOC215		5-8
H11A4	H11A4		4-23	IL216	MOC216		5-8
H11A5	H11A5		4-23	IL217	MOC217		5-8
H11A5100	H11A5100			IL221	MOC221		5-11
H11A520	H11A520			IL222	MOC222		5-11
H11A550	H11A550			IL223	MOC223		5-11
H11AA1	H11AA1		4-27	IL250	H11AA1		4-27
H11AA2	H11AA2		4-27	IL251	H11AA1		4-27
H11AA3	H11AA3		4-27	IL252	H11AA4		4-27
H11AA4	H11AA4		4-27	IL30	MCA230		4-27
H11AV1	H11AV1		4-30	IL31	MCA231		4-27

Index and Cross Reference (continued)

Industry Part Number	Motorola Nearest Replacement	Motorola Similar Replacement	Page Number	Industry Part Number	Motorola Nearest Replacement	Motorola Similar Replacement	Page Number		
IL410	MCA255	MOC3063	4-71	MFOD102F	MFOD1100	MFOD1100	9-15		
IL5		4N25	4-3	MFOD102F		MFOD1100	9-15		
IL55		4N35	4-11	MFOD104F		MFOD1100	9-15		
IL74			4N33	4-7		MFOD104F	MFOD1100	9-15	
ILA30			4N33	4-7		MFOD1100	MFOD1100	9-15	
ILA55	MCA230	MLED930	7-11	MFOD110F		MFOD1100	9-15		
ILCA2-30			7-19	MFOD202F		MFOD1100	9-15		
ILCA2-55	H11B255	MRD901	7-16	MFOD2202		MFOD1100	9-15		
IRL40	MRD360		7-16	MFOD2302			9-15		
L14F1			MRD370	7-16			MFOD2404	9-17	
L14F2	MRD300		7-16	MFOD2405	9-19				
L14G1	MRD310		7-16	MFOD302F	MFOD1100		9-15		
L14G2	MLED930		MRD901	7-28	MFOD404F		MFOD2404	9-17	
L14G3			MRD901	7-28	MFOD405F		MFOD2405	9-19	
L14H1			MRD901	7-28	MFOD71		MFOD71	9-2	
L14H2			MRD901	7-28	MFOD72		MFOD72	9-5	
L14H3			MRD901	7-11	MFOD73		MFOD73	9-8	
L14H4	MLED930	MRD360	7-11	MFOD75	MFOD75	9-11			
LED56			7-19	MFOD75	MFOD75	9-11			
LED56F	MLED930	MCA230	7-19	MFOD100WP	MFODC1100P	10-2			
MAH120	H11G1		4-41	MFOD102F	MFOD1100	MFODC1100P	9-30		
MCA11G1			H11G2	4-41		MFOD103F	MFOD1100	9-30	
MCA11G2			H11G3	4-41		MFOD106F	MFOD1100	9-30	
MCA11G3			MCA230	4N33		4-7	MFOD107F	MFOD1100	9-32
MCA2230			MCA230T			4-7	MFOD108F	MFOD1100	9-32
MCA2230Z	MCA230		4-7		MFOD1100	MFOD1100	9-26		
MCA2231			4N33		4-7	MFOD1101	MFOD1101	9-26	
MCA2255			4N33		4-7	MFOD1102	MFOD1102	9-26	
MCA230			MCA231	8-6	MFOD1200	MFOD1200	9-30		
MCA231		MCA255	4-55	MFOD1201	MFOD1201	9-32			
MCA255	H21B1	4-55	MFOD1202	MFOD1202	9-32				
MCA8	MOC3009	4-55	MFOD1203	MFOD1203	9-32				
MCP3009	MOC3010	4-55	MFOD1203	MFOD1203	9-32				
MCP3010	MOC3011	4-55	MFOD1203	MFOD1203	9-32				
MCP3011	MOC3012	MOC3011	4-55	MFOD1203	MFOD1203	9-32			
MCP3012		MOC3012	4-55	MFOD1203	MFOD1203	9-32			
MCP3020		MOC3020	4-55	MFOD1203	MFOD1203	9-32			
MCP3021		MOC3021	4-55	MFOD1203	MFOD1203	9-32			
MCP3022		MOC3022	4-55	MFOD1203	MFOD1203	9-32			
MCP3023		MOC3023	4-55	MFOD1203	MFOD1203	9-32			
MCP3023		MOC3023	4-55	MFOD1203	MFOD1203	9-32			
MCP3030		MOC3031	4-63	MFOD1203	MFOD1203	9-32			
MCP3031		MOC3031	4-63	MFOD1203	MFOD1203	9-32			
MCP3032		MOC3032	4-63	MFOD1203	MFOD1203	9-32			
MCP3033	MOC3033	4-63	MFOD1203	MFOD1203	9-32				
MCP3040	MOC3041	4-67	MFOD1203	MFOD1203	9-32				
MCP3041	MOC3041	4-67	MFOD1203	MFOD1203	9-32				
MCP3042	MOC3042	4-67	MFOD1203	MFOD1203	9-32				
MCP3043	MOC3043	4-67	MFOD1203	MFOD1203	9-32				
MCS2400	MCS2400	4-67	MFOD1203	MFOD1203	9-32				
MCT2	MCT2	4N35	4-11	MLED15	MLED91	7-4			
MCT210			MLED71	MLED91	7-4				
MCT2200			MLED76	MLED96	7-7				
MCT2201			MLED77	MLED97	7-9				
MCT2202			MLED81	MLED81	7-2				
MCT26			MLED92	MLED91	7-4				
MCT270			MLED93	MLED91	7-4				
MCT271			MLED930	MLED930	7-11				
MCT272			MLED94	MLED91	7-4				
MCT273			MLED95	MLED91	7-4				
MCT274	MLED95	MLED91	7-4						
MCT275	MLED95	MLED91	7-4						
MCT276	MLED95	MLED91	7-4						
MCT277	MLED95	MLED91	7-4						
MCT278	MLED95	MLED91	7-4						
MCT279	MLED95	MLED91	7-4						
MCT280	MLED95	MLED91	7-4						
MCT281	MLED95	MLED91	7-4						
MCT282	MLED95	MLED91	7-4						
MCT283	MLED95	MLED91	7-4						
MCT284	MLED95	MLED91	7-4						
MCT285	MLED95	MLED91	7-4						
MCT286	MLED95	MLED91	7-4						
MCT287	MLED95	MLED91	7-4						
MCT288	MLED95	MLED91	7-4						
MCT289	MLED95	MLED91	7-4						
MCT290	MLED95	MLED91	7-4						
MCT291	MLED95	MLED91	7-4						
MCT292	MLED95	MLED91	7-4						
MCT293	MLED95	MLED91	7-4						
MCT294	MLED95	MLED91	7-4						
MCT295	MLED95	MLED91	7-4						
MCT296	MLED95	MLED91	7-4						
MCT297	MLED95	MLED91	7-4						
MCT298	MLED95	MLED91	7-4						
MCT299	MLED95	MLED91	7-4						
MCT300	MLED95	MLED91	7-4						
MCT301	MLED95	MLED91	7-4						
MCT302	MLED95	MLED91	7-4						
MCT303	MLED95	MLED91	7-4						
MCT304	MLED95	MLED91	7-4						
MCT305	MLED95	MLED91	7-4						
MCT306	MLED95	MLED91	7-4						
MCT307	MLED95	MLED91	7-4						
MCT308	MLED95	MLED91	7-4						
MCT309	MLED95	MLED91	7-4						
MCT310	MLED95	MLED91	7-4						
MCT311	MLED95	MLED91	7-4						
MCT312	MLED95	MLED91	7-4						
MCT313	MLED95	MLED91	7-4						
MCT314	MLED95	MLED91	7-4						
MCT315	MLED95	MLED91	7-4						
MCT316	MLED95	MLED91	7-4						
MCT317	MLED95	MLED91	7-4						
MCT318	MLED95	MLED91	7-4						
MCT319	MLED95	MLED91	7-4						
MCT320	MLED95	MLED91	7-4						
MCT321	MLED95	MLED91	7-4						
MCT322	MLED95	MLED91	7-4						
MCT323	MLED95	MLED91	7-4						
MCT324	MLED95	MLED91	7-4						
MCT325	MLED95	MLED91	7-4						
MCT326	MLED95	MLED91	7-4						
MCT327	MLED95	MLED91	7-4						
MCT328	MLED95	MLED91	7-4						
MCT329	MLED95	MLED91	7-4						
MCT330	MLED95	MLED91	7-4						
MCT331	MLED95	MLED91	7-4						
MCT332	MLED95	MLED91	7-4						
MCT333	MLED95	MLED91	7-4						
MCT334	MLED95	MLED91	7-4						
MCT335	MLED95	MLED91	7-4						
MCT336	MLED95	MLED91	7-4						
MCT337	MLED95	MLED91	7-4						
MCT338	MLED95	MLED91	7-4						
MCT339	MLED95	MLED91	7-4						
MCT340	MLED95	MLED91	7-4						
MCT341	MLED95	MLED91	7-4						
MCT342	MLED95	MLED91	7-4						
MCT343	MLED95	MLED91	7-4						
MCT344	MLED95	MLED91	7-4						
MCT345	MLED95	MLED91	7-4						
MCT346	MLED95	MLED91	7-4						
MCT347	MLED95	MLED91	7-4						
MCT348	MLED95	MLED91	7-4						
MCT349	MLED95	MLED91	7-4						
MCT350	MLED95	MLED91	7-4						
MCT351	MLED95	MLED91	7-4						
MCT352	MLED95	MLED91	7-4						
MCT353	MLED95	MLED91	7-4						
MCT354	MLED95	MLED91	7-4						
MCT355	MLED95	MLED91	7-4						
MCT356	MLED95	MLED91	7-4						
MCT357	MLED95	MLED91	7-4						
MCT358	MLED95	MLED91	7-4						
MCT359	MLED95	MLED91	7-4						
MCT360	MLED95	MLED91	7-4						
MCT361	MLED95	MLED91	7-4						
MCT362	MLED95	MLED91	7-4						
MCT363	MLED95	MLED91	7-4						
MCT364	MLED95	MLED91	7-4						
MCT365	MLED95	MLED91	7-4						
MCT366	MLED95	MLED91	7-4						
MCT367	MLED95	MLED91	7-4						
MCT368	MLED95	MLED91	7-4						
MCT369	MLED95	MLED91	7-4						
MCT370	MLED95	MLED91	7-4						
MCT371	MLED95	MLED91	7-4						
MCT372	MLED95	MLED91	7-4						
MCT373	MLED95	MLED91	7-4						
MCT374	MLED95	MLED91	7-4						
MCT375	MLED95	MLED91	7-4						
MCT376	MLED95	MLED91	7-4						
MCT377	MLED95	MLED91	7-4						
MCT378	MLED95	MLED91	7-4						
MCT379	MLED95	MLED91	7-4						
MCT380	MLED95	MLED91	7-4						
MCT381	MLED95	MLED91	7-4						
MCT382	MLED95	MLED91	7-4						
MCT383	MLED95	MLED91	7-4						
MCT384	MLED95	MLED91	7-4						
MCT385	MLED95	MLED91	7-4						
MCT386	MLED95	MLED91	7-4						
MCT387	MLED95	MLED91	7-4						
MCT388	MLED95	MLED91	7-4						
MCT389	MLED95	MLED91	7-4						
MCT390	MLED95	MLED91	7-4						
MCT391	MLED95	MLED91	7-4						
MCT392	MLED95	MLED91	7-4						
MCT393	MLED95	MLED91	7-4						
MCT394	MLED95	MLED91	7-4						
MCT395	MLED95	MLED91	7-4						
MCT396	MLED95	MLED91	7-4						
MCT397	MLED95	MLED91	7-4						
MCT398	MLED95	MLED91	7-4						
MCT399	MLED95	MLED91	7-4						
MCT400	MLED95	MLED91	7-4						
MCT401	MLED95	MLED91	7-4						
MCT402	MLED95	MLED91	7-4						
MCT403	MLED95	MLED91	7-4						
MCT404	MLED95	MLED91	7-4						
MCT405	MLED95	MLED91	7-4						
MCT406	MLED95	MLED91	7-4						
MCT407	MLED95	MLED91	7-4						
MCT408	MLED95	MLED91	7-4						
MCT409	MLED95	MLED91	7-4						
MCT410	MLED95	MLED91	7-4						
MCT411	MLED95	MLED91	7-4						
MCT412	MLED95	MLED91	7-4						
MCT413	MLED95	MLED91	7-4						
MCT414	MLED95	MLED91	7-4						
MCT415	MLED95	MLED91	7-4						
MCT416	MLED95	MLED91	7-4						
MCT417	MLED95	MLED91	7-4						
MCT418	MLED95	MLED91	7-4						
MCT419	MLED95	MLED91	7-4						
MCT420	MLED95	MLED91	7-4						
MCT421	MLED95	MLED91	7-4						
MCT422	MLED95	MLED91	7-4						
MCT423	MLED95	MLED91	7-4						
MCT424	MLED95	MLED91	7-4						
MCT425	MLED95	MLED91	7-4						
MCT426	MLED95	MLED91	7-4						
MCT427	MLED95	MLED91	7-4						
MCT428	MLED95	MLED91	7-4						
MCT429	MLED95	MLED91	7-4						
MCT430	MLED95	MLED91	7-4						
MCT431	MLED95	MLED91	7-4						
MCT432	MLED95	MLED91	7-4						
MCT433	MLED95	MLED91	7-4						
MCT434	MLED95	MLED91	7-4						
MCT435	MLED95	MLED91	7-4						
MCT436	MLED95	MLED91	7-4						
MCT437	MLED95	MLED91	7-4						
MCT438	MLED95	MLED91	7-4						
MCT439	MLED95	MLED91	7-4						
MCT440	MLED95	MLED91	7-4						
MCT441	MLED95	MLED91	7-4						
MCT442	MLED95	MLED91	7-4						
MCT443	MLED95	MLED91	7-4						
MCT444	MLED95	MLED91	7-4						
MCT445	MLED95	MLED91	7-4						
MCT446	MLED95	MLED91	7-4						
MCT447	MLED95	MLED91	7-4						
MCT448	MLED95	MLED91	7-4						
MCT449	MLED95	MLED91	7-4						
MCT450	MLED95	MLED91	7-4						
MCT451	MLED95	MLED91	7-4						
MCT452	MLED95	MLED91	7-4						
MCT453	MLED95	MLED91	7-4						
MCT454	MLED95	MLED91	7-4						
MCT455	MLED95	MLED91	7-4						
MCT456	MLED95	MLED91							

Index and Cross Reference (continued)

Industry Part Number	Motorola Nearest Replacement	Motorola Similar Replacement	Page Number	Industry Part Number	Motorola Nearest Replacement	Motorola Similar Replacement	Page Number
MOC3021	MOC3021		4-59	MOC7823	MOC70J3		8-10
MOC3022	MOC3022		4-59	MOC8020	MOC8020		4-82
MOC3023	MOC3023		4-59	MOC8021	MOC8021		4-82
MOC3030	MOC3031		4-63	MOC8030	MOC8030		4-86
MOC3031	MOC3031		4-63	MOC8050	MOC8050		4-86
MOC3032	MOC3032		4-63	MOC8060	MOC8060		4-90
MOC3033	MOC3033		4-63	MOC8080	MOC8080		4-94
MOC3040	MOC3041		4-67	MOC8100	MOC8100		4-98
MOC3041	MOC3041		4-67	MOC8101	MOC8101		4-102
MOC3042	MOC3042		4-67	MOC8102	MOC8102		4-102
MOC3043	MOC3043		4-67	MOC8103	MOC8103		4-102
MOC3060	MOC3061		4-71	MOC8104	MOC8104		4-102
MOC3061	MOC3061		4-71	MOC8111	MOC8111		4-105
MOC3062	MOC3062		4-71	MOC8112	MOC8112		4-105
MOC3063	MOC3063		4-71	MOC8113	MOC8113		4-105
MOC3080	MOC3081		4-75	MOC8204	MOC8204		4-109
MOC3081	MOC3081		4-75	MOC8205	MOC8204		4-109
MOC3082	MOC3082		4-75	MOC8206	MOC8204		4-109
MOC3083	MOC3083		4-75	MRD14B		MRD911	7-30
MOC5007	MOC5007		4-79	MRD300	MRD300		7-16
MOC5008	MOC5008		4-79	MRD3010	MRD3010		
MOC5009	MOC5009		4-79	MRD3050	MRD3050		
MOC601A	4N27		4-3	MRD3051	MRD3051		
MOC601B	4N27		4-3	MRD3054	MRD3054		
MOC602A	4N26		4-3	MRD3055	MRD3055		
MOC602B	4N26		4-3	MRD3056	MRD3056		
MOC603A	4N35		4-11	MRD310	MRD310		7-16
MOC603B	4N35		4-11	MRD360	MRD360		7-19
MOC604A	4N35		4-11	MRD370	MRD370		
MOC604B	4N35		4-11	MRD500	MRD500		7-22
MOC622A	4N29		4-7	MRD5009	MRD5009		7-39
MOC623A	4N32		4-7	MRD510	MRD510		7-22
MOC624A	4N32		4-7	MRD701	MRD901		7-28
MOC625A	H11G2		4-41	MRD711	MRD911		7-30
MOC626A	MOC8030		4-86	MRD721	MRD921		7-32
MOC627A	MOC8050		4-86	MRD750	MRD950		7-35
MOC628A	MOC8050		4-86	MRD821	MRD821		7-25
MOC629A	MOC8021		4-82	MRDC100WP	MRDC100WP		10-8
MOC633A	MOC3020		4-59	MRDC200WP	MRDC200WP		10-10
MOC633B	MOC3020		4-59	MRDC400WP	MRDC400WP		10-12
MOC634A	MOC3021		4-59	MRDC600WP	MRDC600WP		10-15
MOC634B	MOC3021		4-59	MRDC800WP	MRDC800WP		
MOC635A	MOC3022		4-59	MTH320		MRD300	7-16
MOC635B	MOC3022		4-59	MTH321		MRD300	7-16
MOC640A	MOC3041		4-67	MTH420		MRD300	7-16
MOC640B	MOC3041		4-67	MTH421		MRD300	7-16
MOC641A	MOC3041		4-67	MTS360		MRD901	7-28
MOC641B	MOC3041		4-67	MTS361		MRD901	7-28
MOC660B	MOC3061		4-71	MTS460		MRD901	7-28
MOC661B	MOC3061		4-71	MTS461		MRD901	7-28
MOC662B	MOC3062		4-71	OP130	MLED930		7-11
MOC680B	MOC3081		4-75	OP131	MLED930		7-11
MOC681B	MOC3081		4-75	OP160	MLED81		7-2
MOC682B	MOC3082		4-75	OP160SL	MLED81		7-2
MOC70P2	MOC70P2			OP160SLA	MLED81		7-2
MOC70T1	MOC70T1		8-10	OP800	MRD3055		
MOC70T2	MOC70T2		8-10	OP801	MRD3050		
MOC70U1	MOC70U1		8-10	OP802	MRD310		7-16
MOC70U2	MOC70U2		8-10	OP803	MRD300		7-16
MOC70V1	MOC70V1		8-10	OP804	MRD300		7-16
MOC70W1	MOC70W1		8-13	OP805	MRD300		7-16
MOC71U1	MOC71U1		8-15	OP830	MRD300		7-16
MOC75T1	MOC75T1		8-18	OPB804		MOC70U1	8-10
MOC75T2	MOC75T2		8-18	OPB813		H21A1	8-2
MOC75U1	MOC75U1		8-18	OPB814		H21A2	8-2
MOC75U2	MOC75U2		8-18	OPB815		H21A3	8-2
MOC7811	MOC70T1		8-10	OPB816	H21A1		8-2
MOC7812	MOC70T2		8-10	OPB817	H21A3		8-2
MOC7813	MOC70T3		8-10	OPB818		MOC70U1	8-10
MOC7821	MOC70U1		8-10	OPB826S		MOC70W2	8-13
MOC7822	MOC70U2		8-10	OPB826SD		MOC70W1	8-13

Index and Cross Reference (continued)

Industry Part Number	Motorola Nearest Replacement	Motorola Similar Replacement	Page Number	Industry Part Number	Motorola Nearest Replacement	Motorola Similar Replacement	Page Number
OPB847		MOC70U1	8-10	SE1450-3		MLED930	7-11
OPB848		MOC70U1	8-10	SE1450-4		MLED930	7-11
OPB860		MOC70T1	8-10	SE2450-1		MLED930	7-11
OPB871N55		H21A1	8-2	SE2450-2		MLED930	7-11
OPB871T55		H21A2	8-2	SE2450-3		MLED930	7-11
OPB872N55		H21A3	8-2	SE2460-1		MLED930	7-11
OPB872T55		H22A1	8-2	SE2460-2		MLED930	7-11
OPB877T65		H22A2	8-2	SE2460-3		MLED930	7-11
OPI2150	4N28		4-3	SE5450-11	MLED930		7-11
OPI2151	4N28		4-3	SE5450-12	MLED930		7-11
OPI2152	4N26		4-3	SE5450-13	MLED930		7-11
OPI2153	TIL117			SE5450-14	MLED930		7-11
OPI2154	4N26		4-3	SE5451-1		MLED930	7-11
OPI2155	4N35		4-11	SE5451-2		MLED930	7-11
OPI2250	4N28		4-3	SE5451-3		MLED930	7-11
OPI2251	4N28		4-3	SFH600-0	CNY17-1		4-19
OPI2252	4N26		4-3	SFH600-1	CNY17-2		4-19
OPI2253	TIL117			SFH600-2	CNY17-3		4-19
OPI2254	4N26		4-3	SFH601-1	CNY17-1		4-19
OPI2255	4N35		4-11	SFH601-2	CNY17-2		4-19
OPI2500	H11AA1		4-27	SFH601-3	CNY17-3		4-19
OPI2501		H11AA1	4-27	SFH601G-1	CNY17-1T		4-19
OPI3009	MOC3009		4-55	SFH601G-2	CNY17-2T		4-19
OPI3010	MOC3010		4-55	SFH601G-3	CNY17-3T		4-19
OPI3011	MOC3011		4-55	SFH609-1		CNY17-1	4-19
OPI3012	MOC3012		4-55	SFH609-2		CNY17-2	4-19
OPI3020	MOC3020		4-59	SFH609-3		CNY17-3	4-19
OPI3021	MOC3021		4-59	SG1001		MLED930	7-11
OPI3022	MOC3022		4-59	SPX103	4N35		4-11
OPI3023	MOC3023		4-59	SPX103	4N35		4-11
OPI3030	MOC3031		4-63	SPX1872-1		MOC70U1	8-10
OPI3031	MOC3031		4-63	SPX1872-2		MOC70U1	8-10
OPI3032	MOC3032		4-63	SPX1873-1		MOC70T1	8-10
OPI3033	MOC3033		4-63	SPX1873-2		MOC70T1	8-10
OPI3040	MOC3041		4-67	SPX1876-1		MOC70T1	8-10
OPI3041	MOC3041		4-67	SPX1876-2		MOC70T1	8-10
OPI3042	MOC3042		4-67	SPX2	4N35		4-11
OPI3043	MOC3043		4-67	SPX26	4N27		4-3
OPI3150	4N33		4-7	SPX2762-4		MOC70U2	8-10
OPI3151	4N33		4-7	SPX28	4N27		4-3
OPI3152		MCA255		SPX2E	4N35		4-11
OPI3153		H11B1	4-34	SPX35	4N35		4-11
OPI3250	4N33		4-7	SPX36	4N35		4-11
OPI3251	4N33		4-7	SPX37	4N35		4-11
OPI3252		MCA255		SPX4	4N35		4-11
OPI3253		H11B1	4-34	SPX5	4N35		4-11
OPI5000	H11A520			SPX53	H11A550		
OPI5010	H11A520			SPX6	4N35		4-11
OPI6000	MOC8204		4-109	SPX7271	CNY17-1		4-19
OPI6100	MOC8204		4-109	SPX7272	CNY17-2		4-19
OPI8015	MOC5009		4-79	SPX7273	CNY17-3		4-19
PC503	4N26		4-3	SSL34		MLED930	7-11
SD1440-1		MRD3050		SSL4		MLED930	7-11
SD1440-2		MRD3050		SSL4F		MLED930	7-11
SD1440-3		MRD3050		SSL54		MLED930	7-11
SD1440-4		MRD3050		STP51	MRD3050		
SD3420-1	MRD510		7-22	STP53	MRD3056		
SD3420-2	MRD510		7-22	STPT260	MRD360		7-19
SD5400-1	MRD370			STPT300	MRD300		7-16
SD5400-2	MRD360		7-19	STPT310		MRD360	7-19
SD5400-3	MRD360		7-19	STPT80	MRD3056		
SD5420-1	MRD500		7-22	STPT81	MRD3052		
SD5440-1	MRD3052			STPT82	MRD3053		
SD5440-2				STPT83	MRD3054		
SD5440-3	MRD3056			STPT84	MRD3056		
SD5440-4	MRD300		7-16	TFH601-L		CNY17-2	4-19
SD5442-1		MRD300	7-16	TFH601-M		CNY17-3	4-19
SD5442-2		MRD300	7-16	TIL111	TIL111		
SD5442-3		MRD300	7-16	TIL112	TIL112		
SE1450-1		MLED930	7-11	TIL113	TIL113		
SE1450-2		MLED930	7-11	TIL114		4N35	4-11

Index and Cross Reference (continued)

Industry Part Number	Motorola Nearest Replacement	Motorola Similar Replacement	Page Number	Industry Part Number	Motorola Nearest Replacement	Motorola Similar Replacement	Page Number
TIL115		4N35	4-11	TLP3020	MOC3020		4-59
TIL116	TIL116			TLP3021	MOC3021		4-59
TIL117	TIL117			TLP3022	MOC3022		4-59
TIL118	4N35		4-11	TLP3023	MOC3023		4-59
TIL119	TIL119			TLP3031	MOC3031		4-63
TIL124	4N35		4-11	TLP3032	MOC3032		4-63
TIL125	4N35		4-11	TLP3033	MOC3033		4-63
TIL126	TIL126			TLP3041	MOC3041		4-67
TIL127		4N33	4-7	TLP3042	MOC3042		4-67
TIL128		MOC8111	4-105	TLP3043	MOC3043		4-67
TIL128A		4N32	4-7	TLP3061	MOC3061		4-71
TIL153	4N35		4-11	TLP3062	MOC3062		4-71
TIL154	4N35		4-11	TLP3063	MOC3063		4-71
TIL155	4N35		4-11	TLP501		4N27	4-3
TIL156		4N32	4-7	TLP503		4N25	4-3
TIL157		4N32	4-7	TLP504		4N25	4-3
TIL157A		4N32	4-7	TLP504		4N25	4-3
TIL181		CNY17-1	4-19	TLP535		CNY17-1	4-19
TIL186		H11AA1	4-27	TLP575		MOC8080	4-94
TIL187		MOC8060	4-90	TLP576		MOC8020	4-82
TIL189		MOC8080	4-94	TLP635		CNY17-2	4-19
TIL190		MOC8020	4-82	TLP635F		CNY17-2T	4-19
TIL23	MLED930		7-11	TLP636		MOC8112	4-105
TIL24		MLED930	7-11	TLP636F		MOC8112T	4-105
TIL31		MLED930	7-11	TLP637		CNY17-3	4-19
TIL33		MLED930	7-11	TLP637F		CNY17-3T	4-19
TIL34	MLED930		7-11	TLP639		H11AA2	4-27
TIL63	MRD3050			TLP639F		H11AA2T	4-27
TIL64	MRD3050			TLP665G		MOC3022	4-59
TIL65	MRD3052			TLP666G	MOC3042		4-67
TIL66	MRD3054			TLP666GF	MOC3042T		4-67
TIL67	MRD3056			TLP666J	MOC3062		4-71
TIL81	MRD300		7-16	TLP666JF	MOC3062T		4-71
TLP153	4N35		4-11	TLP675		MOC8080	4-94
TLP154	4N35		4-11	TLP675F		MOC8080T	4-94
TLP155	4N35		4-11	TLP676		MOC8020	4-82
TLP3009	MOC3009		4-55	TLP676F		MOC8020T	4-82
TLP3010	MOC3010		4-55	TLP677		H11G1	4-41
TLP3011	MOC3011		4-55	TLP677F		H11G1T	4-41
TLP3012	MOC3012		4-55	TLP735		CNY17-2	4-19
				TLP735F		CNY17-2T	4-19

- 1 Introduction**
- 2 Quality and Reliability**
- 3 Selector Guide**
- 4 Optoisolators/Optocouplers Data Sheets**
- 5 POWER OPTO Isolators Data Sheets**
- 6 SOIC-8 Small Outline Optoisolators Data Sheets**
- 7 Discrete Emitters/Detectors Data Sheets**
- 8 Slotted Optical Switches Data Sheets**
- 9 Fiber Optics Data Sheets**
- 10 Emitter/Detector Chips Data Sheets**
- 11 Applications Information**
- 12 Tape and Reel Specifications and Surface Mount Package Information**
- 13 Package Outline Dimensions**
- 14 Appendices**
- 15 Index and Cross Reference**



MOTOROLA

Literature Distribution Centers:

USA: Motorola Literature Distribution; P.O. Box 20912; Phoenix, Arizona 85036.

EUROPE: Motorola Ltd.; European Literature Centre; 88 Tanners Drive, Blakelands, Milton Keynes, MK14 5BP, England.

JAPAN: Nippon Motorola Ltd.; 4-32-1, Nishi-Gotanda, Shinagawa-ku, Tokyo 141 Japan.

ASIA-PACIFIC: Motorola Semiconductors H.K. Ltd.; Silicon Harbour Center, No. 2 Dai King Street, Tai Po Industrial Estate,
Tai Po, N.T., Hong Kong.

